

# ONKYO

# TX-NR636

## AV RECEIVER

# Advanced Manual

## CONTENTS

|   |           |   |           |   |           |
|---|-----------|---|-----------|---|-----------|
| <b>AM/FM Radio Receiving Function</b>                           | <b>2</b>  | <b>Using Remote Controller for Playing Music Files</b>    | <b>15</b> | TV operation  | 42        |
| Tuning into a Radio Station                                     | 2         | About the Remote Controller                               | 15        | Blu-ray Disc player/DVD player/DVD recorder operation | 42        |
| Presetting an AM/FM Radio Station                               | 2         | Remote Controller Buttons                                 | 15        | VCR/PVR operation                                     | 43        |
| Using RDS (European, Australian and Asian models)               | 3         | Icons Displayed during Playback                           | 15        | Satellite receiver / Cable receiver operation         | 43        |
| <b>Playing Content from a USB Storage Device</b>                | <b>4</b>  | <b>Using the Listening Modes</b>                          | <b>16</b> | CD player operation                                   | 44        |
| <b>Listening to Internet Radio</b>                              | <b>5</b>  | Selecting Listening Mode                                  | 16        | Cassette tape deck operation                          | 44        |
| About Internet Radio  | 5         | Contents of Listening Modes                               | 17        | To operate CEC-compatible components                  | 44        |
| TuneIn  | 5         | Checking the Input Format                                 | 19        | <b>Advanced Speaker Connection</b>                    | <b>45</b> |
| Pandora®-Getting Started (U.S., Australia and New Zealand only) | 6         | <b>Advanced Settings</b>                                  | <b>20</b> | Bi-Amping   | 45        |
| SiriusXM Internet Radio (North American only)                   | 7         | How to Set  | 20        | <b>Connecting and Operating Onkyo RI Components</b>   | <b>46</b> |
| Slacker Personal Radio (North American only)                    | 8         | 1.Input/Output Assign                                     | 21        | About RI Function                                     | 46        |
| Registering Other Internet Radios                               | 9         | 2.Speaker Setup   | 24        | RI Connection and Setting                             | 46        |
| <b>DLNA Music Streaming</b>                                     | <b>11</b> | 3.Audio Adjust  | 27        | iPod/iPhone Operation                                 | 47        |
| About DLNA  | 11        | 4.Source Setup  | 29        | <b>Firmware Update</b>                                | <b>48</b> |
| Configuring the Windows Media Player                            | 11        | 5.Listening Mode Preset                                   | 32        | About Firmware Update                                 | 48        |
| DLNA Playback   | 11        | 6.Miscellaneous   | 33        | Updating the Firmware via Network                     | 48        |
| Controlling Remote Playback from a PC                           | 12        | 7.Hardware Setup  | 33        | Updating the Firmware via USB                         | 49        |
| <b>Music Streaming from a Shared Folder</b>                     | <b>13</b> | 8.Remote Controller Setup                                 | 39        | <b>Troubleshooting</b>                                | <b>51</b> |
| About Shared Folder   | 13        | 9.Lock Setup  | 39        | <b>Reference Information</b>                          | <b>58</b> |
| Setting PC  | 13        | <b>Operating Other Components Using Remote Controller</b> | <b>40</b> |   |           |
| Playing from a Shared Folder                                    | 13        | Functions of REMOTE MODE Buttons                          | 40        |   |           |
|   |           | Programming Remote Control Codes                          | 40        |   |           |

# AM/FM Radio Receiving Function

## Tuning into a Radio Station

### ■ Tuning into stations automatically

1. Press TUNER on the main unit several times to select either "AM" or "FM".

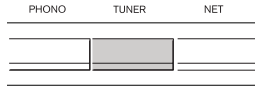

2. Press TUNING MODE so that the "AUTO" indicator on the display lights.

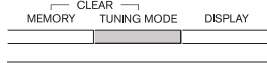

3. Press ▼TUNING▲ to start Auto tuning.
  - Searching automatically stops when a station is found. When tuned into a radio station, the "▶TUNED◀" indicator on the display lights. When tuned into an FM radio station, the "FM STEREO" indicator lights.
  - No sound is output while the "▶TUNED◀" indicator is off.

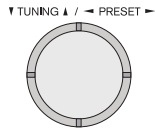

**When the signal from an FM radio station is weak:** Radio wave may be weak depending on the building structure and environmental conditions. In that case, manually tune into the radio station of your choice by referring to the next section.

### ■ Tuning into stations manually

1. Press TUNER on the main unit several times to select either "AM" or "FM".

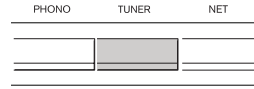

2. Press TUNING MODE so that the "AUTO" indicator on the display goes off.

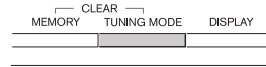

3. Press ▼TUNING▲ to select the desired radio station.
  - The frequency changes by 1 step each time you press the button. The frequency changes continuously if the button is held down and stops when the button is released. Tune by looking at the display.

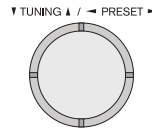

**To return the indicator to "AUTO":** Press TUNING MODE again on the main unit. The unit automatically tunes into an FM station. Normally, leave the indicator in "AUTO".

### ■ Tuning into stations by frequency

It allows you to directly enter the frequency of the radio station you want to listen to.

1. Press TUNER on the remote controller several times to select either "AM" or "FM".

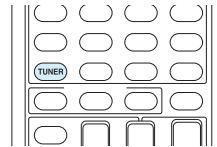

## AM/FM Radio Receiving Function

2. Press D.TUN.

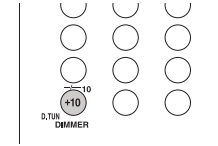

3. Using the number buttons, enter the frequency of the radio station within 8 seconds.
  - To enter 87.5 (FM), for example, press 8, 7, 5, or 8, 7, 5, 0. If you entered a wrong number, you can enter a correct one after 8 seconds.

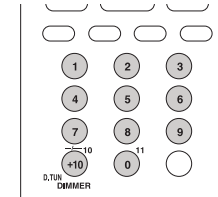

## Presetting an AM/FM Radio Station

It allows you to register up to 40 of your favorite AM/FM radio stations. Registering radio stations in advance allows you to tune into your radio station of choice directly.

### ■ Registering a Station

1. Tune into the AM/FM radio station you want to register.
2. Press MEMORY on the unit so that the preset number on the display flashes.

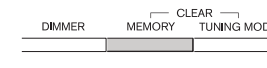

3. Repeatedly press ◀PRESET▶ to select a number between 1 and 40 while the preset number is flashing (about 8 seconds).

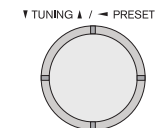

4. Press MEMORY again to register the station.

- When registering, the preset number stops flashing.
- Repeat this procedure for all of your favorite AM/FM radio stations.

### ■ Selecting a Preset Radio Station

1. Press CH +/- on the remote controller to select a preset number.

- Alternatively you can press ◀PRESET▶ on the main unit. You can also select by directly entering the preset number with the number buttons on the remote controller.

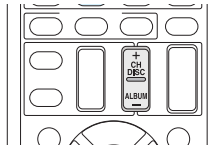

### ■ Deleting a Preset Radio Station

1. Press CH +/- on the remote controller to select the preset number to delete.

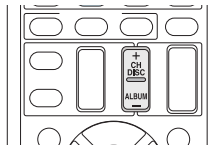

2. Press and hold MEMORY on the main unit and press TUNING MODE to delete the preset number.

- When deleting, the number on the display goes off.

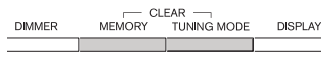

### Using RDS (European, Australian and Asian models)

RDS stands for Radio Data System and is a method of transmitting data in FM radio signals.

- RDS works only in areas where RDS broadcasts are available.
- In some cases, the text information appeared on the display is not identical to the content transmitted by the RDS station. Furthermore, unexpected characters may be displayed when the unit receives unsupported characters. However, this is not a malfunction.
- If the signal from an RDS station is weak, the RDS data may be displayed continuously or not at all.

**PS (Program Service):** Tuning into a radio station distributing Program Service information displays the radio station name. Pressing DISPLAY displays the frequency for 3 seconds.

**RT (Radio Text):** Tuning into a radio station transmitting Radio Text information displays text on the display of the unit.

**PTY (Program Type):** Allows you to search for RDS stations by program type.

**TP (Traffic Program):** Allows you to search for radio stations transmitting traffic information.

### ■ Displaying Radio Text (RT)

1. Press RT/PTY/TP on the main unit once.

- The Radio Text (RT) is displayed scrolling across the display. "No Text Data" is displayed when no text information is available.



### ■ Searching by Type (PTY)

1. Press RT/PTY/TP on the main unit twice.

- The current program type appears on the display.



2. Press ◀PRESET▶ to select the type of program to search for.

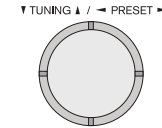

- The following RDS station types are displayed:

None  
 News (News reports)  
 Affairs (Current affairs)  
 Info (Information)  
 Sport  
 Educate (Education)  
 Drama  
 Culture  
 Science (Science and technology)  
 Varied  
 Pop M (Pop music)  
 Rock M (Rock music)  
 Easy M (Middle of the road music)  
 Light M (Light classics)  
 Classics (Serious classics)  
 Other M (Other music)  
 Weather  
 Finance  
 Children (Children's programmes)  
 Social (Social affairs)  
 Religion  
 Phone In  
 Travel  
 Leisure  
 Jazz (Jazz music)  
 Country (Country music)  
 Nation M (National music)  
 Oldies (Oldies music)

Folk M (Folk music)

Document (Documentary)

- Press ENTER to search the radio stations of the selected type.

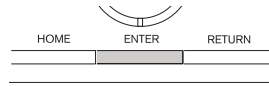

- When the desired radio station is found, the station name on the display flashes. Then, press ENTER again.
  - If no stations are found, the message "Not Found" is displayed.

### ■ Listening to Traffic Information (TP)

- Press RT/PTY/TP on the main unit thrice.
  - When the traffic information is transmitted from the radio station you selected, "[TP]" is displayed. "TP" only is displayed if no traffic information is available.



- Press ENTER to search a radio station distributing traffic information.

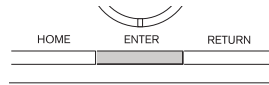

- When such a radio station is found, the indication on the display flashes. Then, press ENTER again.
  - "Not Found" is displayed if no radio station distributing traffic information is found.

## Playing Content from a USB Storage Device

- Operation:** You can set up by viewing the guidance displayed on the TV screen. To display the guidance, you need to make HDMI connection between the unit and TV. Select the item with the cursor buttons of the remote controller and press ENTER to confirm your selection. To return to the previous screen, press RETURN.

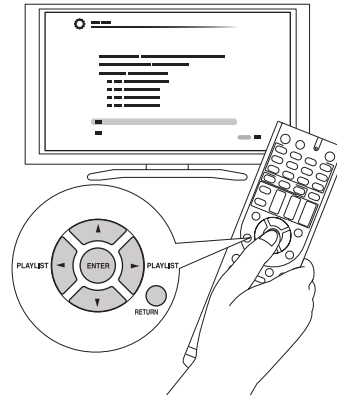

### ■ Playing Back

- Press USB on the remote controller to select "USB".

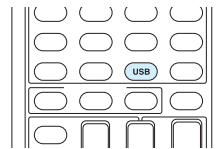

- Plug your USB storage device with the music files into the USB port of the unit so that "USB" lights on the display.
  - If the "USB" indicator flashes, check whether the USB storage device is plugged in properly.

- Do not unplug the USB storage device while "Connecting..." is appeared on the display. This may cause data corruption or malfunction.

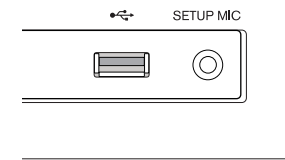

- Press ENTER.
  - The list of folders and music files on the USB storage device is displayed on the screen, select the folder with the cursors and press ENTER to confirm your selection.
- With the cursors, select the music file to play, and then press ENTER or ► to start playback.

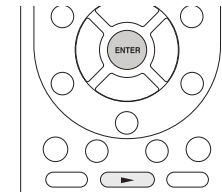

## Listening to Internet Radio

### About Internet Radio

Internet radio, also called net radio, web radio or streaming radio, is an audio service accessible at the websites of service providers who distribute music and audio programs in digital format. There are numerous websites all over the world, from terrestrial station, special station to personal website that provide such a service.

The unit comes preset with Internet radio stations (\*) such as Tuneln for you to enjoy these services, just by connecting the unit to the Internet.

\* Network services or contents may become unavailable if the service provider terminates its service.

### Tuneln

With more than 70,000 radio stations and 2 million on-demand programs registered, Tuneln is a service where you can enjoy music, sports and news from all over the world.

● **Operation:** You can set up by viewing the guidance displayed on the TV screen. To display the guidance, you need to make HDMI connection between the unit and TV. Select the item with the cursor buttons of the remote controller and press ENTER to confirm your selection. To return to the previous screen, press RETURN.

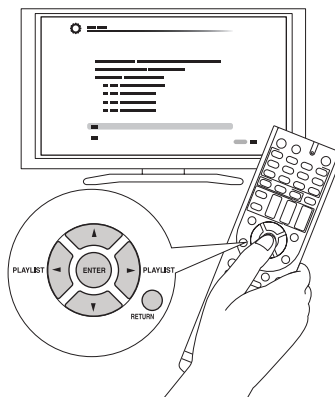

### ■ Playing Back

1. Press NET on the remote controller to display NET TOP screen.
  - "NET" lights on the display.
  - Alternatively you can press Home and select "Network Service" in the Home menu.

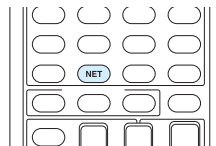

2. With the cursors, select "Tuneln", and then press ENTER to display Tuneln top screen.

3. With the cursors, select a radio station or program and press ENTER to start playing.

### ■ Regarding the Tuneln Menu

To display the Tuneln menu, press MENU while playing a radio station, or select "Go to Menu" and press ENTER. Selecting the corresponding menu item with the cursors and pressing ENTER allows you to perform the following operations:

**Add to My Presets:** Registers radio stations and programs in your "My Presets" within Tuneln. This allows you to play registered radio stations and programs with a simple operation. ("My Presets" is not displayed if it is empty.)

**Remove from My Presets:** Deletes a radio station or program from your "My Presets" within Tuneln.

**Report a problem:** Reports a problem or interactively solves a problem related to Tuneln.

**View Schedule:** Displays the radio station or program schedule.

**Clear recents:** Clears all radio stations and programs from the "Recents" within Tuneln. (This menu is displayed only when a radio station or program inside the "Recents" is being played.)

**Add to My Favorites:** Registers radio stations and programs in "My Favorites" of "Network Service". This allows you to play registered radio stations and programs with a simple operation.

## ■ Regarding the Tuneln Account

Creating an account on the Tuneln website (tunein.com) and logging in from the unit allows you to automatically add radio stations and programs to your "My Presets" on the unit as you save them on the website.

To display a radio station registered in "My Presets", you must log into Tuneln from the unit. To log in, select "Login" - "I have a Tuneln account" in the "Tuneln" top list on the unit, and then enter your user name and password.

- If you associate the device on My Page within the Tuneln website using the registration code obtained by selecting "Login" - "Login with a registration code" on the unit, you can log in without entering the user name and password.

## Pandora®—Getting Started (U.S., Australia and New Zealand only)

Pandora is a free, personalized Internet radio service that plays the music you know and helps you discover music you'll love.

● **Operation:** You can set up by viewing the guidance displayed on the TV screen. To display the guidance, you need to make HDMI connection between the unit and TV. Select the item with the cursor buttons of the remote controller and press ENTER to confirm your selection. To return to the previous screen, press RETURN.

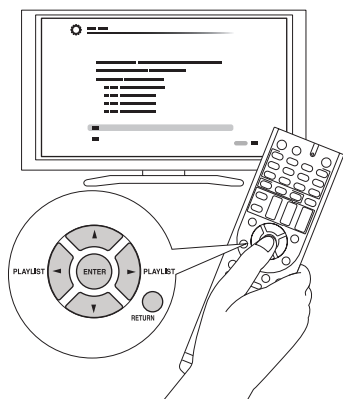

## ■ Playing Back

1. Press NET on the remote controller. The NET TOP screen displays and the "NET" indicator on the unit's display lights. To display the NET TOP screen, you can alternatively press HOME, select "Network Service" on the displayed Home menu, and then press ENTER.

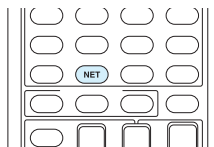

2. With the cursors on the remote controller, select "Pandora", and then press ENTER.
3. Use ▲/▼ to select "I have a Pandora Account" or "I'm new to Pandora" and then press ENTER. If you are new to Pandora select "I'm new to Pandora". You will see an activation code on your TV screen. Please write down this code. Go to an Internet connected computer and point your browser to [www.pandora.com/onkyo](http://www.pandora.com/onkyo). Enter your activation code and then follow the instructions to create your Pandora account and your personalized Pandora stations. You can create your stations by entering your favorite tracks and artists when prompted. After you have created your account and stations you can return to your Onkyo receiver and press enter to begin listening to your personalized Pandora. If you have an existing Pandora account, you can add your Pandora account to your Onkyo receiver by selecting "I have a Pandora Account" and logging in with your email and password.
  - If you want to use multiple user accounts, see "Using Multiple Accounts". Login can be made from the "Users" screen.
4. To play a station, use ▲/▼ to select the station from your station list, and then press ENTER. Playback starts and the playback screen appears.

## ■ Create a New Station

Enter the name of a track, artist, or genre and Pandora will create a unique radio station for you based on the musical qualities of that track, artist, or genre.

**I like this track:** Give a track "thumbs-up" and Pandora will play more music like it.

**I don't like this track:** Give a track "thumbs-down" and Pandora will ban that track from the current station.

**Why is this track playing?:** Discover some of the musical attributes that Pandora uses to create your personal radio stations.

**I'm tired of this track:** If you are tired of a track, you can put the track to sleep and Pandora will not play it for one month.

**Create station from this artist:** Creates a radio station from this artist.

**Create station from this track:** Creates a radio station from this track.

**Delete this station:** This will permanently delete a station from your Pandora account. All of your thumbs feedback will be lost should you choose to re-create the station with the same track or artist.

**Rename this station:** Lets you rename the current radio station.

**Bookmark this artist:** Pandora will bookmark your favorite artist for your profile on [www.pandora.com](http://www.pandora.com).

**Bookmark this track:** Pandora will bookmark the current track and allow you to buy them all from Amazon or iTunes in one step!

**Add to My Favorites:** Adds a station to My Favorites list.

## PANDORA

PANDORA, the PANDORA logo, and the Pandora trade dress are trademarks or registered trademarks of Pandora Media, Inc. Used with permission.

## SiriusXM Internet Radio (North American only)

If you want to listen to the service, you must subscribe. To subscribe go to [www.siriusxm.com/internetradio](http://www.siriusxm.com/internetradio) with your computer. When you subscribe, you will be provided with a username and password which has to be entered into the AV receiver. To use SiriusXM Internet Radio, you must have your AV receiver connected to the Internet. Using the remote control, follow these steps:

● **Operation:** You can set up by viewing the guidance displayed on the TV screen. To display the guidance, you need to make HDMI connection between the unit and TV. Select the item with the cursor buttons of the remote controller and press ENTER to confirm your selection. To return to the previous screen, press RETURN.

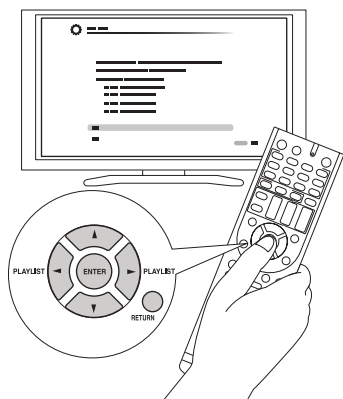

## ■ Playing Back

1. Press NET on the remote controller to display NET TOP screen.
  - "NET" indicator on the unit's display lights. To display the NET TOP screen, you can alternatively press HOME, select "Network Service" on the displayed Home menu, and then press ENTER.

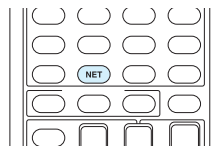

2. With the cursors on the remote controller, select "SiriusXM Internet Radio", and then press ENTER.
3. Select "Sign In", and then press ENTER. If you have an existing SIRIUS account, you can sign in by selecting "Sign In". Enter your user name and password in the next keyboard screen, or in Web Setup. If you don't know your username or password, call Sirius XM at (888) 539-7474 for assistance.
  - If you want to use multiple user accounts, see "Using Multiple Accounts". Login can be made from the "Users" screen.

### Using the keyboard screen

- ① Use ▲/▼/◀/▶ and ENTER to enter your user name and password.
- ② Select "OK".
- ③ Press ENTER. The "Confirm your entries" screen appears.
- ④ Press ENTER. "Please wait..." appears and then "SiriusXM Internet Radio" screen appears which displays the category available for selection.
4. Use ▲/▼ to select the category and then press ENTER. The channel list screen for the selected category appears.
5. Use ▲/▼ to select the desired channel and then press ENTER. The playback screen for the selected channel appears and you can listen to SiriusXM Internet Radio. You can control the tracks with the buttons on the remote control. Enabled buttons: ▶, ■, ◀◀, ▶▶

**Add to My Favorites:** Adds a channel to My Favorites list.

**Add to Presets:** Adds the currently playing station to presets list.

**Delete from Presets:** Deletes the currently playing station from presets list.



SiriusXM Internet Radio subscriptions are sold separately and are governed by the Sirius Terms and Conditions (see [www.sirius.com](http://www.sirius.com)). Be sure to read this agreement before you purchase your subscription. Sirius, XM and all related marks and logos are trademarks of Sirius XM Radio Inc. and its subsidiaries. All rights reserved.

## Slacker Personal Radio (North American only)

● **Operation:** You can set up by viewing the guidance displayed on the TV screen. To display the guidance, you need to make HDMI connection between the unit and TV. Select the item with the cursor buttons of the remote controller and press ENTER to confirm your selection. To return to the previous screen, press RETURN.

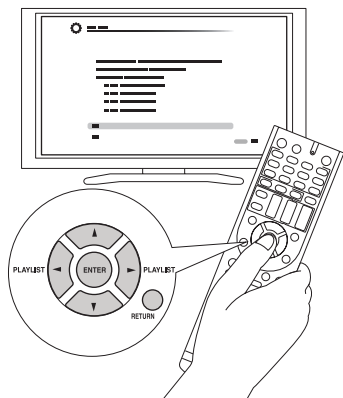

## ■ Playing Back

1. Press NET on the remote controller to display NET TOP screen.
  - "NET" indicator on the unit's display lights. To display the NET TOP screen, you can alternatively press HOME, select "Network Service" on the displayed Home menu, and then press ENTER.

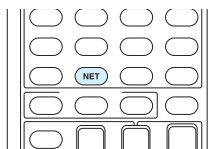

2. With the cursors on the remote controller, select "Slacker Personal Radio", and then press ENTER.

3. If you do not have an account, create one on the Slacker website ([www.slacker.com](http://www.slacker.com)) with your computer. If you already have a Slacker account, select "Sign in to your account" and then press ENTER. The keyboard screen appears. You can enter information from the remote control or the keys on the main unit.
4. If there are no mistakes in the information you have entered, use ▲/▼/◀/▶ to select "OK" then press ENTER. An account information confirmation screen appears.
5. If you do not have an account, select "Access without Sign In" and press ENTER to use a restricted version of the service. Note that use will be restricted.
  - If you want to use multiple user accounts, see "Using Multiple Accounts". Login can be made from the "Users" screen.
6. Use ▲/▼ to select a menu item and then press ENTER. To sign out, use ▲/▼ to select "Sign out" from this screen and then press ENTER.
7. Use ▲/▼ to select a station and then press ENTER or ▶ to start playback from the station. The playback screen appears.
8. You can control the tracks with the buttons on the remote control.  
Enabled buttons: ▶, II, ■, ▶▶

**Rate Song as Favorite:** Stores information to server, making it more likely that the song will be played again.

**Ban Song:** Stores information to server, making it less likely that the song will be played again.

**Ban Artist:** Stores information to server, making it less likely that the songs from this artist will be played again.

**Mark Favorite:** Adds the currently playing station to your favorites.

**Unmark Favorite:** Deletes the currently playing station from your favorites.

**Add song to Library:** Adds the currently playing track to your library.

**Delete song from Library:** Deletes the currently playing track from your library.

**Add to My Favorites:** Adds a station or song to My Favorites list.

**Using Multiple Accounts:** The AV receiver supports multiple user accounts, which means you can freely switch between several logins. After registering user accounts, login is performed from the "Users" screen.

Press MENU while the Users screen is displayed. "Add new user", "Remove this user" menu appear. You can either store a new user account, or delete an existing one.

- Some of the services don't allow the use of multiple user accounts.
- You can store up to 10 user accounts.
- To switch between accounts you must first log out from the current account, and log in again on the "Users" screen.



## Registering Other Internet Radios

To listen to other Internet radio program, register the program in the "My Favorites" list on the NET TOP screen as described below. The unit supports Internet radio stations stored in the following formats: PLS (URL ending in .pls), M3U (URL ending in .m3u) and RSS (URL ending in rss/rdf/xml).

- You can register up to 40 Internet radio stations.
- Depending on the data type and file format for playback, you may not be able to play an Internet radio station even when its format is PLS, M3U or Podcast (RSS).
- Available services may vary depending on your area of residence.

● **Operation:** You can set up by viewing the guidance displayed on the TV screen. To display the guidance, you need to make HDMI connection between the unit and TV. Select the item with the cursor buttons of the remote controller and press ENTER to confirm your selection. To return to the previous screen, press RETURN.

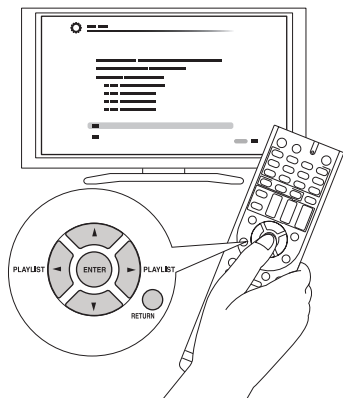

## Registering a Station

**Before operation:** The name and URL of the additional radio station will be needed for this procedure. Check the specifications before use.

1. Press NET on the remote controller to display NET TOP screen.
  - "NET" lights on the display.

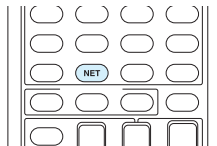

2. With the cursors, select "My Favorites", and then press ENTER to display the "My Favorites" list screen.
3. With the cursors, select a blank area of "My Favorites" and press MENU to display the menu screen.

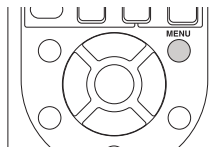

4. With the cursors, select "Create new station", and then press ENTER to display a keyboard screen.
5. Enter the name and URL of the radio station to add.
  - Select "Shift" and press ENTER to toggle between upper and lower case. Select "←" or "→" and press ENTER to move the cursor to the selected direction. Select "Back Space" and press ENTER to remove a character on the left of the cursor.

## Registering a Station with PC

**Before operation:** The name and URL of the additional radio station will be needed for this procedure. Check the specifications before use.

1. Press RCV on the remote controller.
  - Always press RCV first to change the remote controller to RECEIVER mode (the mode to operate this unit) since its mode may be changed to operate another component.

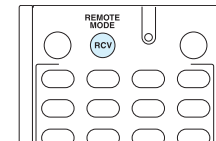

2. Press HOME to display the Home menu.

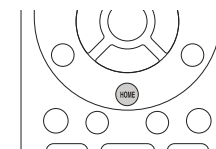

3. With the cursors, select "Setup", and then press ENTER.
4. With the cursors, select "7.Hardware Setup" - "Network" - "IP Address" to display the IP address.
  - Write down the IP address since you will need it later.
5. Open the Internet browser on your PC or smartphone and enter the IP address of the unit in the URL field. Information of the unit is displayed on the browser. ("WEB Setup")
  - If you are using Internet Explorer, you can also enter the URL by selecting "Open..." on the "File" menu.
6. Click "My Favorites" tab, then enter the name and URL of the Internet radio station.
7. Click "Save" to register the entered Internet radio station in "My Favorites".

**To rename the registered radio station:** While the radio station is being played or when it is selected from the "My Favorites" list, press MENU to display the menu screen. Select "Rename this station" with the cursors and press ENTER to display the keyboard screen. Rename the station as desired.

- Radio stations can be renamed also from "WEB Setup".

### ■ Playing a Registered Radio Station

1. Press NET on the remote controller to display NET TOP screen.

- "NET" lights on the display.

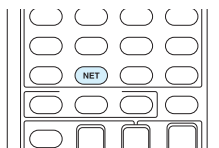

2. With the cursors, select "My Favorites", and then press ENTER to display the registered Internet radio stations.

3. With the cursors, select the radio station to delete and press MENU to display the menu screen.

### ■ Deleting a Registered Radio Station

1. Press NET on the remote controller to display NET TOP screen.

- "NET" lights on the display.

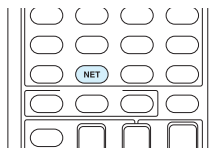

2. With the cursors, select "My Favorites", and then press ENTER to display the registered Internet radio stations.

3. With the cursors, select the radio station to delete and press MENU to display the menu screen.

- You can also display the menu screen by pressing MENU while the radio station is being played.

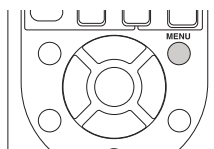

4. With the cursors, select "Delete from My Favorites", and then press ENTER.

- Radio stations can be deleted also from "WEB Setup".

## DLNA Music Streaming

### About DLNA

Digital Living Network Alliance (DLNA) can be referred to as a technology standard or the industry group to develop the technology standard to interconnect and use AV components, PCs and other devices in a home network (more precisely the technology standard is called the DLNA guidelines).

The unit allows you to use DLNA to play music files stored on a PC or a hard disk connected to your home network (NAS device). Make sure the unit and PC or NAS device are connected to the same router.

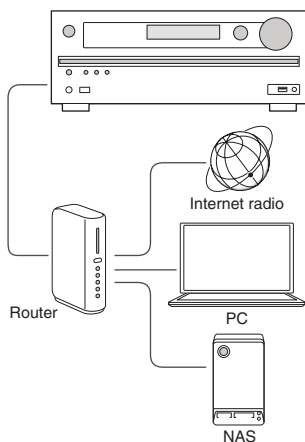

- To play a music file with DLNA, you need a NAS device or the like with DLNA server functions and a DLNA player (software) to stream the music. You can also stream music files using a PC installed with Windows Media Player 11 or 12 as they are equipped with both DLNA server and player functions. To enable streaming, you must first configure the Windows Media Player 11 or Windows Media Player 12.

- With Windows Media Player 12 Remote Playback function, you can stream music files stored on your PC to the unit by operating the PC.

### Configuring the Windows Media Player

#### ■ Windows Media Player 11

- Turn on your PC and start Windows Media Player 11.
- In the "Library" menu, select "Media Sharing" to open a dialog box.
- Select the "Share my media" check box, and then click "OK" to display a list of supported devices.
- Select this unit, and then click "Allow". The corresponding icon is checked.
- Click "OK" to close the dialog.

#### ■ Windows Media Player 12

- Turn on your PC and start Windows Media Player 12.
- Click "Turn on media streaming" to display a list of players in the network.
  - If media streaming is already turned on, select "More streaming options..." in the "Stream" menu to list players in the network. Proceed to step 4.
- Click "Turn on media streaming". A list of players in the network is displayed.
- Select this unit in "Media streaming options" and check that it is set to "Allow".
- Click "OK" to close the dialog.

### DLNA Playback

- Operation:** You can set up by viewing the guidance displayed on the TV screen. To display the guidance, you need to make HDMI connection between the unit and TV. Select the item with the cursor buttons of the remote controller and press ENTER to confirm your selection. To return to the previous screen, press RETURN.

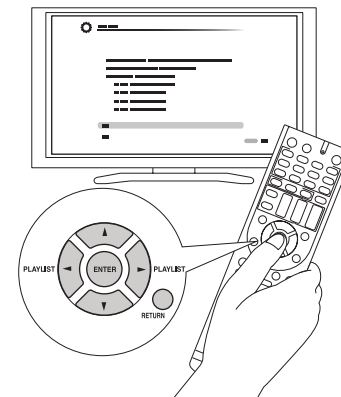

#### ■ Playing Back

- Start the server (Windows Media Player 11, Windows Media Player 12, or NAS device) storing the music files to play.
- Press NET on the remote controller to display NET TOP screen.
  - "NET" lights on the display. If the "NET" indicator flashes, the unit is not properly connected to the network. When using a wired LAN connection, check the Ethernet cable connection, and when using a wireless LAN connection, check whether the "Wi-Fi" indicator on the left side of the unit stays lit.

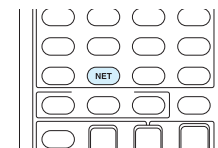

- Select "DLNA" with the cursors and press ENTER.
- With the cursors, select the target server, and then press ENTER to display a list of items on the selected server.
  - Searching does not work in servers that do not support search functions.
  - The unit cannot access pictures and videos stored on servers.
  - Contents stored on the server may not be displayed depending on the server sharing settings.

- With the cursors, select the music file to play, and then press ENTER or ► to start playback.
  - If "No Item" is displayed, check whether the network is properly connected.

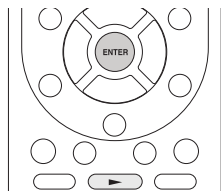

## Controlling Remote Playback from a PC

You can use this unit to play music files stored on your PC by operating the PC inside your home network. The unit supports remote playback with Windows Media Player 12. To use the remote playback function with Windows Media Player 12, Windows Media Player 12 must be configured in advance.

- Using a DLNA-compatible controller (such as an Android application), you can select a music file stored on Windows Media Player 12 and stream to this unit by operating the controller. For information on how to remotely play using the controller, refer to the controller's instruction manual.

## Setting PC

- Turn on your PC and start Windows Media Player 12.
- In the "Stream" menu, select "Turn on media streaming" to open a dialog box.
  - If media streaming is already turned on, select "More streaming options..." in the "Stream" menu to list players in the network. Proceed to step 4.
- Click "Turn on media streaming" to display a list of players in the network.
- Select this unit in "Media streaming options" and check that it is set to "Allow".
- Click "OK" to close the dialog box.
- Open the "Stream" menu and check that "Allow remote control of my Player..." is checked.

## Remote playback

- Turn on the power of the unit.
- Turn on your PC and start Windows Media Player 12.
- Select the music file to play with Windows Media Player 12 and right-click.
  - To remotely play a music file on another server, open the target server from "Other Libraries" and select the music file to play.
- Select this unit in "Play to" and open the "Play to" window of Windows Media Player 12 to start to playback music file on the unit.
  - Operations during remote playback are possible from the "Play to" window on the PC. The playback screen is displayed on the TV connected to the HDMI output of the unit. If your PC is running on Windows 8, click "Play to", and then select this unit.
- Adjust the volume using the volume bar on the "Play to" window.
  - Some times, the volume displayed on the remote playback window may differ from that appeared on the display of the unit.
  - When the volume is adjusted from the unit, the value is not reflected in the "Play to" window.
  - This unit cannot play music files remotely in the following conditions.
    - It is using a network service.
    - It is playing a music file on a USB storage device.
    - "Agree" was not selected in the DISCLAIMER screen that was displayed when the NET input was selected on the unit for the first time.

## Music Streaming from a Shared Folder

### About Shared Folder

A shared folder is configured in a network device such as a PC or NAS (hard disk connected to your home network) for access from other users.

You can play music files in a shared folder on your PC or NAS connected to the same home network as that of the unit. To play music files in a shared folder, you must first configure Windows 8 or Windows 7, Make sure the unit and PC or NAS device are connected to the same router.

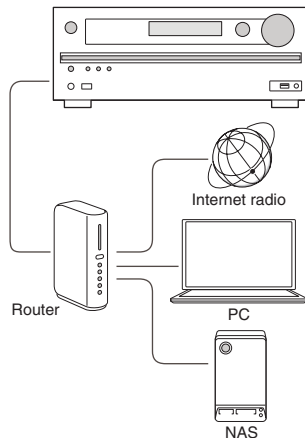

- The sharing options must be configured and a shared folder created on the PC in advance.
- For information on how to configure the NAS device and create a shared folder, refer to the NAS device's instruction manual.

### Setting PC

#### ■ Configuring the Sharing Options

1. Select "Choose Home group and Sharing Options" on the "Control Panel".
  - If the menu is not displayed, check whether "View by" is set to "Category".
2. Select "Change advanced sharing settings".
3. Check whether the following radio buttons are selected in "Home or Work":
  - "Enable network discovery"
  - "Turn on file and printer sharing"
  - "Turn on sharing so anyone with network access can read and write files in the Public folders"
  - "Turn off password protected sharing"
4. Select "Save Changes" and click "OK" on the dialog box.

#### ■ Creating a Shared Folder

1. Select the folder to share and right-click.
2. Select "Properties".
3. Select "Advanced Sharing" on the "Sharing" tab.
4. Select the "Share this folder" check box and click "OK".
5. Select "Share" for "Network File and Folder Sharing".
6. Select "Everyone" from the pull-down menu. Click "Add", and then "Share".
  - To set user name and password to a shared folder, set "Permissions" in "Advanced Sharing" on the "Sharing" tab.
  - Check whether a workgroup is set.

### Playing from a Shared Folder

- **Operation:** You can set up by viewing the guidance displayed on the TV screen. To display the guidance, you need to make HDMI connection between the unit and TV. Select the item with the cursor buttons of the remote controller and press ENTER to confirm your selection. To return to the previous screen, press RETURN.

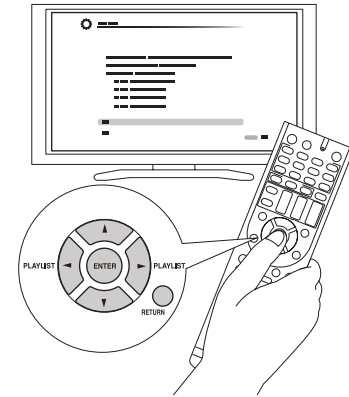

#### ■ Playing Back

1. Press NET on the remote controller to display NET TOP screen.
  - "NET" lights on the display.
  - If the "NET" indicator flashes, the unit is not properly connected to the network. When using a wired LAN connection, check the Ethernet cable connection, and when using a wireless LAN connection, check whether the "Wi-Fi" indicator on the left side of the unit is lit.

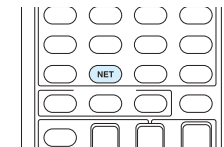

2. With the cursors, select "Home Media", and then press ENTER.
3. With the cursors, select the target server, and then press ENTER.
  - You can check the server name of your PC from the PC properties.
4. With the cursors, select the target shared folder, and then press ENTER.
5. If a username and password is required, enter the necessary login information.
  - The login information is the account information set at the time of creating the shared folder.
  - Once entered, the login information will be remembered from the next time onward.
6. With the cursors, select the music file to play, and then press ENTER or ► to start playback.

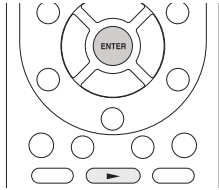

## Using Remote Controller for Playing Music Files

### About the Remote Controller

The remote controller of this unit allows you to play music files stored on USB storage devices, Internet radio, PCs and NAS devices on your home network, as well as on Bluetooth-enabled devices. It also allows you to view information of the music file being played and perform various other operations.

- Available buttons may vary depending on the service and device to play.
- Some buttons cannot be used with Bluetooth-enabled devices. Furthermore, the Bluetooth-enabled devices must support the AVRCP profile. Some devices may not be operated, even when they support AVRCP profile.

### Remote Controller Buttons

1. Press INPUT SELECTOR (PC, NET, USB or BLUETOOTH) appropriate for the input source on the remote controller.

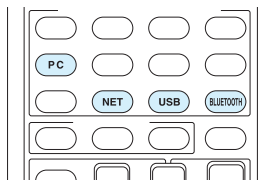

2. Operate the remote controller by referring to the name and function of each of the buttons below.

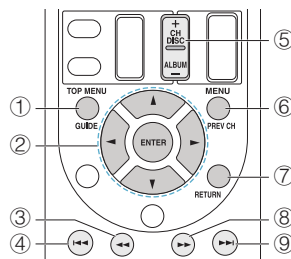

- 1 **TOP MENU**: This button displays the top menu for each media or server.
- 2 **▲/▼, ENTER**: These buttons navigate through items and activate the selected item.  
◀/▶: These buttons cycle through pages.
- 3 **◀◀**: This button fast-reverses the current track. This button is not operable from 10 seconds before the playback ends.
- 4 **◀◀**: This button plays the current track from the beginning. Pressing this button twice plays the previous track.
- 5 **CH +/- button**: Moves the cursor on the Internet radio stations list in "My Favorites".
- 6 **MENU**: This button displays the menu of each Internet radio service.
- 7 **RETURN**: This button returns to the previous screen.
- 8 **▶▶**: This button fast-forwards the current track. This button is not operable from 10 seconds before the playback ends.
- 9 **▶▶**: This button plays the next track.

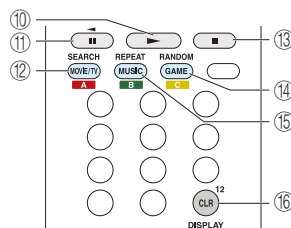

- 10 **▶**: This button starts the playback.
- 11 **||**: This button pauses the playback.

## Using Remote Controller for Playing Music Files

- 12 **SEARCH**: This button toggles between the playback screen and list screen during playback.
- 13 **■**: This button stops the playback.
- 14 **RANDOM**: This button performs random playback.
- 15 **REPEAT**: This button replays the track(or tracks). Pressing this button repeatedly cycles through the repeat modes.
- 16 **DISPLAY**: This button changes the displayed track information during playback. Pressing this button when the list screen is displayed toggles the screen to playback.
  - Bluetooth-enabled devices: Usable buttons are ▶, ◀◀, ◀, ||, ▶▶, ▶▶▶, and ■.

### Icons Displayed during Playback

Icons are displayed on the display during music file playback. The meaning of each icon is as follows:

📁: Folder

📀: Track

🎵: Play

⏸: Pause

⏩: Fast-forward

⏪: Fast-reverse

👤: Artist

📀: Album

🔁: Repeat One Track

📁🔁: Repeat within a folder

🔁: Repeat

🎵: Shuffle

## Using the Listening Modes

### Selecting Listening Mode

The listening modes allow you to select the best sound effect for your input source.

1. Press RCV on the remote controller.
  - Always press RCV first to change the remote controller to RECEIVER mode (the mode to operate this unit) since its mode may be changed to operate another component.

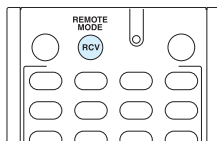

2. Press one of the following buttons depending on your choice from among the four listening modes.
  - Pressing a button changes the listening mode to that chosen. Set the listening mode of your choice by listening to the actual sound.

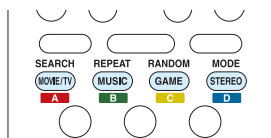

For details on the types and difference of listening modes, see "Contents of Listening Modes".

### ■ MOVIE/TV button

You can select a mode suitable for movies and TV programs.

- Selectable listening modes:
  - All Ch Stereo
  - Direct
  - Dolby D
  - Dolby D+
  - Dolby EX/Dolby D EX
  - Dolby TrueHD
  - DSD
  - DTS
  - DTS 96/24
  - DTS Express
  - DTS-HD HR
  - DTS-HD MSTR
  - ES Discrete
  - ES Matrix
  - Full Mono
  - Mono
  - Multichannel
  - Neo:6
  - Neo:6 Cinema
  - PLII Movie
  - PLIIx Movie/PLII Movie
  - PLIIz Height
  - T-D
  - TV Logic

### ■ MUSIC button

You can select a mode suitable for music.

- Selectable listening modes:
  - All Ch Stereo
  - Direct
  - Dolby D
  - Dolby D+
  - Dolby EX/Dolby D EX
  - Dolby TrueHD
  - DSD
  - DTS
  - DTS 96/24
  - DTS Express
  - DTS-HD HR
  - DTS-HD MSTR

- ES Discrete
- ES Matrix
- Full Mono
- Multichannel
- Neo:6
- Neo:6 Music
- Orchestra
- PLII Music
- PLIIx Music/PLII Music
- PLIIz Height
- Pure Audio
- Stereo
- Studio-Mix
- Unplugged

### ■ GAME button

You can select a mode suitable for games.

- Selectable listening modes:
  - All Ch Stereo
  - Direct
  - Dolby D
  - Dolby D+
  - Dolby EX/Dolby D EX
  - Dolby TrueHD
  - DSD
  - DTS
  - DTS 96/24
  - DTS Express
  - DTS-HD HR
  - DTS-HD MSTR
  - ES Discrete
  - ES Matrix
  - Full Mono
  - Neo:6
  - Game-Action
  - Game-Rock
  - Game-RPG
  - Game-Sports
  - Multichannel
  - PLII Game
  - PLIIx Game/PLII Game
  - PLIIz Height
  - T-D



## ■ STEREO button

You can select a listening mode for stereo and all channel stereo sources.

- Selectable listening modes:
  - All Ch Stereo
  - Stereo

## ■ PURE AUDIO button (on the main unit only) (European, Australian and Asian models)

The display and analog video circuit is cut off to switch the unit to PURE AUDIO mode (European, Australian and Asian models) and provide purer sound. Selecting this mode lights the PURE AUDIO indicator on the unit. Pressing the button again reselects the previous listening mode.

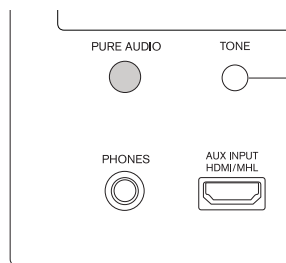

- Selecting Pure Audio for listening mode turns off the display and analog video circuitry, but the video signals input through HDMI input are output from HDMI output.

## Contents of Listening Modes

Selectable listening modes will differ depending on the number of input source channels and the actual speaker configuration. Listening modes available when headphones are connected are: Pure Audio (European, Australian and Asian models), Mono, Direct, and Stereo.

## Lists in alphabetic order (A-Z)

### ■ All Ch Stereo

Ideal for background music, this mode fills the entire listening area with stereo sound from the front, surround, and surround back speakers.

- Input source: MONO, STEREO, 5.1 ch, 7.1 ch
- Speaker configuration: 3.1 ch, 5.1 ch, 7.1 ch

### ■ Direct

In this mode, audio from the input source is output as-is. For example, if a 2 ch source from a music CD is input, the output will be stereo, or if Dolby Digital signal is input, the sound field will be controlled in accordance with the number of channels present.

- Input source: MONO, STEREO, 5.1 ch, 7.1 ch
- Speaker configuration: 2.1 ch, 3.1 ch, 5.1 ch, 7.1 ch

### ■ Dolby D (Dolby Digital)

This mode is for use with Dolby Digital sources. The audio from the input source is output as-is, without surround sound processing.

- Input source: 5.1 ch
- Speaker configuration: 3.1 ch, 5.1 ch, 7.1 ch
- This listening mode can be selected only if your Blu-ray Disc/DVD player is digitally connected to the unit or the player's output setting is bitstream.

### ■ Dolby D + (Dolby Digital Plus)

This mode is for use with Dolby Digital Plus sources. The audio from the input source is output as-is, without surround sound processing.

- Input source: 5.1 ch, 7.1 ch
- Speaker configuration: 3.1 ch, 5.1 ch, 7.1 ch
- This listening mode can be selected only if your Blu-ray Disc/DVD player is digitally connected to the unit or the player's output setting is bitstream.
- When playing back 5.1 ch sources from Blu-ray Discs, Dolby Digital is automatically applied.

### ■ Dolby EX/Dolby D EX

This mode expands any 5.1 ch music or movie source for 6.1/7.1 ch playback that can give an effect of surround

back speaker. It is suitable for the Dolby EX soundtrack containing the matrix-encoded surround back channel. Adding the surround back effect to 5.1 ch source will improve spatial representation by creating a moving sound effect of 360-degree surround sound or overhead sound and giving a realistic experience.

- Input source: 5.1 ch
- Speaker configuration: 7.1 ch surround back
- This listening mode can be selected only if your Blu-ray Disc/DVD player is digitally connected to the unit or the player's output setting is bitstream.

### ■ Dolby Pro Logic IIx/Dolby Pro Logic II

This mode expands any 2 ch source for 7.1-ch playback. It provides a very natural and seamless surround-sound experience, keeping the sound clear.

- In case of 5.1 ch without surround back speaker, the mode becomes Dolby Pro LogicII instead of Dolby Pro Logic IIx.
- **PLIIx Movie/PLII Movie:** Use this mode with any 2 ch movie (e.g., TV, DVD, VHS).
- **PLIIx Music/PLII Music:** Use this mode with any 2 ch music source (e.g., CD, radio, cassette, TV, DVD, VHS).
- **PLIIx Game/PLII Game:** Use this mode with any 2 ch game source.
- Input source: STEREO, 5.1 ch (PLIIx Movie and PLIIx Music only)
- Speaker configuration: 3.1 ch, 5.1 ch, 7.1 ch, 7.1 ch surround back (PLIIx Movie and PLIIx Music only)

### ■ Dolby TrueHD

This mode is for use with Dolby TrueHD sources. The audio from the input source is output as-is, without surround sound processing.

- Input source: 7.1 ch
- Speaker configuration: 3.1 ch, 5.1 ch, 7.1 ch
- This listening mode can be selected only if your Blu-ray Disc/DVD player is digitally connected to the unit or the player's output setting is bitstream.

### ■ DSD

This mode is for use with DSD sources. The audio from the input source is output as-is, without surround sound processing.

- Input source: 5.1 ch
- Speaker configuration: 3.1 ch, 5.1 ch, 7.1 ch
- This unit supports DSD signals input through HDMI IN. However, depending on the connected player, better sound is possible when output from the PCM output of the player. In that case, configure the player for PCM output.
- This listening mode can be selected only if your Blu-ray Disc/DVD player is digitally connected to the unit or the player's output setting is bitstream.

### ■ DTS

This mode is for use with DTS sources. The audio from the input source is output as-is, without surround sound processing.

- Input source: 5.1 ch
- Speaker configuration: 3.1 ch, 5.1 ch, 7.1 ch
- This listening mode can be selected only if your Blu-ray Disc/DVD player is digitally connected to the unit or the player's output setting is bitstream.

### ■ DTS 96/24

This mode is for use with DTS 96/24 sources. The audio from the input source is output as-is, without surround sound processing. With 96 kHz sampling rate and 24-bit resolution, it provides superior fidelity.

- Input source: 5.1 ch
- Speaker configuration: 3.1 ch, 5.1 ch, 7.1 ch
- Depending on the settings, this listening mode becomes DTS.
- This listening mode can be selected only if your Blu-ray Disc/DVD player is digitally connected to the unit or the player's output setting is bitstream.

### ■ DTS Express

This mode is for use with DTS Express sources. The audio from the input source is output as-is, without surround sound processing.

- Input source: 5.1 ch
- Speaker configuration: 3.1 ch, 5.1 ch, 7.1 ch
- This listening mode can be selected only if your Blu-ray Disc/DVD player is digitally connected to the unit or the player's output setting is bitstream.

### ■ DTS-HD HR (DTS-HD High Resolution Audio)

This mode is for use with DTS-HD High Resolution Audio sources. The audio from the input source is output as-is, without surround sound processing.

- Input source: 5.1 ch, 7.1 ch
- Speaker configuration: 3.1 ch, 5.1 ch, 7.1 ch
- This listening mode can be selected only if your Blu-ray Disc/DVD player is digitally connected to the unit or the player's output setting is bitstream.

### ■ DTS-HD MSTR (DTS-HD Master Audio)

This mode is for use with DTS-HD Master Audio sources. The audio from the input source is output as-is, without surround sound processing.

- Input source: 5.1 ch, 7.1 ch
- Speaker configuration: 3.1 ch, 5.1 ch, 7.1 ch
- This listening mode can be selected only if your Blu-ray Disc/DVD player is digitally connected to the unit or the player's output setting is bitstream.

### ■ DTS Neo:6

This mode expands any 2 ch source for 5.1 ch multichannel surround playback. It offers full-bandwidth on all channels, with great independence between the channels. There are two variants for this mode: one ideal for movies and another ideal for music.

- Neo:6 Cinema: Use this mode with any 2 ch movie (e.g., TV, DVD, VHS).
- Neo:6 Music: Use this mode with any 2 ch music source (e.g., CD, radio, cassette, TV, DVD, VHS).
- Neo:6: Use this mode to expand any 5.1 ch music source for 6.1 ch or 7.1 ch playback using Neo:6.
- Input source: STEREO (Neo:6 Cinema and Neo:6 Music only), 5.1 ch (Neo:6 only)  
Speaker configuration: 3.1 ch, 5.1 ch, 7.1 ch (Neo:6 Cinema and Neo:6 Music only), 7.1 ch surround back (Neo:6 only)

### ■ ES Discrete (DTS-ES Discrete)

This mode is for use with DTS-ES Discrete sources and enables 6.1 ch or 7.1 ch playback using surround back channel. Completely discrete seven channels will improve spatial imaging and enable 360-degree sound localization

producing a sound crossing between the surround channels.

- Input source: 6.1 ch
- Speaker configuration: 7.1 ch surround back
- This listening mode can be selected only if your Blu-ray Disc/DVD player is digitally connected to the unit or the player's output setting is bitstream.
- Use on the DVD with DTS ES logo, particularly on the software containing DTS-ES Matrix soundtrack.
- Playback becomes DTS if no surround back speaker is connected.

### ■ ES Matrix (DTS-ES Matrix)

This mode is for use with DTS-ES Matrix soundtrack and enables 6.1 ch or 7.1 ch playback using matrix-encoded back channel.

- Input source: 6.1 ch
- Speaker configuration: 7.1 ch surround back
- This listening mode can be selected only if your Blu-ray Disc/DVD player is digitally connected to the unit or the player's output setting is bitstream.
- Use on the CD, DVD or LD with DTS ES logo, particularly on the software containing DTS-ES Matrix soundtrack.
- Playback becomes DTS if no surround back speaker is connected.

### ■ Full Mono

In this mode, all speakers output the same sound in mono, so the sound you hear is the same regardless of where you are within the listening room.

- Input source: MONO, STEREO, 5.1 ch, 7.1 ch
- Speaker configuration: 3.1 ch, 5.1 ch, 7.1 ch

### ■ Game-Action

In this mode, sound localization is distinct with emphasis on bass.

- Input source: MONO, STEREO, 5.1 ch, 7.1 ch
- Speaker configuration: 5.1 ch, 7.1 ch

### ■ Game-Rock

In this mode, sound pressure is emphasized to heighten live feel.

- Input source: MONO, STEREO, 5.1 ch, 7.1 ch
- Speaker configuration: 5.1 ch, 7.1 ch

### ■ Game-RPG

In this mode, the sound has a dramatic feel with a similar atmosphere to Orchestra mode.

- Input source: MONO, STEREO, 5.1 ch, 7.1 ch
- Speaker configuration: 5.1 ch, 7.1 ch

### ■ Game-Sports

Suitable for audio source with much reverberation.

- Input source: MONO, STEREO, 5.1 ch, 7.1 ch
- Speaker configuration: 5.1 ch, 7.1 ch

### ■ Mono

Use this mode when watching an old movie with a mono soundtrack, or use it to separately reproduce soundtracks in two different languages recorded in the left and right channels of some movies. It is also suitable for DVDs or other sources containing multiplexed audio.

- Input source: MONO, STEREO, 5.1 ch, 7.1 ch
- Speaker configuration: 2.1 ch, 3.1 ch, 5.1 ch, 7.1 ch

### ■ Multichannel

This mode is for use with PCM multichannel sources. The audio from the input source is output as-is, without surround sound processing.

- Input source: 5.1 ch, 7.1 ch
- Speaker configuration: 3.1 ch, 5.1 ch, 7.1 ch

### ■ Orchestra

Suitable for classical or operatic music, This mode emphasizes the surround channels in order to widen the stereo image, and simulates the natural reverberation of a large hall.

- Input source: MONO, STEREO, 5.1 ch, 7.1 ch
- Speaker configuration: 5.1 ch, 7.1 ch

### ■ PLIIz Height (Dolby Pro Logic IIz Height)

This mode allows you to effectively use the existing programs when height speakers are connected. It is suitable for various kinds of sources including movie, music and especially games.

- Input source: STEREO, 5.1 ch, 7.1 ch
- Speaker configuration: 7.1 ch height

### ■ Pure Audio (European, Australian and Asian models)

This mode reproduces the original sound accurately. Since the audio from the input source is output without surround sound processing and the display and video circuitry are turned off, possible noise sources are minimized for a realistic audio reproduction.

- Input source: MONO, STEREO, 5.1 ch, 7.1 ch
- Speaker configuration: 2.1 ch, 3.1 ch, 5.1 ch, 7.1 ch
- This mode cannot be selected when Zone 2 is active. Activating Zone 2 when this mode is selected, automatically switches the listening mode to Direct.

### ■ Stereo

In this mode, sound is output from the front left and right speakers and subwoofer.

- Input source: MONO, STEREO, 5.1 ch, 7.1 ch
- Speaker configuration: 2.1 ch, 3.1 ch, 5.1 ch, 7.1 ch

### ■ Studio-Mix

Suitable for rock or pop music, Listening to music in this mode creates a lively sound field with a powerful acoustic image, like being at a club or rock concert.

- Input source: MONO, STEREO, 5.1 ch, 7.1 ch
- Speaker configuration: 5.1 ch, 7.1 ch

### ■ T-D (Theater-Dimensional)

In this mode, you can enjoy a virtual playback of multichannel surround sound even with only two or three speakers. This works by controlling how sounds reach the listener's left and right ears.

- Input source: MONO, STEREO, 5.1 ch, 7.1 ch
- Speaker configuration: 2.1 ch, 3.1 ch, 5.1 ch, 7.1 ch
- Good results may not be possible if there is too much reverb, so we recommend that you use this mode in an environment with little or no natural reverb.

### ■ TV Logic

Suitable for TV shows produced in a TV studio, This mode enhances the surround effects to the entire sound to give

clarity to voices and create a realistic acoustic image.

- Input source: MONO, STEREO, 5.1 ch, 7.1 ch
- Speaker configuration: 5.1 ch, 7.1 ch

### ■ Unplugged

Suitable for acoustic instruments, vocals and jazz, This mode emphasizes the front stereo image, giving the impression of being right in front of the stage.

- Input source: MONO, STEREO, 5.1 ch, 7.1 ch
- Speaker configuration: 5.1 ch, 7.1 ch

### Checking the Input Format

You can check the audio format of the input signals. While audio from the player is being input, press DISPLAY on the remote controller several times to switch the information shown on the main unit display. If "Dolby D 5.1" is displayed in Signal format, the Dolby Digital 5.1 ch signals are being input.

---

Dolby D 5.1<sup>\*</sup>

---

## Advanced Settings

### How to Set

The unit allows you to configure advanced settings, such as to remap the input and input selector, or configure various speaker settings in order to provide even better experience. Make the settings in "Setup" of the Home menu.

● **Operation:** You can set up by viewing the guidance displayed on the TV screen. To display the guidance, you need to make HDMI connection between the unit and TV. Select the item with the cursor buttons of the remote controller and press ENTER to confirm your selection. To return to the previous screen, press RETURN. To return to the Home menu, press HOME.

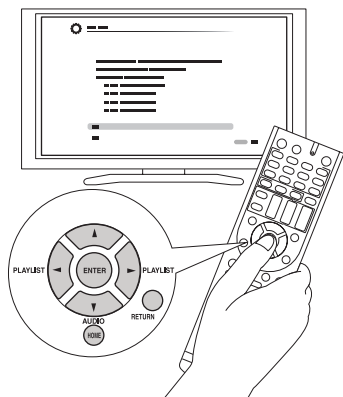

### ■ Operation

1. Press RCV on the remote controller.
  - Always press RCV first to change the remote controller to RECEIVER mode (the mode to operate this unit) since its mode may be changed to operate another component.

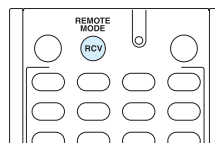

2. Press HOME to display the Home menu.

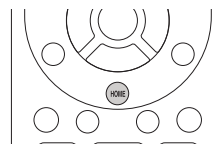

3. With the ◀▶ cursors, select "Setup", and then press ENTER.

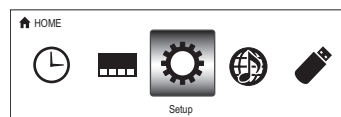

4. Press ▲▼ to select the desired menu, and then press ENTER.

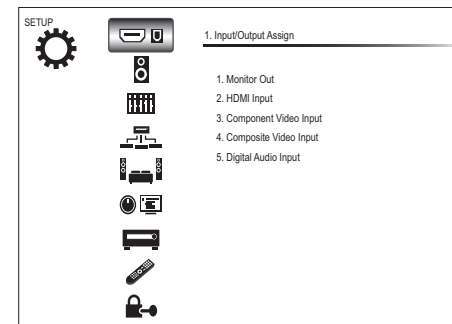

5. With the ▲▼/◀▶ cursors, select the desired item to configure the settings.
  - When "ENTER" is displayed on the setting item, press ENTER.

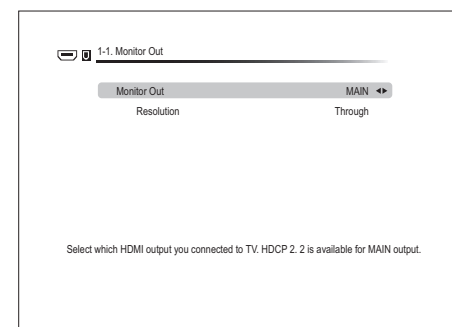

**To save changes and finish the setting:** Press HOME to exit.

## 1.Input/Output Assign

### Monitor Out

The video input signals input to the unit will be converted when they are output from the HDMI OUT jack to the TV so that their resolution can match that of the TV used.

| Setting item | Default Value | Setting Details   |
|--------------|---------------|---|
| Monitor Out  | MAIN          | <p>Select the HDMI jack to be connected with the TV.</p> <p>"MAIN": When connecting the TV to the HDMI OUT MAIN jack</p> <p>"SUB": When connecting the TV to the HDMI OUT SUB jack</p> <ul style="list-style-type: none"> <li>The resolution of the input signal does not change when output through HDMI OUT SUB jack.</li> </ul> <p>"MAIN+SUB": When connecting to both the MAIN and SUB jacks</p> <ul style="list-style-type: none"> <li>Video signals input to the composite video input jack or the COMPONENT VIDEO input jacks will be upconverted to HDMI signals and then output from the HDMI output jack.</li> <li>If "MAIN+SUB" is selected <ul style="list-style-type: none"> <li>Only "Through" or "Auto" can be selected in "Resolution".</li> <li>The resolution of the input signal does not change when output through HDMI OUT SUB jack.</li> </ul> </li> <li>HDCP2.2 protected video from HDMI OUT SUB will not be displayed.</li> </ul> |

| Setting item | Default Value | Setting Details   |
|--------------|---------------|---|
| Resolution   | Through       | <p>Specify the output resolution of the HDMI OUT jacks. The image resolution of the unit will be converted so that it can match the resolution supported by the TV used.</p> <p>"Through": The output resolution will be the same as that of the input signals.</p> <p>"Auto": The resolution will automatically be converted according to the resolution supported by the TV.</p> <p>"480p (480p/576p)", "720p", "1680×720p", "1080i", "1080p", "2560×1080p": Select the desired resolution.</p> <p>"4K": About four times as high resolution as 1080p (3840×2160 or 4096×2160 pixels depending on the resolution supported by the connected TV)</p> <ul style="list-style-type: none"> <li>If "1080p" is selected, 1080p/24 input signals will be output with an unchanged resolution.</li> <li>If the selected resolution is not supported by the monitor, the video is displayed in the same resolution as the input signal.</li> <li>If "4K" is selected, video signals may not be output to some types of TV. For details, see "Regarding the Video Resolution" in "Troubleshooting".</li> <li>If "Monitor Out" is set to "SUB", this setting will be set to "Through".</li> <li>Press ENTER if you output signals from the HDMI OUT MAIN jack and check the video on the TV while making this setting. Press RETURN if no video is displayed. (except when "NET", "USB" or "BLUETOOTH" is selected)</li> </ul> |

## HDMI Input

It is possible to change assignment of input selector buttons and the HDMI IN jacks.

| Setting item | Default Value       | Setting Details   |
|--------------|---------------------|---|
| BD/DVD       | HDMI 1              | "HDMI 1" to "HDMI 6": Desired HDMI IN jack can be assigned to BD/DVD button. If you do not assign a jack, select "----". To select an HDMI IN jack already assigned to another input selector, change its setting to "----" first.  |
| CBL/SAT      | HDMI 2              | "HDMI 1" to "HDMI 6": Desired HDMI IN jack can be assigned to CBL/SAT button. If you do not assign a jack, select "----". To select an HDMI IN jack already assigned to another input selector, change its setting to "----" first. |
| STB/DVR      | HDMI 3<br>(HDCP2.2) | "HDMI 1" to "HDMI 6": Desired HDMI IN jack can be assigned to STB/DVR button. If you do not assign a jack, select "----". To select an HDMI IN jack already assigned to another input selector, change its setting to "----" first. |
| GAME         | HDMI 4              | "HDMI 1" to "HDMI 6": Desired HDMI IN jack can be assigned to GAME button. If you do not assign a jack, select "----". To select an HDMI IN jack already assigned to another input selector, change its setting to "----" first.    |
| PC           | HDMI 5              | "HDMI 1" to "HDMI 6": Desired HDMI IN jack can be assigned to PC button. If you do not assign a jack, select "----". To select an HDMI IN jack already assigned to another input selector, change its setting to "----" first.      |
| AUX          | FRONT/MHL           | The setting cannot be changed.  |
| TV/CD        | ----                | "HDMI 1" to "HDMI 6": Desired HDMI IN jack can be assigned to TV/CD button. If you do not assign a jack, select "----". To select an HDMI IN jack already assigned to another input selector, change its setting to "----" first.   |
| PHONO        | ----                | "HDMI 1" to "HDMI 6": Desired HDMI IN jack can be assigned to PHONO button. If you do not assign a jack, select "----". To select an HDMI IN jack already assigned to another input selector, change its setting to "----" first.   |

## Component Video Input

CBL/SAT button is assigned to COMPONENT VIDEO IN jack as factory default setting. This assignment can be changed if necessary. If you do not assign a jack, select "----".

| Setting item | Default Value | Setting Details   |
|--------------|---------------|---|
| BD/DVD       | ----          | "COMPONENT": COMPONENT VIDEO IN jack is assigned to BD/DVD button.  |
| CBL/SAT      | COMPONENT     | "COMPONENT": COMPONENT VIDEO IN jack is assigned to CBL/SAT button. |
| STB/DVR      | ----          | "COMPONENT": COMPONENT VIDEO IN jack is assigned to STB/DVR button. |
| GAME         | ----          | "COMPONENT": COMPONENT VIDEO IN jack is assigned to GAME button.    |
| PC           | ----          | "COMPONENT": COMPONENT VIDEO IN jack is assigned to PC button.      |
| AUX          | ----          | The setting cannot be changed.                                      |
| TV/CD        | ----          | "COMPONENT": COMPONENT VIDEO IN jack is assigned to TV/CD button.   |
| PHONO        | ----          | "COMPONENT": COMPONENT VIDEO IN jack is assigned to PHONO button.   |

- When you convert video signals input to the COMPONENT VIDEO IN jacks and output them from the HDMI OUT jack, set the output resolution of the player to 480i. If the input has 480p or higher resolution, an error message will appear.
- When "Monitor Out" is set to "SUB", the 480i/576i component signals only will be output with an unchanged resolution. Video will not be displayed if the TV does not support the resolution.
- When "Monitor Out" is set to "MAIN" or "MAIN+SUB" and "Resolution" is set to "Through", the 480i/576i component signals will be output with their resolution unchanged. So, TV sets not supporting these resolutions will not be able to display video.

## Composite Video Input

It is possible to change assignment of input selector buttons and the COMPOSITE VIDEO IN V1 to 3 jacks.

| Setting item | Default Value | Setting Details   |
|--------------|---------------|---|
| BD/DVD       | -----         | "VIDEO 1" to "VIDEO 3": Desired COMPOSITE VIDEO IN jack can be assigned to BD/DVD button. If you do not assign a jack, select "-----".  |
| CBL/SAT      | VIDEO 1       | "VIDEO 1" to "VIDEO 3": Desired COMPOSITE VIDEO IN jack can be assigned to CBL/SAT button. If you do not assign a jack, select "-----". |
| STB/DVR      | VIDEO 2       | "VIDEO 1" to "VIDEO 3": Desired COMPOSITE VIDEO IN jack can be assigned to STB/DVR button. If you do not assign a jack, select "-----". |
| GAME         | VIDEO 3       | "VIDEO 1" to "VIDEO 3": Desired COMPOSITE VIDEO IN jack can be assigned to GAME button. If you do not assign a jack, select "-----".    |
| PC           | -----         | "VIDEO 1" to "VIDEO 3": Desired COMPOSITE VIDEO IN jack can be assigned to PC button. If you do not assign a jack, select "-----".      |
| AUX          | -----         | The setting cannot be changed.  |
| TV/CD        | -----         | "VIDEO 1" to "VIDEO 3": Desired COMPOSITE VIDEO IN jack can be assigned to TV/CD button. If you do not assign a jack, select "-----".   |
| PHONO        | -----         | "VIDEO 1" to "VIDEO 3": Desired COMPOSITE VIDEO IN jack can be assigned to PHONO button. If you do not assign a jack, select "-----".   |

- When "Monitor Out" is set to "SUB", the 480i/576i composite signals only will be output with an unchanged resolution. Video will not be displayed if the TV does not support the resolution.
- When "Monitor Out" is set to "MAIN" or "MAIN+SUB" and "Resolution" is set to "Through", the 480i/576i composite signals will be output with their resolution unchanged. So, TV sets not supporting these resolutions will not be able to display video.

## Digital Audio Input

It is possible to change assignment of input selector buttons and the DIGITAL IN COAXIAL 1 to 2/OPTICAL jacks.

| Setting item | Default Value | Setting Details  |
|--------------|---------------|--|
| BD/DVD       | COAXIAL 1     | "COAXIAL 1", "COAXIAL 2", "OPTICAL": Desired DIGITAL IN jack can be assigned to BD/DVD button. If you do not assign a jack, select "-----".  |
| CBL/SAT      | COAXIAL 2     | "COAXIAL 1", "COAXIAL 2", "OPTICAL": Desired DIGITAL IN jack can be assigned to CBL/SAT button. If you do not assign a jack, select "-----". |
| STB/DVR      | -----         | "COAXIAL 1", "COAXIAL 2", "OPTICAL": Desired DIGITAL IN jack can be assigned to STB/DVR button. If you do not assign a jack, select "-----". |
| GAME         | -----         | "COAXIAL 1", "COAXIAL 2", "OPTICAL": Desired DIGITAL IN jack can be assigned to GAME button. If you do not assign a jack, select "-----".    |
| PC           | -----         | "COAXIAL 1", "COAXIAL 2", "OPTICAL": Desired DIGITAL IN jack can be assigned to PC button. If you do not assign a jack, select "-----".      |
| AUX          | -----         | The setting cannot be changed.   |
| TV/CD        | OPTICAL       | "COAXIAL 1", "COAXIAL 2", "OPTICAL": Desired DIGITAL IN jack can be assigned to TV/CD button. If you do not assign a jack, select "-----".   |
| PHONO        | -----         | "COAXIAL 1", "COAXIAL 2", "OPTICAL": Desired DIGITAL IN jack can be assigned to PHONO button. If you do not assign a jack, select "-----".   |

- Supported sampling rates for PCM signals (stereo, mono) from a digital input are 32/44.1/48/88.2/96 kHz/16, 20, 24 bit.

## 2. Speaker Setup

Allows you to change the speaker configuration such as existence of subwoofer, crossover frequency, and so on. Settings are automatically configured if you use the Automatic Speaker Setup.

Furthermore, you will not be able to select this setting if you have a pair of headphones connected or you are listening through your TV speakers.

### Speaker Settings

Change the impedance of the connected speakers, the type of front speaker connection, and other speaker settings.

| Setting item  | Default Value | Setting Details  |
|---|---------------|--|
| Speaker Impedance (European, Australian and Asian models) | 6ohms         | Set the impedance of the connected speakers.<br>"4ohms": When any of the connected speakers have 4 $\Omega$ or more to less than 6 $\Omega$ impedance<br>"6ohms": When the connected speakers all have 6 $\Omega$ or more impedance  |
| Front Speakers Type                                       | Normal        | Select the type of front speaker connection.<br>"Normal": When front speakers are connected in a normal manner<br>"Bi-Amp": When front speakers are bi-amp connected   |
| Powered Zone 2  | No            | Set presence of speaker terminal connection of Zone 2<br>"Yes": When speakers are connected to ZONE2 speaker terminals<br>"No": When speakers are not connected to ZONE2 speaker terminals<br><ul style="list-style-type: none"> <li>If "Front Speakers Type" is set to "Bi-Amp", this setting will be set to "No".</li> </ul> |

- For impedance, check the indications on the back of the speakers or their instruction manual.

## Speaker Configuration

Allows you to change the speaker configuration such as presence or not of each speaker, crossover frequency, and so on. Settings are automatically configured if you use the Automatic Speaker Setup. Audio will not be output while you are making this setting.

| Setting item | Default Value | Setting Details   |
|--------------|---------------|---|
| Subwoofer    | Yes           | Set whether a subwoofer is connected or not.<br>"Yes": When subwoofer is connected<br>"No": When subwoofer is not connected   |
| Front        | 100Hz         | Select the frequency to start outputting bass frequencies (crossover frequency) for each channel from "40Hz" to "200Hz".<br>"Full Band": Full band will be output.<br>"None": When no compatible speaker is connected<br><ul style="list-style-type: none"> <li>"Front" will be fixed to "Full Band" if "Subwoofer" is set to "No", and the bass frequencies of the other channels will be output from the front speakers. To make the settings, refer to the instruction manual of the speakers used.</li> </ul> |
| Center       | 100Hz         | Select the frequency to start outputting bass frequencies (crossover frequency) for each channel from "40Hz" to "200Hz".<br>"Full Band": Full band will be output.<br>"None": When no compatible speaker is connected<br><ul style="list-style-type: none"> <li>This setting cannot be set to "Full Band" unless "Front" is set to "Full Band".</li> </ul>  |
| Surround     | 100Hz         | Select the frequency to start outputting bass frequencies (crossover frequency) for each channel from "40Hz" to "200Hz".<br>"Full Band": Full band will be output.<br>"None": When no compatible speaker is connected<br><ul style="list-style-type: none"> <li>This setting cannot be set to "Full Band" unless "Front" is set to "Full Band".</li> </ul>  |



| Setting item | Default Value | Setting Details  |
|--------------|---------------|--|
| Back         | 100Hz         | <p>Select the frequency to start outputting bass frequencies (crossover frequency) for each channel from "40Hz" to "200Hz".</p> <p>"Full Band": Full band will be output.</p> <p>"None": When no compatible speaker is connected</p> <ul style="list-style-type: none"> <li>In the following cases, this setting will be set to "None": <ul style="list-style-type: none"> <li>"Surround" is set to "None".</li> <li>"Front Speakers Type" is set to "Bi-Amp".</li> <li>"Powered Zone 2" is set to "Yes" and also Zone2 is set to on.</li> </ul> </li> <li>This setting cannot be set to "Full Band" unless "Surround" is set to "Full Band".</li> </ul> |
| Height       | None          | <p>Select the frequency to start outputting bass frequencies (crossover frequency) for each channel from "40Hz" to "200Hz".</p> <p>"Full Band": Full band will be output.</p> <p>"None": When no compatible speaker is connected</p> <ul style="list-style-type: none"> <li>In the following cases, this setting will be set to "None": <ul style="list-style-type: none"> <li>"Surround" is set to "None".</li> <li>"Front Speakers Type" is set to "Bi-Amp".</li> <li>"Powered Zone 2" is set to "Yes" and also Zone2 is set to on.</li> </ul> </li> <li>This setting cannot be set to "Full Band" unless "Front" is set to "Full Band".</li> </ul>    |
| Back ch      | 2ch           | <p>Select the number of channels of the connected surround back speaker.</p> <p>"1ch": When one speaker is connected (Connect to the BACK or HEIGHT L terminal)</p> <p>"2ch": When two speakers are connected</p> <ul style="list-style-type: none"> <li>The setting cannot be changed if "Surround" or "Back" is set to "None".</li> </ul>  |
| LPF of LFE   | 120Hz         | <p>Set the low-pass filter for LFE (low-frequency effect) signals in order to pass lower frequency signals than the set value and thus cancel unwanted noises. The low-pass filter will be effective only on sources with LFE channel. Set a frequency from "80Hz", "90Hz", "100Hz" and "120Hz".</p> <p>"Off": Do not use this function</p>  |

| Setting item | Default Value | Setting Details   |
|--------------|---------------|---|
| Double Bass  | ----          | <p>Boost bass output by feeding bass sounds from the front left and right, and center speakers to the subwoofer.</p> <p>"On": Bass output will be boosted.</p> <p>"Off": Bass output will not be boosted.</p> <ul style="list-style-type: none"> <li>The setting will not automatically be configured even if you performed the automatic speaker setup.</li> <li>If "Subwoofer" is set to "No" or if "Front" is set to other than "Full Band", the setting will be fixed to "----".</li> </ul> |

## Speaker Distance

Set the distance from each speaker to the listening position. Settings are automatically configured if you use the automatic speaker setup.

| Setting item   | Default Value  | Setting Details  |
|----------------|----------------|--|
| Unit           | feet/meters    | Specify the unit of distance for configuring settings.<br>"feet": When setting in feet (0.1 ft to 30.0 ft, in increments of 0.1 ft)<br>"meters": When setting in meters (0.03 m to 9.00 m, in increments of 0.03 m)      |
| Front Left     | 12.0 ft/3.60 m | Specify the distance between each speaker and the listening position.  |
| Center         | 12.0 ft/3.60 m | Specify the distance between each speaker and the listening position.  |
| Front Right    | 12.0 ft/3.60 m | Specify the distance between each speaker and the listening position.  |
| Surround Right | 7.0 ft/2.10 m  | Specify the distance between each speaker and the listening position.  |
| Back Right     | 7.0 ft/2.10 m  | Specify the distance between each speaker and the listening position.<br><ul style="list-style-type: none"> <li>This setting cannot be changed when "Powered Zone 2" is set to "Yes" and Zone 2 is turned on.</li> </ul> |
| Back Left      | 7.0 ft/2.10 m  | Specify the distance between each speaker and the listening position.<br><ul style="list-style-type: none"> <li>This setting cannot be changed when "Powered Zone 2" is set to "Yes" and Zone 2 is turned on.</li> </ul> |
| Surround Left  | 7.0 ft/2.10 m  | Specify the distance between each speaker and the listening position.  |
| Subwoofer      | 12.0 ft/3.60 m | Specify the distance between each speaker and the listening position.  |
| Height Left    | 9.0 ft/2.70 m  | Specify the distance between each speaker and the listening position.<br><ul style="list-style-type: none"> <li>This setting cannot be changed when "Powered Zone 2" is set to "Yes" and Zone 2 is turned on.</li> </ul> |

| Setting item | Default Value | Setting Details  |
|--------------|---------------|--|
| Height Right | 9.0 ft/2.70 m | Specify the distance between each speaker and the listening position.<br><ul style="list-style-type: none"> <li>This setting cannot be changed when "Powered Zone 2" is set to "Yes" and Zone 2 is turned on.</li> </ul> |

- When the speaker is set to "No" or "None" in "Speaker Configuration", the settings for "Speaker Distance" cannot be changed:
- Default values vary depending on the regions.

## Level Calibration

Adjust the level of each speaker with the built-in test tone. Settings are automatically configured if you use the Automatic Speaker Setup.

| Setting item   | Default Value | Setting Details   |
|----------------|---------------|---|
| Front Left     | 0 dB          | Select a value between "-12 dB" to "+12 dB". A test tone will be output each time you change the value. Select the desired level. |
| Center         | 0 dB          | Select a value between "-12 dB" to "+12 dB". A test tone will be output each time you change the value. Select the desired level. |
| Front Right    | 0 dB          | Select a value between "-12 dB" to "+12 dB". A test tone will be output each time you change the value. Select the desired level. |
| Surround Right | 0 dB          | Select a value between "-12 dB" to "+12 dB". A test tone will be output each time you change the value. Select the desired level. |
| Back Right     | 0 dB          | Select a value between "-12 dB" to "+12 dB". A test tone will be output each time you change the value. Select the desired level. |
| Back Left      | 0 dB          | Select a value between "-12 dB" to "+12 dB". A test tone will be output each time you change the value. Select the desired level. |
| Surround Left  | 0 dB          | Select a value between "-12 dB" to "+12 dB". A test tone will be output each time you change the value. Select the desired level. |
| Subwoofer      | 0 dB          | Select a value between "-15 dB" to "+12 dB". A test tone will be output each time you change the value. Select the desired level. |
| Height Left    | 0 dB          | Select a value between "-12 dB" to "+12 dB". A test tone will be output each time you change the value. Select the desired level. |
| Height Right   | 0 dB          | Select a value between "-12 dB" to "+12 dB". A test tone will be output each time you change the value. Select the desired level. |

- In the following cases, the settings for "Level Calibration" cannot be changed:
  - The speaker is set to "No" or "None" in "Speaker Configuration".
  - Mute (MUTING) is set.

## 3.Audio Adjust

Configure various settings related to sound, such as settings for listening to multiplex audio or multilingual TV broadcasts and sound field settings for listening modes.

### Multiplex/Mono

| Setting item            | Default Value | Setting Details   |
|-------------------------|---------------|---|
| Multiplex Input Channel | Main          | Set the audio channel or language to be output when playing multiplex audio or multilingual TV broadcasts etc.<br>"Main": Main channel only<br>"Sub": Sub channel only<br>"Main/Sub": Main and sub channels will be output at the same time. <ul style="list-style-type: none"> <li>• If multiplex audio is being played, "1+1" will be displayed when DISPLAY is pressed.</li> </ul> |
| Mono Input Channel      | Left+Right    | Set the input channel to use for playing any 2 ch digital source such as Dolby Digital, or 2-ch analog/PCM source in the Mono listening mode.<br>"Left": Left channel only<br>"Right": Right channel only<br>"Left + Right": Left and right channels  |

### Dolby

Make the settings for Dolby listening mode.

| Setting item                     | Default Value | Setting Details  |
|----------------------------------|---------------|--|
| PLIIx Music (2ch Input) Panorama | Off           | Adjust the sound field setting for playing any 2 ch digital source such as Dolby Digital or 2 ch analog/PCM source in the Dolby PrologicII Music listening mode. Select the width of sound field.<br>"On": Width of sound field will be increased.<br>"Off": Default value |

| Setting item                         | Default Value | Setting Details   |
|--------------------------------------|---------------|---|
| PLIIx Music (2ch Input) Dimension    | 0             | Adjust the sound field setting for playing any 2 ch digital source such as Dolby Digital or 2 ch analog/PCM source in the Dolby PrologicII Music listening mode. Select the depth of sound field.<br>"-3" to "+3": The sound field shifts forward as the set value becomes smaller than "0" and backward if the set value become larger than "0".   |
| PLIIx Music (2ch Input) Center Width | 3             | Configure the setting to use for playing any 2 ch digital source such as Dolby Digital, or 2-ch analog/PCM source in the Dolby PrologicII Music listening mode. Adjust the width of the sound from the center speaker).<br>"0" to "7": The smaller the setting value is, the more concentrated in the center speaker is the sound, while the larger the setting value is, the more distributed to the front left and right speakers is the sound of the center speaker.   |
| PLIIz Height Gain                    | Mid           | Adjust the output level of the height speakers in the Dolby Pro Logic IIz Height listening mode. The output of the height speakers will be enhanced in the order of "Low", "Mid" (Middle), "High": "Low", "Mid" and "High".<br><ul style="list-style-type: none"> <li>In the following cases, the setting cannot be changed: <ul style="list-style-type: none"> <li>"Height" is set to "None" in "Speaker Configuration".</li> <li>"Powered Zone 2" is set to "Yes" and also Zone2 is set to on.</li> </ul> </li> </ul> |
| Dolby EX                             | Manual        | The Dolby Digital EX listening mode will automatically be selected when Dolby EX signals are input.<br>"Auto": Use this function<br>"Manual": Select the desired listening mode<br><ul style="list-style-type: none"> <li>In the following cases, the setting cannot be changed: <ul style="list-style-type: none"> <li>"Back" is set to "None" in "Speaker Configuration".</li> <li>"Powered Zone 2" is set to "Yes" and also Zone2 is set to on.</li> </ul> </li> </ul>   |

| Setting item        | Default Value | Setting Details   |
|---------------------|---------------|---|
| Loudness Management | On            | Enable the Late Night function that allows you to enjoy surround sound of Dolby TrueHD playback even in low volume.<br>"On": Use this function<br>"Off": Do not use this function |

- Depending on the setting of "Back" in "Speaker Configuration", the display will be changed. "PLIIx" will be displayed as "PLIIx/PLII"

## DTS

Make the settings for DTS Neo:6 Music listening mode.

| Setting item             | Default Value | Setting Details  |
|--------------------------|---------------|--|
| Neo:6 Music Center Image | 2             | Adjust the width of the sound field of the front channel when playing in the DTS Neo:6 Music listening mode.<br>"0" to "5": Selecting a smaller value brings the sound field of the front channel to the center while selecting a larger value spreads the sound field of the front channel to left and right. |

## Theater-Dimensional

Make the settings for Theater-Dimensional mode.

| Setting item    | Default Value | Setting Details  |
|-----------------|---------------|--|
| Listening Angle | Wide          | Set the angle of the front left and right speakers relative to the listening position when playing in the Theater-Dimensional listening mode.<br>"Narrow": Less than 30°<br>"Wide": Greater than 30° |

- Values recommended for "Listening Angle" are: 20° when "Narrow" is selected and 40° when "Wide" is selected.

## 4.Source Setup

Adjust the volume level difference among the multiple devices connected to this unit, rename an input selector, or adjust the image quality. The setting can be separately set to each input selector button. When you select a desired input to check the video or audio, start playback of the connected device.

### AccuEQ Room Calibration

| Setting item            | Default Value | Setting Details  |
|-------------------------|---------------|--|
| AccuEQ Room Calibration | Off           | Enable/disable the sound field set in automatic speaker setup<br>"On": Enable this function<br>"Off": Disable this function <ul style="list-style-type: none"> <li>• In the following cases, the setting cannot be changed:               <ul style="list-style-type: none"> <li>– Automatic speaker setup is not performed.</li> <li>– Headphones are connected.</li> </ul> </li> </ul> |

### IntelliVolume

| Setting item  | Default Value | Setting Details   |
|---------------|---------------|---|
| IntelliVolume | 0 dB          | Adjust the volume level difference between the devices connected to the unit. Select a value between "-12 dB" to "+12 dB". Set a negative value if the volume of the target device is larger than the others and a positive value if smaller. <ul style="list-style-type: none"> <li>• This function is not effective in Zone 2.</li> </ul> |

## Name Edit

Set an easy name to each input. The set name will be shown on the main unit display.

| Setting item | Default Value | Setting Details  |
|--------------|---------------|--|
| Name         | Input name    | <ol style="list-style-type: none"> <li>Select a character or symbol with the cursors and press ENTER. Repeat it to input 10 or less characters.           <ul style="list-style-type: none"> <li>"Shift": Switches between upper and lower cases. (Pressing +10 on the remote controller also toggles between upper and lower cases.)</li> <li>"←" "→": Moves the cursor to the arrow direction.</li> <li>"Back Space": Removes a character on the left of the cursor.</li> <li>"Space": Puts a space.               <ul style="list-style-type: none"> <li>Pressing CLR on the remote controller will remove all the input characters.</li> </ul> </li> </ul> </li> <li>After inputting, select "OK" with the cursors and press ENTER. The input name will be saved.</li> </ol> |

- To name a preset radio station, press TUNER on the remote controller, select AM/FM and select the preset number.
- It cannot be set if the input is "NET", "USB" or "BLUETOOTH".

## Picture Adjust

Adjust the image quality. (Possible only when the video player is connected to the HDMI OUT MAIN jack) If you adjust it by checking the video, press ENTER. Press RETURN to return the screen to the previous status.

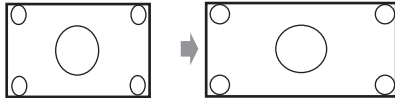
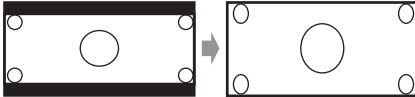
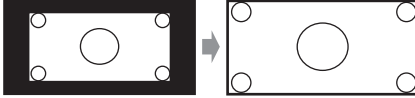
| Setting item | Default Value | Setting Details  |
|--------------|---------------|--|
| Wide Mode    | Auto          | <p>Set the aspect ratio.</p> <p>"Auto": The aspect ratio will automatically be set according to the input signals and the monitor output setting.</p> <p>"4:3":</p>  <p>"Full":</p>  <p>"Zoom":</p>  <p>"Wide Zoom":</p>  <ul style="list-style-type: none"> <li>When a 3D or 4K video source is input, this setting is set to "Full". Furthermore, for some resolutions, this setting may be disabled and set to "Full".</li> </ul> |

| Setting item     | Default Value | Setting Details   |
|------------------|---------------|---|
| Picture Mode     | Custom        | An appropriate image quality setting for cinema or game will be selected. You can also adjust each item to obtain your favorite image quality.<br>"Custom": The items from "Game Mode" to "Color Temperature" below can be adjusted as desired.<br>"Cinema": When the video source is cinema<br>"Game": When the video source is game<br>"Standard": The resolution will be changed but the image quality will not be adjusted.<br>"Bypass": Both the resolution and image quality will not be adjusted. <ul style="list-style-type: none"> <li>If you select "Bypass", the on-screen display function will be disabled.</li> </ul> |
| Game Mode        | Off           | Change to the setting suitable for game. Also correct the delay of video signals of the game console if any.<br>"On": Use this function<br>"Off": Do not use this function <ul style="list-style-type: none"> <li>If you select "On", the delay will be corrected but the image quality will be lower.</li> <li>The setting will be fixed to "Off" if "Resolution" is set to "4K".</li> </ul>   |
| Film Mode        | Auto          | Change to the setting suitable for film.<br>"Auto": Image processing suitable for film will be executed.<br>"Video": "Film Mode" will not be applied and the input signals will be processed as video source.   |
| Edge Enhancement | Off           | Adjust the sharpness of the outline of image. Select from "Off", "Low", "Mid" (Middle), and "High". <ul style="list-style-type: none"> <li>The setting will be fixed to "Off" if "Game Mode" is set to "On".</li> <li>When the horizontal resolution of the output video is 2,000 TV lines or more, this setting is set to "Off".</li> </ul>  |
| Noise Reduction  | Off           | Reduces the noise of the screen. Select from "Off", "Low", "Mid" (Middle), and "High". <ul style="list-style-type: none"> <li>The setting will be fixed to "Off" if "Game Mode" is set to "On".</li> </ul>  |

| Setting item      | Default Value | Setting Details   |
|-------------------|---------------|---|
| Brightness        | 0             | Adjust brightness of the screen. Select a value between "-50" to "+50".       |
| Contrast          | 0             | Adjust contrast of the screen. Select a value between "-50" to "+50".         |
| Hue               | 0             | Correct hue of the screen. Select a value between "-50" to "+50".             |
| Saturation        | 0             | Adjust saturation of the screen. Select a value between "-50" to "+50".       |
| Color Temperature | Normal        | Set color temperature of the screen. Select from "Warm", "Normal" and "Cool". |

- In the following cases, the settings for "Picture Adjust" cannot be changed:
  - "NET", "USB" or "BLUETOOTH" is selected.
  - "Monitor Out" is set to "SUB".
- Press CLR on the remote controller if you return all the settings from "Game Mode" through "Color Temperature" to their default value.

## Audio Selector

Make the audio input setting. The setting can be separately set to each input selector button. Select the input selector to configure.

| Setting item   | Default Value | Setting Details  |
|----------------|---------------|--|
| Audio Selector | —             | <p>Allows you to select prior input source.</p> <p>ARC: When giving priority to input signal from ARC compatible TV.</p> <ul style="list-style-type: none"> <li>The setting can be selected only when "Audio Return Channel" is set to "Auto" and also the "TV/CD" input is selected.</li> </ul> <p>HDMI: When giving priority to input signal from HDMI jacks</p> <ul style="list-style-type: none"> <li>The setting can be selected only when the input is assigned to the HDMI IN jack in the "HDMI Input" setting.</li> </ul> <p>"COAXIAL (Coaxial input)": When giving priority to input signal from DIGITAL IN COAXIAL jacks.</p> <ul style="list-style-type: none"> <li>The setting can be selected only when the input is assigned to the COAXIAL jack in the "Digital Audio Input" setting.</li> </ul> <p>"OPTICAL (Optical input)": When giving priority to input signal from DIGITAL IN OPTICAL jacks.</p> <ul style="list-style-type: none"> <li>The setting can be selected only when the input is assigned to the OPTICAL jack in the "Digital Audio Input" setting.</li> </ul> <p>"Analog": To always output analog audio independently of the input signal</p> |
| Fixed Mode     | Off           | <p>Specify an input signal when "HDMI", "COAXIAL (Coaxial input)", or "OPTICAL (Optical input)" is selected for "Audio Selector". Set this item if noise is produced, or truncation occurs at the beginning of a track that follows a gap when playing PCM or DTS sources.</p> <p>"Off": To play an analog signal when there is no digital signal.</p> <p>"PCM": To fix the input source to PCM.</p> <p>"DTS": To fix the input source to DTS (except for DTS-HD)</p> <ul style="list-style-type: none"> <li>Changing "Audio Selector" changes the setting to "Off".</li> </ul>  |

- The setting cannot be changed when "TUNER", "NET", "USB" or "BLUETOOTH" is selected.

## 5.Listening Mode Preset

You can preset your favorite listening mode to each input. (For example, you can always apply straight decode to the Dolby TrueHD source of Blu-ray Disc to play it in unchanged sound field.) Select the input, signal type and listening mode. Although it is possible to select the listening mode during playback, the selected mode will be reset when the unit enters standby mode.

| Setting item                    | Default Value | Setting Details   |
|---------------------------------|---------------|---|
| Analog/PCM                      | Last Valid    | Set the listening mode for playing PCM signals of CD and analog signals of record and cassette tape.  |
| Mono/<br>Multiplex Source       | Last Valid    | Set the listening mode for playing Dolby Digital, AAC and other digital signals recorded in monaural or multiplex audio.  |
| 2ch Source                      | Last Valid    | Set the listening mode for playing Dolby Digital and other digital signals recorded in 2 channels.  |
| Dolby D/<br>Dolby D Plus/TrueHD | Last Valid    | Set the listening mode for playing Dolby Digital, Dolby Digital Plus and Dolby TrueHD signals.  |
| DTS/DTS-ES/<br>DTS-HD           | Last Valid    | Set the listening mode for playing digital audio signals in DTS and DTS-HD High Resolution formats. Select the listening mode specified for Blu-ray or such other DTS-HD Master Audio source. |
| Other Multich Source            | Last Valid    | Set the listening mode for playing DSD signals of AAC, DVD-Audio and Super Audio CD that are input from HDMI IN jack.   |

- Available listening modes vary depending on the input signal.
- Setting "Last Valid" will always select the last selected mode.
- Only "Analog" can be set to the "TUNER" input.
- "Digital" and "TrueHD" can be set to the "NET" and "USB" inputs.
- Only "Digital" can be set to the "BLUETOOTH" input.



## 6. Miscellaneous

### Volume Setup

Make the detailed volume setting of the unit.

| Setting item    | Default Value | Setting Details   |
|-----------------|---------------|---|
| Maximum Volume  | Off           | Set the maximum value to avoid too high volume. Select a value from "Off", "30" to "79".  |
| Power On Volume | Last          | Set the volume level of when the power is turned on. Select a value from "Last" (Volume level before entering standby mode), "Min", "1" to "79" and "Max". <ul style="list-style-type: none"> <li>You cannot set a higher value than that of "Maximum Volume".</li> </ul> |
| Headphone Level | 0 dB          | Adjust the volume level difference between speakers and headphones. Select a value between "-12 dB" to "+12 dB".  |

### OSD Setup

Make the setting of on-screen display function that can display the setting menu screen, volume operation screen and the like on the TV.

| Setting item      | Default Value | Setting Details  |
|-------------------|---------------|--|
| On Screen Display | On            | Set whether or not to display the operation screen on the TV.<br>"On": The operation screen will be displayed on the TV.<br>"Off": The operation screen will not be displayed on the TV.<br><ul style="list-style-type: none"> <li>The operation screen may not be displayed depending on the input signal even if "On" is selected. If the operation screen is not displayed, change the resolution of the connected device.</li> </ul> |
| Language          | English       | Select the on-screen display language.   |
| Screen Saver      | 3min          | Set the time to start the screen saver. Select a value from "3min", "5min", "10min" and "Off".   |

## 7. Hardware Setup

### Tuner

| Setting item   | Default Value | Setting Details   |
|--|---------------|---|
| AM/FM Frequency Step (North American and Taiwanese models) | 10kHz/200kHz  | Select a frequency step depending on your area of residence.<br>Select "10kHz/200kHz" or "9kHz/50kHz". <ul style="list-style-type: none"> <li>When this setting is changed, all radio presets are deleted.</li> </ul> |
| AM Frequency Step (European, Australian and Asian models)  | 9kHz          | Select a frequency step depending on your area of residence.<br>Select "10kHz" or "9kHz". <ul style="list-style-type: none"> <li>When this setting is changed, all radio presets are deleted.</li> </ul>              |

## HDMI

| Setting item    | Default Value | Setting Details  |
|-----------------|---------------|--|
| HDMI CEC (RIHD) | Off           | <p>Setting to "On" enables the input selection link and other link functions with HDMI connected CEC compliant device.</p> <p>"On": Use this function<br/>           "Off": Do not use this function</p> <ul style="list-style-type: none"> <li>Depending on the TV set, a link may need to be configured on the TV.</li> <li>This function is effective only when the device is connected to the HDMI OUT MAIN terminal.</li> <li>Setting to "On" and closing the on-screen menu displays the name of the CEC-compatible components and "RIHD On" on the display.</li> <li>Power consumption in standby mode may increase if "On" is set. (Depending on the TV status, the unit will enter the normal standby mode.)</li> <li>If you operate the MASTER VOLUME control of the unit when this setting is set to "On" and you are listening to the audio through the speakers of your TV, audio will be output also from the speakers connected to the unit. If you want to output from only either of them, change the unit or TV settings, or reduce the volume of the unit.</li> <li>If abnormal operation occurs when you set the setting to "On", set it to "Off".</li> <li>When connecting a non-CEC compatible component, or when you are not sure whether it is compatible, set the setting to "Off".</li> <li>When changing this setting, turn off and then on again the power of all connected components.</li> </ul> |

| Setting item | Default Value | Setting Details  |
|--------------|---------------|--|
| HDMI Through | Off           | <p>You can display the video of an HDMI connected player on the TV even if the unit is in standby mode. This setting is effective only for an input selector to which an HDMI jack is assigned in "HDMI Input". It cannot be set to any other input selector unless an HDMI jack is assigned to it.</p> <p>"Off": The setting is disabled. Video of device connected to any jack will not be displayed.</p> <p>"BD/DVD", "CBL/SAT", "STB/DVR", "GAME", "PC", "AUX", "TV/CD", "PHONO": Video of the device connected to the HDMI IN jack assigned to each input will be displayed on the TV.</p> <p>"Last": Video of the device connected to the HDMI IN jack assigned to the input selector that was selected immediately before the unit enters standby mode will be displayed on the TV.</p> <p>"Auto": Video of all the devices connected to the HDMI IN jacks will be output to the TV.</p> <p>"Eco": Video of all the devices connected to the HDMI IN jacks will be output to the TV. If you select this setting when using a CEC-compatible TV, you can reduce the power consumption in standby mode. It cannot be selected if "HDMI CEC (RIHD)" is set to "Off".</p> <ul style="list-style-type: none"> <li>When "HDMI Through" is enabled, the power consumption increases even when the unit is on standby. However, the increase in power consumption is kept to a minimum by automatically entering the HYBRID STANDBY mode, where only the essential circuit is operating.</li> <li>When changing the setting, turn off and then on again the power of all connected components.</li> </ul> |

| Setting item        | Default Value | Setting Details  |
|---------------------|---------------|--|
| Audio TV Out (MAIN) | Off           | <p>You can enjoy audio through the speakers of the HDMI connected TV while this unit is on.</p> <p>"On": Use this function<br/> "Off": Do not use this function</p> <ul style="list-style-type: none"> <li>• If you select "On", set "HDMI CEC (RIHD)" to "Off."</li> <li>• The setting is fixed to "Auto" if "HDMI CEC (RIHD)" is set to "On".</li> <li>• Listening mode cannot be changed if "Audio TV Out (MAIN)" is set to "On" and audio is being output through the speakers of the TV.</li> <li>• Depending on your TV set or input signal of the component, audio may not output through the speakers of the TV even if this setting is set to "On". In such case, audio is output from the speakers of the unit.</li> <li>• If you operate the MASTER VOLUME control of the unit when "Audio TV Out (MAIN)" or "HDMI CEC (RIHD)" is set to "On" and you are listening to the audio through the speakers of your TV, audio will be output from the unit. If you do not want to output audio from the unit, change the unit or TV settings, or reduce the volume of the unit.</li> <li>• "Audio TV Out (MAIN)" is fixed to "Off" if "Monitor Out" is set to "SUB".</li> </ul> |

| Setting item         | Default Value | Setting Details  |
|----------------------|---------------|--|
| Audio TV Out (SUB)   | Off           | <p>You can enjoy audio through the speakers of the HDMI connected TV while this unit is on.</p> <p>"On": Use this function<br/> "Off": Do not use this function</p> <ul style="list-style-type: none"> <li>• Listening mode cannot be changed while "Audio TV Out (SUB)" is set to "On" and audio is being output through the speakers of the TV.</li> <li>• Depending on your TV set or input signal of the component, audio may not output through the speakers of the TV even if this setting is set to "On". In such case, audio is output from the speakers of the unit.</li> <li>• If you operate the MASTER VOLUME control of the unit when "Audio TV Out (SUB)" or "HDMI CEC (RIHD)" is set to "On" and you are listening to the audio through the speakers of your TV, audio will be output from the unit.. If you do not want to output audio from the unit, change the unit or TV settings, or reduce the volume of the unit.</li> <li>• "Audio TV Out (SUB)" is fixed to "Off" if "Monitor Out" is set to "MAIN".</li> </ul> |
| Audio Return Channel | -             | <p>You can enjoy sound of the HDMI connected ARC compatible TV through the speakers connected to the unit. To use this function, set "HDMI CEC (RIHD)" to "On" in advance.</p> <p>"Auto": When enjoying the TV sound through the speakers connected to the unit<br/> "Off": When not using the ARC function</p>  |
| Lip Sync             | On            | <p>This setting automatically corrects any desynchronization between the video and audio signals based on data from the HDMI LipSync compatible TV.</p> <p>"On": Automatic correction will be enabled.<br/> "Off": Automatic correction will be disabled.</p>  |
| InstaPrevue          |               | <p>Change the preview display of the video input through HDMI, which will be displayed using "InstaPrevue" in the Home menu.</p> <ul style="list-style-type: none"> <li>• Depending on the video source, the preview thumbnails configured in "InstaPrevue" may not be displayed properly.</li> </ul>  |

| Setting item | Default Value      | Setting Details  |
|--------------|--------------------|--|
| Sub Window   | Multi              | Set how to display preview thumbnails.<br>"Multi": Displays all the thumbnails of HDMI IN1, 2, 3, 4 and FRONT at once.<br>"Single": Displays each thumbnail individually.  |
| Position     | Bottom/Lower Right | Set the position to display preview thumbnails.<br>When "Multi" is selected for "Sub Window":<br>Select from "Top", "Bottom", "Left" and "Right".<br>When "Single" is selected for "Sub Window":<br>Select from "Upper Left", "Upper Right", "Lower Left" and "Lower Right". |

- If "Monitor Out" is set to "MAIN+SUB" and "Audio TV Out (SUB)" is set to "On"
  - Set the audio output of the connected device to "2ch PCM".
  - If the audio input is via other than HDMI, sound of the TV connected to the HDMI OUT SUB jack will not be output.

## Auto Standby

| Setting item | Default Value | Setting Details   |
|--------------|---------------|---|
| Auto Standby | On/Off        | This setting places the unit on standby automatically after 20 minutes of inactivity without any video or audio input.<br>"On": The unit will automatically enter standby mode ("ASb" will light).<br>"Off": The unit will not automatically enter standby mode. <ul style="list-style-type: none"> <li>• "Auto Standby" is appeared on the display and menu screen 30 seconds before the Auto Standby comes on.</li> <li>• "Auto Standby" does not work when Zone 2 is active.</li> <li>• Default values vary depending on the regions.</li> </ul> |
| HDMI Through | Off           | Enable or disable "Auto Standby" while "HDMI Through" is on.<br>"On": The setting will be enabled.<br>"Off": The setting will be disabled. <ul style="list-style-type: none"> <li>• "HDMI Through" cannot be set to "On" if "Auto Standby" is set to "Off".</li> </ul>  |

- When "HDMI Through" is used, the power consumption increases even when the unit is on standby. However, the increase in power consumption is kept to a minimum by automatically entering the HYBRID STANDBY mode, where only the essential circuit is operating.

## Network

Make the network setting.

- When LAN is configured with a DHCP, set "DHCP" to "Enable" to configure the setting automatically. ("Enable" is set by default) To assign fixed IP addresses to each component, you must set "DHCP" to "Disable" and assign an address to this unit in "IP Address" as well as set information related to your LAN, such as Subnet Mask and Gateway.

| Setting item    | Default Value | Setting Details  |
|-----------------|---------------|--|
| Network Standby | Off           | You can turn on the power of the unit via network using an application such as Onkyo Remote.<br>"On": Use this function<br>"Off": Do not use this function <ul style="list-style-type: none"> <li>When "Network Standby" is used, the power consumption increases even when the unit is on standby. However, the increase in power consumption is kept to a minimum by automatically entering the HYBRID STANDBY mode, where only the essential circuit is operating.</li> </ul> |
| Wi-Fi           | Off (Wired)   | Connect the unit to network via wireless LAN router.<br>"On": Wireless LAN connection<br>"Off (Wired)": Wired LAN connection   |
| Wi-Fi Setup     | –             | You can configure wireless LAN settings by pressing ENTER when "Start" is displayed.   |
| Wi-Fi Status    | –             | The information of the connected access point will be displayed.<br>"SSID": SSID of the connected access point.<br>"Security": Security method of the connected access point.<br>"Signal": Signal strength of the connected access point.<br>"Status": Status of the connected access point.   |
| MAC Address     | –             | This is the MAC address of the AV receiver. This value is specific to the component and cannot be changed.   |

| Setting item  | Default Value | Setting Details  |
|---------------|---------------|--|
| DHCP          | Enable        | "Enable": Auto configuration by DHCP<br>"Disable": Manual configuration without DHCP <ul style="list-style-type: none"> <li>If selecting "Disable", you must set "IP Address", "Subnet Mask", "Gateway", and "DNS Server" manually.</li> </ul> |
| IP Address    | –             | Displays/Sets the IP address.  |
| Subnet Mask   | –             | Displays/Sets the subnet mask.   |
| Gateway       | –             | Displays/Sets the gateway.   |
| DNS Server    | –             | Displays/Sets the primary DNS server.  |
| Proxy URL     | –             | Displays/Sets the proxy server URL.  |
| Proxy Port    | –             | Displays/Sets the proxy server port number when you enter "Proxy URL".   |
| Network Check | –             | You can check the network connection. Press ENTER when "Start" is displayed.   |

- Wait for a while if "Network" is not shown on the screen. It will appear when the network function is started up.

## Bluetooth

| Setting item         | Default Value | Setting Details  |
|----------------------|---------------|--|
| Bluetooth            | On            | Select whether or not to use the Bluetooth function.<br>"On": Enables connection with a Bluetooth-enabled device by using the Bluetooth function. Select "On" also when making various Bluetooth settings.<br>"Off": When not using the Bluetooth function   |
| Direct Change        | On            | The input of the unit will automatically be switched to "BLUETOOTH" when connection is made from a Bluetooth-enabled device to the unit.<br>"On": The input will automatically become "BLUETOOTH" when a Bluetooth-enabled device is connected.<br>"Off": The function is disabled. <ul style="list-style-type: none"> <li>If the input is not switched automatically, set to "Off" and change the input manually.</li> </ul>  |
| Auto Reconnect       | On            | This function automatically reconnects to the Bluetooth-enabled device connected last when you change the input selector to "BLUETOOTH".<br>"On": Use this function<br>"Off": Do not use this function <ul style="list-style-type: none"> <li>This function may not work depending on your Bluetooth-enabled device.</li> </ul>  |
| Wakeup via Bluetooth | Off           | This function wakes up the unit on standby by connecting a Bluetooth-enabled device.<br>"On": Use this function<br>"Off": Do not use this function <ul style="list-style-type: none"> <li>Setting to "On" increases the power consumption even when the unit is on standby. However, the increase in power consumption is kept to a minimum by automatically entering the HYBRID STANDBY mode, where only the essential circuit is operating.</li> <li>"Wakeup via Bluetooth" is fixed to "Off" if "Direct Change" is set to "Off".</li> </ul> |

| Setting item        | Default Value | Setting Details  |
|---------------------|---------------|--|
| Pairing Information | -             | When pairing is performed, the information of the previous pairing stored in this unit will be initialized.<br>Pressing ENTER when "Clear" is displayed initializes the pairing information stored in this unit. <ul style="list-style-type: none"> <li>This function does not initialize the pairing information on the Bluetooth-enabled device. When pairing the unit again with the device, be sure to clear the pairing information on the Bluetooth-enabled device in advance. For information on how to clear the pairing information, refer to the Bluetooth-enabled device's instruction manual.</li> </ul> |
| Device              | -             | Displays the name of the Bluetooth-enabled device connected to the unit. <ul style="list-style-type: none"> <li>The name is not displayed when "Status" is "Ready" and "Pairing".</li> </ul>   |
| Status              | -             | Displays the status of the Bluetooth-enabled device connected to the unit.<br>"Ready": Not paired<br>"Pairing": Paired<br>"Connected": Successfully connected  |

## Firmware Update

| Setting item   | Default Value | Setting Details   |
|----------------|---------------|---|
| Update Notice  | Enable        | Availability of a firmware update will be notified via network.<br>"Enable": Notify updates<br>"Disable": Do not notify updates   |
| Version        | -             | The current firmware version will be displayed.   |
| Update via NET | -             | Press ENTER to select when you want to update the firmware via network. <ul style="list-style-type: none"> <li>You will not be able to select this setting if you do not have Internet access or there is nothing to update.</li> </ul> |

| Setting item   | Default Value | Setting Details  |
|----------------|---------------|--|
| Update via USB | –             | <p>Press ENTER to select when you want to update the firmware via USB.</p> <ul style="list-style-type: none"> <li>You will not be able to select this setting if a USB storage device is not connected or there is nothing to update in the USB storage device.</li> </ul> |

### Initial Setup

You can make the initial setup from the setup menu.

- Setting is not possible if "Monitor Out" is set to "SUB".

## 8.Remote Controller Setup

| Setting item      | Default Value | Setting Details  |
|-------------------|---------------|--|
| Remote ID         | 1             | <p>Select an ID for the unit's remote controller from "1", "2", and "3" to prevent interference between the unit and other Onkyo components that are installed in the same room. After changing the ID on the main unit, change the ID on the remote controller accordingly with the following procedure.</p> <ol style="list-style-type: none"> <li>While holding down RCV, press Q SETUP for about 3 seconds until the remote indicator lights.</li> <li>With the number buttons, press one of 1, 2, and 3. The remote indicator flashes twice.</li> </ol> |
| Remote Mode Setup | –             | <p>Input and register the remote controller code of other devices.</p> <ul style="list-style-type: none"> <li>For registration of the remote control code, refer to "Operating Other Components with the Remote Controller".</li> </ul>  |

## 9.Lock Setup

| Setting item | Default Value | Setting Details   |
|--------------|---------------|---|
| Setup        | Unlocked      | <p>The Setup menu will be locked to protect the settings.</p> <p>"Locked": The menu is locked.</p> <p>"Unlocked": The menu is unlocked.</p> |

## Operating Other Components Using Remote Controller

### Functions of REMOTE MODE Buttons

You can control any other device than this unit by programming a specified remote control code to a REMOTE MODE button of the remote controller. Register a remote control code to a desired REMOTE MODE button and press it to enter the remote mode that allows you to operate the corresponding device.

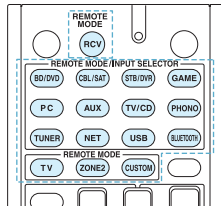

\* The RCV and ZONE2 buttons cannot be programmed.

### Programming Remote Control Codes

For information on the configuration and operation of Onkyo components with RI jack, refer to "Connecting and Operating Onkyo RI Components". Furthermore, the following REMOTE MODE buttons are preprogrammed with remote control codes.

BD/DVD: Onkyo Blu-ray Disc/DVD player

TV/CD: Onkyo CD player

STB/DVR: Apple TV

### ■ Searching in the Setup Menu

You can search a remote control code and register it to a desired REMOTE MODE button in the unit's Setup menu.

1. Press RCV and then press HOME on the remote controller.

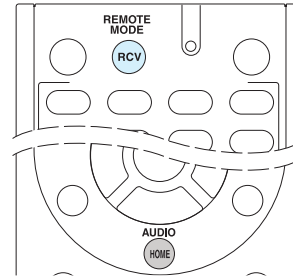

2. With the cursors, select "Setup", and then press ENTER.
3. With the cursors, select "8.Remote Controller Setup" - "Remote Mode Setup" and press ENTER.
4. With the cursors, select the remote mode for which you want to search a remote control code and press ENTER to display the category selection screen.
5. With the cursors, select the target category, and then press ENTER to display the brand name input screen.
6. Select a character with the cursors and press ENTER. Repeat it to enter the first three characters of the brand name.
7. With the cursors, select "Search", and then press ENTER.
  - After a search is done, the list of possible brand names is displayed. If the brand name list is not displayed, select "Not Listed" with the cursors and press ENTER to return to the brand name input screen in step 6.
8. With the cursors, select the target brand name, and then press ENTER.
  - Once you decided the corresponding brand name, the remote control code of the brand and how to register it will be displayed on the TV screen.
9. Follow the guidance displayed on the TV screen.
10. If the component can successfully be operated with its registered remote control code, select "OK" with the cursors and press ENTER.
  - Only TV remote control codes can be entered for TV.
  - Program a remote control code in accordance with the input since each button also works as the input selector. (For example, when the CD player is

connected to the TV/CD jack, program the remote control code for the CD player to TV/CD)

- If the component cannot be operated, select "Try Next Code" with the cursors and press ENTER to display another code.
- It is possible to operate an MHL-enabled mobile device with the unit's remote controller by registering the code of the MHL-enabled mobile device below to the unit's remote controller. Operation may be unstable or incorrect depending on the mobile device used.  
33101 (North American and Taiwanese models)  
32910 (European, Australian and Asian models)

### ■ Consulting the Remote Control Code List

Find the remote control code in the remote control code list.

1. Look up the [Remote Control Code List](#) for the corresponding remote control code.
  - The codes in the Remote Control Code List are those known as of the date of publication and may be changed.
  - Only TV remote control codes can be entered for TV.
  - Program a remote control code in accordance with the input since each button also works as the input selector. (For example, when the CD player is connected to the TV/CD jack, program the remote control code for the CD player to TV/CD)



- 2. Press DISPLAY for 3 or more seconds while holding down the REMOTE MODE button to which you want to register the remote control code.

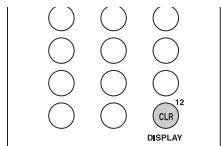

Once you entered the input mode, the remote indicator will light.

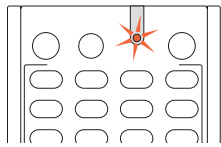

- 3. With the number buttons, enter the 5-digit remote control code within 30 seconds.

- The registration is complete when the remote indicator flashes twice. The remote indicator flashes once slowly when registering the remote control code fails. Try the registration again.

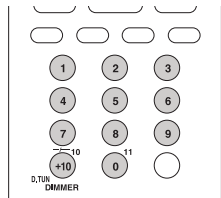

■ Remapping the Colored Buttons

The colored button assignment on the AV receiver's remote controller can be remapped to match that on the remote controller of the component whose remote control code you programmed to REMOTE MODE. However, you will not be able to remap the colored buttons if Zone 2 is selected.

- 1. Hold down the REMOTE MODE button to map and A (Red) simultaneously until the remote indicator lights (about 3 seconds).
  - Remapping is possible only for codes included in the categories of the Remote Control Code List such as DVD player and TV.

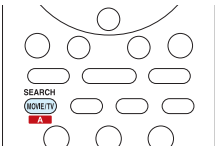

- 2. Within 30 seconds, press the colored buttons from left to right, in the order you want to remap.
  - For example, if the colored buttons on the remote controller of the other component are yellow, green, blue, and red from left to right, press the buttons on the AV receiver's remote controller in that order.
  - Programming is complete when the remote indicator flashes twice. The remote indicator flashes once slowly when programming the remote control code fails. Try the remapping again.
  - Pressing any other button than a colored button cancels the remap operation.

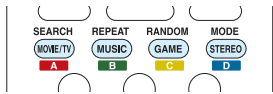

■ Resetting the REMOTE MODE Buttons

You can reset the remote control code registered in the REMOTE MODE button to its default status. This operation can be executed on a single REMOTE MODE button.

- 1. Press HOME for 3 or more seconds while holding down the REMOTE MODE button you want to reset.

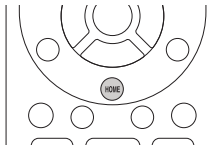

The remote indicator will light.

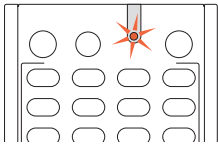

- 2. Within 30 seconds, press the REMOTE MODE button again.
  - Reset is complete when the remote indicator flashes twice.

**To reset all the remote controller settings**, while holding down RCV, press and hold down HOME until the remote indicator lights (about 3 seconds). Press RCV again within 30 seconds. Reset is complete when the remote indicator flashes twice.

## TV operation

Press the REMOTE MODE button programmed with the remote control code for the relevant AV component to switch the remote controller mode to that for the AV component. Then, operate by using the corresponding buttons. Available buttons vary depending on the product category of the component. Operation may be incorrect or impossible depending on the product.

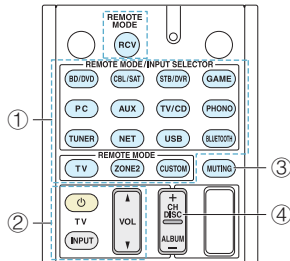

- ① REMOTE MODE
- ② INPUT, VOL ▲/▼
- ③ MUTE
- ④ CH +/-

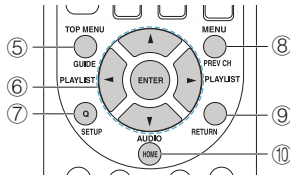

- ⑤ GUIDE
- ⑥ ▲/▼/◀/▶, ENTER
- ⑦ SETUP
- ⑧ PREV CH
- ⑨ RETURN
- ⑩ AUDIO (\*)

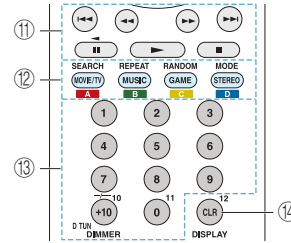

- ⑪ ►, ■, ■, ◀, ►►, ◀◀, ►◀, ►►► (\*)
- ⑫ A (Red) (\*), B (Green) (\*), C (Yellow) (\*), D (Blue) (\*)
- ⑬ Number 1 to 9, 0, +10
- ⑭ CLR, DISPLAY

\* Not CEC-compatible.

## Blu-ray Disc player/DVD player/DVD recorder operation

Press the REMOTE MODE button programmed with the remote control code for the relevant AV component to switch the remote controller mode to that for the AV component. Then, operate by using the corresponding buttons. Available buttons vary depending on the product category of the component. Operation may be incorrect or impossible depending on the product.

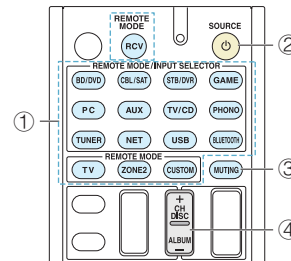

- ① REMOTE MODE
- ② SOURCE
- ③ MUTE
- ④ CH +/-, DISC +/-

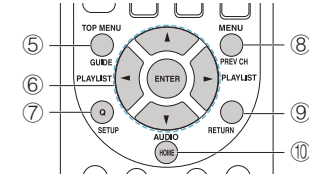

- ⑤ TOP MENU
- ⑥ ▲/▼/◀/▶, ENTER
- ⑦ SETUP
- ⑧ MENU
- ⑨ RETURN
- ⑩ AUDIO (\*)

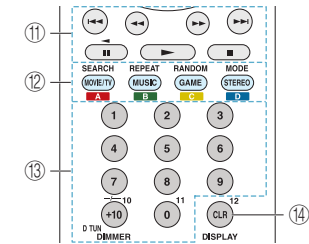

- ⑪ ►, ■, ■, ◀, ►►, ◀◀, ►◀, ►►►
- ⑫ A (Red) (\*), B (Green) (\*), C (Yellow) (\*), D (Blue) (\*)
- ⑬ Number 1 to 9, 0, +10 (\*)
- ⑭ CLR, DISPLAY

\* Not CEC-compatible. ("A (Red) (\*), B (Green), C (Yellow) (\*), D (Blue) (\*)" are intended only for "DVD player/DVD recorder")

### VCR/PVR operation

Press the REMOTE MODE button programmed with the remote control code for the relevant AV component to switch the remote controller mode to that for the AV component. Then, operate by using the corresponding buttons. Available buttons vary depending on the product category of the component. Operation may be incorrect or impossible depending on the product.

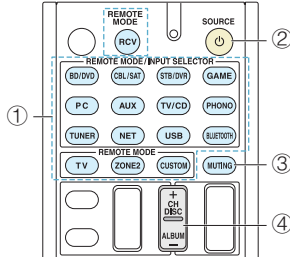

- ① REMOTE MODE
- ② SOURCE
- ③ MUTING
- ④ CH +/-

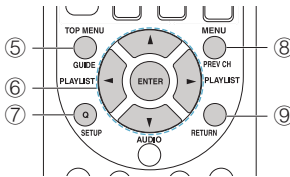

- ⑤ GUIDE
- ⑥ ▲/▼/◀/▶, ENTER
- ⑦ SETUP
- ⑧ PREV CH
- ⑨ RETURN

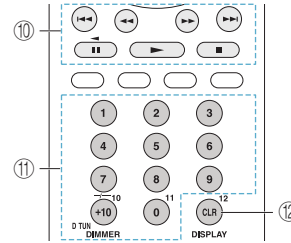

- ⑩ ►►, ►►, ■, ◀◀, ◀◀, ◀◀, ◀◀, ►►►
- ⑪ Number 1 to 9, 0, +10
- ⑫ CLR, DISPLAY

### Satellite receiver / Cable receiver operation

Press the REMOTE MODE button programmed with the remote control code for the relevant AV component to switch the remote controller mode to that for the AV component. Then, operate by using the corresponding buttons. Available buttons vary depending on the product category of the component. Operation may be incorrect or impossible depending on the product.

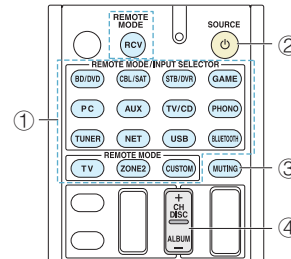

- ① REMOTE MODE
- ② SOURCE
- ③ MUTING
- ④ CH +/-

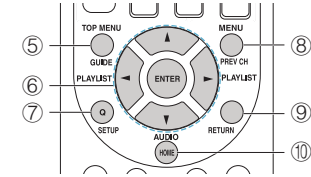

- ⑤ GUIDE
- ⑥ ▲/▼/◀/▶, ENTER
- ⑦ SETUP
- ⑧ PREV CH
- ⑨ RETURN
- ⑩ AUDIO

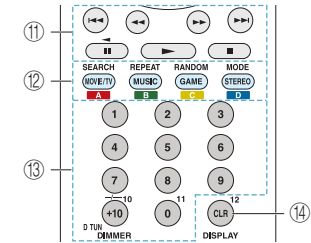

- ⑪ ►►, ►►, ■, ◀◀, ◀◀, ◀◀, ◀◀, ►►►
- ⑫ A (Red) B (Green), C (Yellow), D (Blue)
- ⑬ Number 1 to 9, 0, +10
- ⑭ CLR, DISPLAY

### CD player operation

Press the REMOTE MODE button programmed with the remote control code for the relevant AV component to switch the remote controller mode to that for the AV component. Then, operate by using the corresponding buttons. Available buttons vary depending on the product category of the component. Operation may be incorrect or impossible depending on the product.

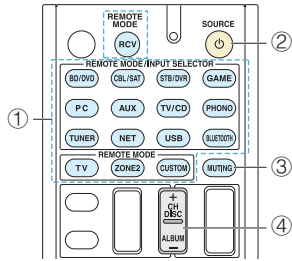

- ① REMOTE MODE
- ② SOURCE
- ③ MUTE
- ④ DISC +/-

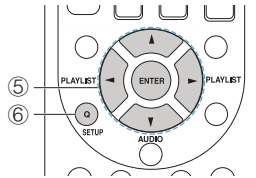

- ⑤ ▲/▼/◀▶, ENTER
- ⑥ SETUP

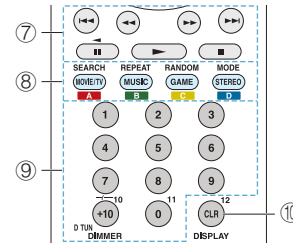

- ⑦ ▶, ||, ■, ◀▶, ▶▶, ◀◀, ▶▶▶
- ⑧ SEARCH, REPEAT, RANDOM, MODE
- ⑨ Number 1 to 9, 0, +10
- ⑩ CLR, DISPLAY

### Cassette tape deck operation

Press the REMOTE MODE button programmed with the remote control code for the relevant AV component to switch the remote controller mode to that for the AV component. Then, operate by using the corresponding buttons. Available buttons vary depending on the product category of the component. Operation may be incorrect or impossible depending on the product.

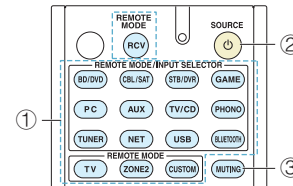

- ① REMOTE MODE
- ② SOURCE
- ③ MUTE

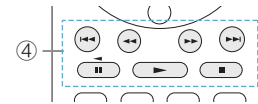

- ④ ▶, ◀ (Reverse Playback), ■, ◀◀, ▶▶, ◀◀◀, ▶▶▶

### To operate CEC-compatible components

The TV and BD/DVD buttons on the remote controller are preprogrammed with remote control codes for linked operation of some CEC (Consumer Electronics Control)-compatible TV sets and Blu-ray Disk players. By connecting to the unit via HDMI, you may operate them using the AV receiver's remote controller.

- If you cannot operate your CEC-compatible component, program one of the following remote control codes to the TV or BD/DVD button.  
 TV: 11807/13100/13500 (CEC-compatible TV)  
 BD/DVD: 32910/33101/33501/31612 (CEC-compatible BD/DVD player)

## Advanced Speaker Connection

### Bi-Amping

It is possible to connect speakers supporting bi-amping to improve quality of the low and high pitched ranges. Up to 5.1 ch will be played in bi-amping.

#### ■ Connections

1. Connect as below using the FRONT terminals and BACK or HEIGHT terminals.

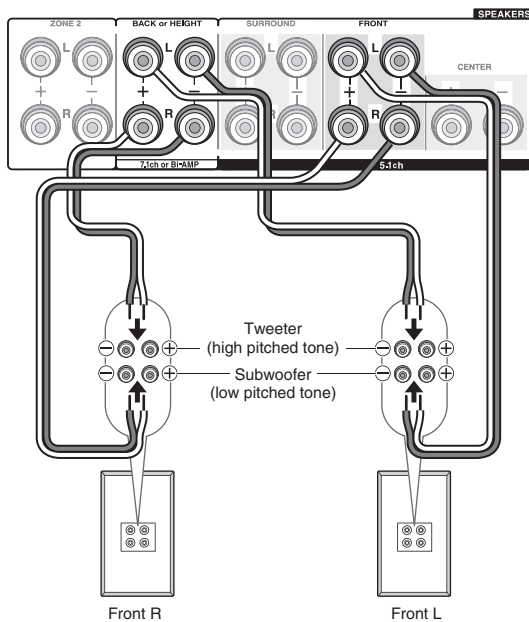

2. Turn the unit on and set "Speaker Setup" to "Bi-Amp".

- ① After pressing RCV, press HOME on the remote controller.
- ② With the cursors, select "Setup", and then press ENTER.

- ③ With the cursors, select the order of "2.Speaker Setup" – "Speaker Settings" – "Front Speakers Type".
- ④ Select "Bi-Amp" with the cursors and press ENTER.
  - Before bi-amping, be sure to remove the short-circuit connector that connects the tweeter (high pitched tone) terminal and the subwoofer (low pitched tone) terminal.
  - Use speakers supporting bi-amping only. For details, refer to the speakers' instruction manual.

# Connecting and Operating Onkyo RI Components

## About RI Function

Connecting an Onkyo component with RI jack such as the separately sold RI Dock to the unit by using an RI cable and an analog audio (RCA) cable enables the following RI functions:

**System On / Auto Power On:** Starting playback on a component connected via RI when the unit is on standby mode, automatically turns on the unit to select the relevant component as its input source.

**Direct Change:** When playback is started on a component connected via RI, the unit selects that component as the input source.

**Remote Controller Operation:** Allows you to operate RI-compatible Onkyo components using the AV receiver's remote controller. Point the remote controller at remote control sensor of the unit. This operation is possible only when the RI remote control code is programmed.

- Some components may not support all RI functions.
- These functions do not work when Zone 2 is turned on.
- For information on the RI functions, also refer to each component's instruction manual.

## RI Connection and Setting

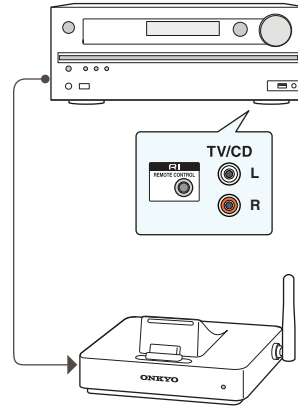

Connect an Onkyo component with RI jack to this unit using an RI cable and an analog audio (RCA) cable. For details, refer to the instruction manual of the component with RI jack. The RI cable can be connected in any order. When there are two RI jacks, both jacks work in the same way and are interchangeable.

To connect the RI Dock or cassette tape deck via RI, you must:

### ■ Rename the input selector

To make the RI functions work, you must rename the input selectors on the unit. Press TV/CD or GAME to display "TV/CD" or "GAME" on the main unit display. Then press and hold TV/CD or GAME 3 seconds or more to switch the display to "DOCK" or "TAPE".

### ■ Program the RI remote control code

Program the remote control code to any REMOTE MODE button on the remote controller. This will allow you to operate the component by pointing the remote controller at the unit instead of the component.

1. Press DISPLAY for 3 or more seconds while holding down the REMOTE MODE button to which you want to program the remote control code.
  - The remote indicator will light.

## Connecting and Operating Onkyo RI Components

- The RCV, ZONE2, and TV buttons cannot be programmed.

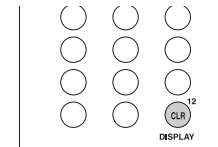

2. With the number buttons, enter the following 5-digit remote control code within 30 seconds.

RI Dock: 81993

Cassette tape deck with RI jack: 42157

- Programming is complete when the remote indicator flashes twice. The remote indicator flashes once slowly when programming the remote control code fails. Try again.

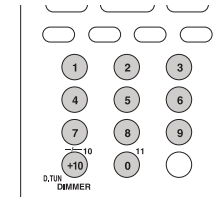

**Change the input selector on the RI Dock to "HDD" or "HDD/DOC".** For details, refer to the RI Dock's instruction manual.

To operate Onkyo components directly or Onkyo components that are not connected via RI, use the following remote control codes:

Onkyo DVD player: 30627

Onkyo CD player: 71817

RI Dock: 82990

- With some models, operation may be not possible in part or not possible at all.

## iPod/iPhone Operation

The RI Dock allows you to use the AV receiver's remote controller to operate and play music on your iPod/iPhone. Moreover, it also allows you to view videos on your iPod/iPhone on the screen of your TV, as well as perform RI operations if connected via RI. This operation is possible only when the RI remote control code is programmed.

**Before Operation:** Before performing any operation on your iPod/iPhone, make sure to have it updated to the latest version via iTunes. Certain buttons may not work for some iPod/iPhone models and generations, or RI Dock. For details on the operation, refer to the RI Dock's instruction manual.

Switch the remote controller mode by pressing the REMOTE MODE button programmed with the remote control code for the iPod/iPhone, and operate by using the corresponding buttons. Point the remote controller at the unit.

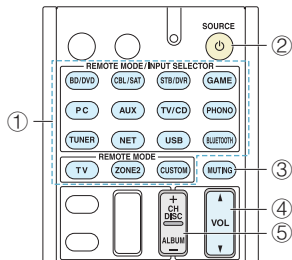

- ① REMOTE MODE
- ② SOURCE
- ③ MUTING
- ④ VOL ▲/▼
- ⑤ ALBUM +/-

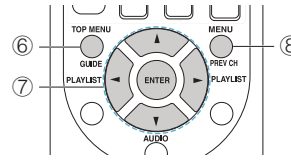

- ⑥ TOP MENU
- ⑦ ▲/▼/◀/▶, ENTER, PLAYLIST ◀▶
- ⑧ MENU

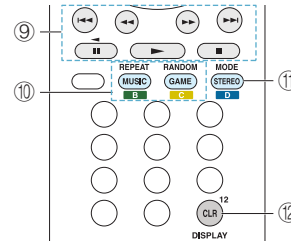

- ⑨ ▶, ||, ■, ◀▶, I◀◀, ▶▶
- ⑩ REPEAT, RANDOM
- ⑪ MODE
- ⑫ DISPLAY

- Pressing DISPLAY turns on the backlight for a few seconds.
- MODE allows you to use the Resume function to resume playing from the song that was playing when you removed your iPod/iPhone from the DS-A2 RI Dock.

## Firmware Update

### About Firmware Update

There are two methods for updating the firmware: via network and via USB.

Use the one that best suits your environment.

- For the latest information on updates, visit the Onkyo website.
- Before updating, make sure that the speaker setup microphone is not connected.
- During an update, do not
  - Disconnect and reconnect any cable, USB storage device, speaker setup microphone or headphones, or perform any operation on the component such as turn off its power
  - Access to this unit from a PC or smartphone using Android application
- The update may take about 20 minutes to complete for either method: via network or via USB. Furthermore, existing settings are guaranteed regardless of the method used for update.

**Disclaimer:** The program and accompanying online documentation are furnished to you for use at your own risk.

Onkyo will not be liable and you will have no remedy for damages for any claim of any kind whatsoever concerning your use of the program or the accompanying online documentation, regardless of legal theory, and whether arising in tort or contract.

In no event will Onkyo be liable to you or any third party for any special, indirect, incidental, or consequential damages of any kind, including, but not limited to, compensation, reimbursement or damages on account of the loss of present or prospective profits, loss of data, or for any other reason whatsoever.

### Updating the Firmware via Network

#### Before Start:

- Check that the unit is turned on, and the connection to the Internet is secured.
  - Turn off the controller component (PC etc.) connected to the network.
  - Stop any playing Internet radio, USB storage device, or server content.
  - If Zone 2 is active, press OFF on the unit to turn it off.
  - If "HDMI CEC (RIHD)" is set to "On", set it to "Off" (default value).
    - After pressing RCV, press HOME on the remote controller. Select "Setup" with the cursors and press ENTER. Then, after selecting "7.Hardware Setup" - "HDMI" and pressing ENTER, select "HDMI CEC (RIHD)" to select "Off".
- \* The description may differ from the on-screen display but that will not change the way to operate or the function.

#### Update

1. After pressing RCV, press HOME on the remote controller.

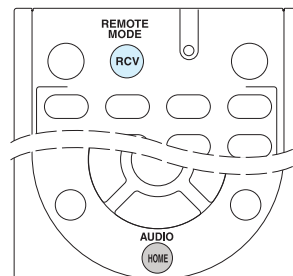

The Home menu is displayed on the TV screen.

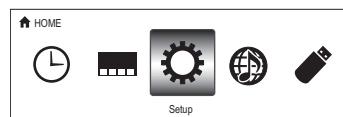

2. With the cursors, select "Setup" - "7.Hardware Setup" - "Firmware Update" - "Update via NET", and then press ENTER.
  - If "7.Hardware Setup" is grayed out and cannot be selected, wait for a while until it starts up.
  - You will not be able to select "Update via NET" if there is nothing to update.
3. Press ENTER with "Update" selected to start update.
  - During the update, the TV screen may go black depending on the updated program. In that case, check the progress on the display of the unit. The TV screen will remain black until the update is complete and the power is turned on again.
  - "Completed!" is displayed when the update is complete.
4. Press ON/STANDBY on the main unit to turn the unit into standby mode. This is the end of the firmware update and you have now the latest firmware installed.
  - Do not use RECEIVER on the remote controller.

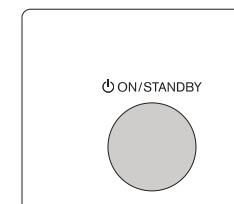



## ■ If an Error Message is Displayed

Case 1: When an error occurs, "\*-\* Error!" is appeared on the display of the unit. ("\*" represents an alphanumeric character.) Check the following:

### Error Code

#### • \*-01, \*-10:

Ethernet cable not found. Connect the Ethernet cable properly.

#### • \*-02, \*-03, \*-04, \*-05, \*-06, \*-11, \*-13, \*-14, \*-16, \*-17, \*-18, \*-20, \*-21:

Internet connection error. Check the following:

- Whether the router is turned on
- Whether this unit and router are connected to the network

Try to disconnect and then connect again the power to the unit and router. This may solve the problem. If you are still unable to connect to the Internet, the DNS server or proxy server may be temporarily down. Check the service status with your ISP provider.

#### • Others:

disconnect then reconnect the AC power cord, from the beginning.

## Updating the Firmware via USB

### Before Start:

- Prepare a 64 MB or larger USB storage device.
    - Media inserted in a USB card reader may not be used for this function.
    - USB storage devices with security function are not supported.
    - USB hubs and USB devices with hub function are not supported. Do not connect these devices to the unit.
  - Delete any data stored on the USB storage device.
  - Turn off the controller component (PC etc.) connected to the network.
  - Stop any playing Internet radio, USB storage device, or server content.
  - If Zone 2 is active, press OFF on the unit to turn it off.
  - If "HDMI CEC (RIHD)" is set to "On", set it to "Off" (default value).
    - After pressing RCV, press HOME on the remote controller. Select "Setup" with the cursors and press ENTER. Then, after selecting "7.Hardware Setup" - "HDMI" and pressing ENTER, select "HDMI CEC (RIHD)" to select "Off".
- \* Some USB storage devices may take long to load, may not be loaded correctly, or may not be correctly fed depending on the device or their content.
- \* Onkyo will not be liable whatsoever for any loss or damage of data, or storage failure arising from the use of the USB storage device with this AV receiver. Thank you for your understanding.
- \* The description may differ from the on-screen display but that will not change the way to operate or the function.

## ■ Update

1. Connect the USB storage device to your PC.
2. Download the firmware file from the Onkyo website to your PC and unzip.
 

Firmware files are named in the following way:  
ONKAVR\*\*\*\*\*\_\*\*\*\*\*.zip

Unzip the file on your PC. The number of unzipped files and folders varies depending on the model.
3. Copy all unzipped files and folders to the root folder of the USB storage device.
  - Make sure to copy the unzipped files.
4. Press USB on the remote controller to select "USB".

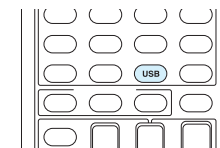

5. Connect the USB storage device to the USB port of the unit.
  - If you connect a USB hard disk drive to the USB port of the unit, we recommend that you use its AC adapter to power it.
  - If the USB storage device has been partitioned, each section will be treated as an independent device.

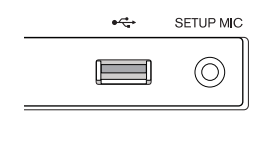

6. After pressing RCV, press HOME on the remote controller.

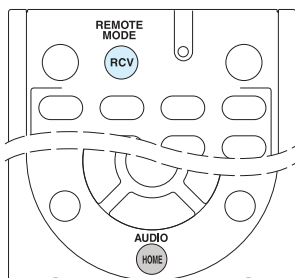

The Home menu is displayed on the TV screen.

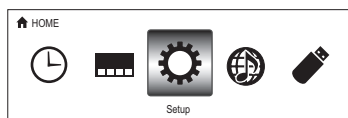

7. With the cursors, select "Setup" - "7.Hardware Setup" - "Firmware Update" - "Update via USB", and then press ENTER.
- If "7.Hardware Setup" is grayed out and cannot be selected, wait for a while until it starts up.
  - You will not be able to select "Update via USB" if there is nothing to update.
8. Press ENTER with "Update" selected to start update.
- During the update, the TV screen may go black depending on the updated program. In that case, check the progress on the display of the unit. The TV screen will remain black until the update is complete and the power is turned on again.
  - During the update, do not turn off, or disconnect then reconnect the USB storage device.
  - "Completed!" is displayed when the update is complete.
9. Disconnect the USB storage device from the unit.
10. Press ON/STANDBY on the main unit to turn the unit into standby mode. This is the end of the firmware update and you have now the latest firmware installed.
- Do not use RECEIVER on the remote controller.

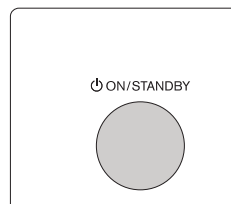

### ■ If an Error Message is Displayed

Case 1: When an error occurs, "\*-\* \* Error!" is appeared on the display of the unit. ("\*" represents an alphanumeric character.) Check the following:

#### Error Code

- **\*-01, \*-10:**  
USB storage device not found. Check whether the USB storage device or USB cable is correctly inserted to the USB port of the unit.  
Connect the USB storage device to an external power source if it has its own power supply.
- **\*-05, \*-13, \*-20, \*-21:**  
The firmware file is not present in the root folder of the USB storage device, or the firmware file is for another model. Retry from the download of the firmware file.
- **Others:**  
disconnect then reconnect the AC power cord, from the beginning.

# Troubleshooting

## Before starting the procedure

Problems may be solved by simply turning the power on/off or disconnecting/connecting the power cord, which is easier than working on the connection, setting and operating procedure. Try the simple measures on both the unit and the connected device. If the problem is that the video or audio is not output or the HDMI linked operation does not work, disconnecting/connecting the HDMI cable may solve it. When reconnecting, be careful not to wind the HDMI cable since if wound the HDMI cable may not fit well. After reconnecting, turn off and on the unit and the connected device.

## Resetting the unit

Resetting the unit to the status at the time of shipment may solve the problem. If the measures above do not solve the problem, reset the unit with the following procedure. If you reset the unit status, your preferences will be reset to the defaults. Note them down before starting reset.

### How to reset

1. While holding down CBL/SAT on the main unit (note that step 2 must be performed with this button pressed down)
2. Press  $\text{ON/STANDBY}$  on the unit. "Clear" is appeared on the display and the unit will enter standby mode.

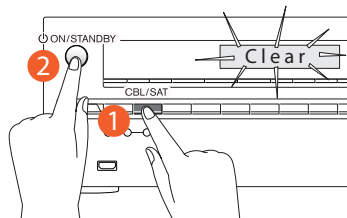

### How to reset the remote controller

1. While holding down ①RCV on the remote controller (note that step 2 must be performed with this button pressed down)
2. Press and hold down ②HOME until the ③ remote indicator lights (about 3 seconds). Within 30 seconds, press ①RCV again.

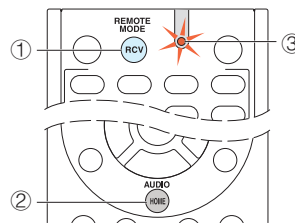

## Power

### Can not turn on the unit

- Make sure that the power cord is properly plugged into the wall outlet.
- Unplug the power cord from the wall outlet, wait 5 seconds or more, then plug it in again.

### The unit turns off unexpectedly

- The unit will automatically enter standby mode when Auto Standby has been set and launches.

### The unit turns off and after restoring the power, it turns off again

- The protection circuit has been activated. Remove the power cord from the wall outlet immediately. Make sure that all speaker cables and input sources are properly connected, and leave the unit with its power cord disconnected for 1 hour. After that, reconnect the power cord and turn the power on. If the unit turns off again, avoid resetting it and unplug the power cord. Then contact your Onkyo dealer.

**Caution:** If "CHECK SP WIRE" is appeared on the display, the speaker cables may be shorting.

**WARNING:** If smoke, smell or abnormal noise is produced by the unit, unplug the power cord from the wall outlet immediately and contact the dealer or Onkyo Support.

## Audio

### There is no sound, or it is very quiet

- Make sure that the proper input source is selected.
- Make sure that connecting plugs are pushed in all the way.
- Make sure that the inputs and outputs of all components are connected properly.
- Make sure that the polarity of the speaker cables is correct, and that no bare wires are in contact with the metal part of speaker terminals.
- Make sure that the input source is properly selected.
- Make sure that the speaker cables are not shorting.
- Check the volume. The volume level is adjustable between Min, 1 to 79, Max (80) It is normal that the unit volume level is set up to 40 or around.
- If the MUTING indicator on the display flashes, press MUTING on the remote controller to unmute the unit.
- While headphones are connected to the PHONES jack, no sound is output from the speakers.
- If there is no sound from a BD/DVD player connected to an HDMI IN, check the BD/DVD player's output settings, and be sure to select a supported audio format.
- Check the digital audio output setting on the connected component. On some game consoles, such as those that support DVD, the default setting is off.
- With some DVD-Video discs, you need to select an audio output format from a menu.
- If your turntable uses an MC cartridge, you must connect an MC head amp, or an MC transformer.
- Make sure that none of the connecting cables are bent, twisted, or damaged.
- Not all listening modes use all speakers.
- Specify the speaker distances and adjust the individual speaker levels.
- Make sure that the speaker setup microphone is not still connected.
- If the input signal format is set to "PCM" or "DTS", set it to "Off".

### Only the front speakers produce sound

- When the Stereo or Mono listening mode is selected, only the front speakers and subwoofer produce sound.
- Make sure the speakers are configured correctly.

#### ■ Only the center speaker produces sound

- If you use the Dolby Pro Logic II listening mode with a mono source, such as an AM radio station or mono TV program, the sound is concentrated in the center speaker.
- Make sure the speakers are configured correctly.

#### ■ The surround speakers produce no sound

- When the T-D (Theater-Dimensional), Stereo or Mono listening mode is selected, the surround speakers produce no sound.
- Depending on the source and current listening mode, not much sound may be produced by the surround speakers. Try selecting another listening mode.
- Make sure the speakers are configured correctly.

#### ■ The center speaker produces no sound

- When the Stereo or Mono listening mode is selected, the center speaker produces no sound.
- Make sure the speakers are configured correctly.

#### ■ The subwoofer produces no sound

- When you play source material that contains no information in the LFE channel, the subwoofer produces no sound.
- Make sure the speakers are configured correctly.

#### ■ There is no sound with a certain signal format

- When listening to Dolby Digital and/or DTS sound, digital connection is necessary.
- Check the digital input terminal setting. If the connection is different from the default, re-setting is necessary.
- Check the digital audio output setting on the connected component. On some game consoles, such as those that support DVD, the default setting is off.

#### ■ Can not select the Pure Audio listening mode (European, Australian and Asian models)

- The Pure Audio listening mode can not be selected while Zone 2 is on.

#### ■ Can not select a desired listening mode

- Depending on the connecting status of the speaker, some listening modes may not be selected. Check the details in "Using the Listening Modes" section.

#### ■ Can not play 5.1ch

- Make sure the speakers are configured correctly.
- Not all listening modes use all speakers.

#### ■ Can not get 6.1/7.1 playback

- 6.1/7.1 playback is not possible if surround back speakers and height speakers are not connected.
- Depending on the number of connected speakers, it is not always possible to select all of the listening modes.

#### ■ The speaker volume cannot be set as required

- Check to see if a maximum volume has been set.

#### ■ Noise can be heard

- Using cable ties to bundle analog audio (RCA) cables with power cords, speaker cables, etc. may degrade the audio performance, so refrain from doing it.
- An analog audio (RCA) cable may be picking up interference. Try repositioning your cables.

#### ■ The Late Night function does not work

- Make sure the source material is Dolby Digital, Dolby Digital Plus, or Dolby TrueHD.

#### ■ About DTS signals

- When DTS program material ends and the DTS bitstream stops, the unit remains in DTS listening mode and the dts indicator remains on. This is to prevent noise when you use the pause, fast forward, or fast reverse function on your player. If you switch your player from DTS to PCM, you may not hear any sound because the unit does not switch formats immediately. In such case, you should stop your player for about 3 seconds and then resume playback.
- With some CD and LD players, you will not be able to playback DTS material properly even though your player is connected to a digital input on the unit. This is usually because the DTS bitstream has been processed (e.g., output level, sampling rate, or frequency response changed) and the unit does not recognize it as a genuine DTS signal. In such cases, you may hear noise.
- Playing DTS program material, using the pause, fast forward, or fast reverse function on your player may produce a short audible noise. This is not a malfunction.

#### ■ The beginning of audio received by an HDMI IN can not be heard

- Since it takes longer to identify the format of an HDMI signal than it does for other digital audio signals, audio output may not start immediately.

## Video

---

#### ■ There is no picture

- Make sure that all video connecting plugs are pushed in all the way.
- Make sure that each video component is properly connected.
- If the TV is connected to the HDMI OUT jack of the unit, set "Monitor Out" to "MAIN" or "SUB" according to the output jack. If the playback source is connected to the video (composite) jack or component video jacks and you want to output the video to the TV via the HDMI OUT jack, set "HDMI Input" to "-----".
- If the video source is connected to a component video input, you must assign that input to an input selector, and your TV must be connected to COMPONENT VIDEO OUT terminal.
- If the video source is connected to a composite video input, your TV must be connected to the MONITOR OUT V terminal.
- If the video source is connected to an HDMI input, you must assign that input to an input selector, and your TV must be connected to the HDMI output(s).
- While the Pure Audio (European, Australian and Asian models) listening mode is selected, the analog video circuitry is turned off and only video signals input through HDMI IN can be output.
- Make sure the switching of input screens is proper at the monitor side such as a TV.
- When the image input from the composite video input terminal does not get displayed, make sure that the component video input terminal is not set to the selected input. If selected, images input from the composite video input terminal can not be output to this input switching. If only composite video input terminal connection is used, set the component video input terminal to "-----".

- Images of a component connected to the composite video input terminal can not be output by converting on the monitor of a TV or other components connected to COMPONENT VIDEO OUT terminal.
- If the input selector to which the input from the TV connected to the HDMI OUT SUB jack is connected is changed on this unit when "Monitor Out" is set to "MAIN+SUB", or "MAIN" and when outputting to Zone 2, the video from the TV connected to HDMI OUT MAIN stops displaying.
- "Resolution" is effective only for the HDMI OUT MAIN jack if "Monitor Out" is set to "MAIN+SUB".

■ **There is no picture from a source connected to an HDMI IN**

- Reliable operation with an HDMI-to-DVI adapter is not guaranteed. In addition, video signals from a PC are not supported.
- Check if "Resolution Error" is displayed on the main unit display when video input via HDMI IN jack is not displayed. In this case, the TV does not support the resolution of the video input from the player. Change the setting on the player.

■ **The on-screen menus do not appear**

- On your TV, make sure that the video input to which this unit is connected is selected.
- Set "On Screen Display" to "On" in "OSD Setup".
- When the unit is not connected to a TV via HDMI OUT MAIN, on-screen menus are not displayed.

**Tuner**

■ **Reception is noisy, FM stereo reception is noisy, or the FM STEREO indicator does not light**

- Re-check the antenna connection.
- Relocate your antenna.
- Move the unit away from your TV or PC.
- Passing cars and airplanes can cause interference.
- Concrete walls weaken radio signals.
- Listen to the station in mono.
- When listening to an AM station, operating the remote controller may cause noise.
- If nothing improves the reception, install an outdoor antenna.

**Remote Controller**

■ **The remote controller does not work**

- Before operating this unit using remote controller, be sure to press RCV.
- Make sure that the batteries are installed with the correct polarity.
- Install new batteries. Do not mix different types of batteries, or old and new batteries.
- Make sure that the remote controller is not too far away from the unit, and that there is no obstruction between the remote controller and the remote control sensor of the unit.
- Make sure that the unit is not subjected to direct sunshine or inverter-type fluorescent lights. Relocate if necessary.
- If the unit is installed in a rack or cabinet with colored-glass doors or if the doors are closed, the remote controller may not work reliably.
- Make sure you have selected the correct remote controller mode.
- When using the remote controller to control other manufacturers' AV components, some buttons may not work as expected.
- Make sure you have entered the correct remote control code.
- Make sure to set the same ID on both the unit and remote controller.

■ **Operating other Onkyo component by using a RI remote control code is not available**

- Make sure that the Onkyo component is properly connected with RI cable. When RI cable is used for connection, make sure to connect analog audio (RCA) cable as well. (Connecting only an RI cable will not be enough.)
- Make sure you have selected the correct remote controller mode.
- Make sure that the input display is correctly set.
- Input the RI remote control code again.
- When the RI remote control code is input, point the remote controller at remote control sensor of the unit.

■ **Can not operate Onkyo components (ones without RI connection) and components of other makers**

- Make sure that the connection with other components is

correct.

- Input a correct remote control code again. If there are several codes, try each code.
- Make sure that the remote controller mode is correctly selected.
- Operate the remote controller by setting toward the light receiving section of each component.
- Some components may not start the operation.

**RI Dock for iPod/iPhone**

■ **There is no sound**

- Make sure your iPod/iPhone is actually playing.
- Make sure your iPod/iPhone is properly inserted in the Dock.
- Make sure the unit is turned on, the correct input source is selected, and the volume is turned up.
- Make sure the plugs are pushed in all the way.
- Try resetting your iPod/iPhone.

■ **There is no video**

- Make sure that your iPod/iPhone model's TV OUT setting is set to On.
- Make sure the correct input is selected on your TV or the unit.
- Some versions of the iPod/iPhone do not output video.

■ **The AV receiver's remote controller does not control my iPod/iPhone**

- Make sure your iPod/iPhone is properly inserted in the Dock. If your iPod/iPhone is in a case, it may not connect properly to the Dock. Always remove your iPod/iPhone from the case before inserting it into the Dock.
- The iPod/iPhone can not be operated while it is displaying the Apple logo.
- Make sure you have selected the correct remote controller mode.
- When you use the AV receiver's remote controller, point it toward this unit.
- Before operating with the remote controller, you may need to play on your iPod/iPhone to make the input selector be recognized.
- Try resetting your iPod/iPhone.
- Depending on your iPod/iPhone model and generation, some buttons may not work as expected.

■ **The unit unexpectedly selects my iPod/iPhone as the input source**

- Always pause iPod/iPhone playback before selecting a different input source. If playback is not paused, the Direct Change function may select your iPod/iPhone as the input source by mistake during the transition between tracks.

■ **iPod/iPhone does not work properly**

- Try reconnecting your iPod/iPhone.

**Zone Function**

■ **There is no sound**

- With Zone function, sound is output only when the signal input source is an external component connected to the analog audio input jacks of the unit, "NET", "USB" or "BLUETOOTH". Zone playback is not possible if the player and the unit are connected via HDMI cable or digital cable. Connect the RCA audio output jacks of the player and the analog audio input jacks of the unit with analog audio (RCA) cable. Also analog audio output setting may be necessary on the player.

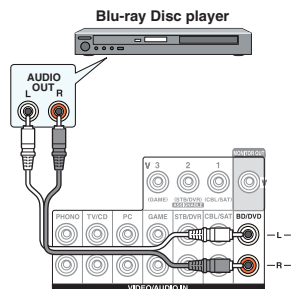

**Wi-Fi (Wireless LAN) Network**

■ **Cannot access to Wi-Fi (Wireless LAN) network or sound playback is interrupted and communication does not work**

- Try plugging/unplugging the power supply of wireless LAN router and the unit, check the wireless LAN router power-on status, and try reboot of the wireless LAN router.

- The setting of SSID and encryption (WEP, etc.) is not correct. Make sure the network settings of the unit is properly set.
- Connection to an SSID that includes multi-byte characters is not supported. Name the SSID of the wireless LAN router using single-byte alphanumeric characters only and try again.
- Can not receive radio wave due to a bad connection. Shorten the distance from wireless LAN access point or remove obstacles for a good visibility, and try again. Place the unit away from microwave ovens or other access points. 2.4 GHz band for wireless LAN may not be enough. Connect ETHERNET terminal of the unit and the router via an Ethernet cable after selecting "7.Hardware Setup" - "Network" and changing "Wi-Fi" to "Off (Wired)".
- Place the unit away from the components emitting electromagnetic waves on the 2.4 GHz band (microwave ovens, game consoles, etc.). If this does not solve the problem, stop using other components which emit electromagnetic waves.
- When other wireless LAN devices are used near the unit, several issues such as interrupted playback and communication may occur. You can avoid these issues by changing the channel of your wireless LAN router. For instructions on changing channels, see the instruction manual provided with your wireless LAN router.
- If there is a metallic object near the unit, wireless LAN connection may not be possible as the metal can effect on the radio wave.
- If there is more than one access point in the network, separate each access point.
- It is recommended to place the Wi-Fi router (access point) and the unit in the same room.

■ **The connection does not complete even when the automatic setting button is pressed on the wireless LAN router**

- The wireless LAN router setting may be switched to Manual. Return the setting to Auto.
- Try the manual set-up. The connection may succeed.

■ **On the list of SSID on the TV menu screen, there is no corresponding SSID**

- When the wireless LAN router setting is at stealth mode (mode to hide the SSID key) or when ANY connection is

off, the SSID is not displayed. Change the setting and try again.

**Bluetooth**

■ **Music playback is unavailable on the unit even after successful Bluetooth connection**

- Depending on the characteristics or specifications of your Bluetooth-enabled device, playback on the unit is not guaranteed.
- When the audio volume of your Bluetooth-enabled device is set low, the playback of audio may be unavailable. Volume up the Bluetooth-enabled device.
- Depending on the Bluetooth-enabled device, Send/Receive selector switch may be provided. Select Send mode.
- Even when a music file is playing on the Bluetooth-enabled device, the sound can not be played if the connection is not established with the unit. Make sure that the unit is connected (this unit is selected as the sound output destination).

■ **Sound is interrupted**

- Problem may be occurring at the Bluetooth-enabled device. Check the information on a webpage.

■ **The audio quality is poor after connection with a Bluetooth-enabled device**

- The Bluetooth reception is poor. Move the Bluetooth-enabled device closer to the unit or remove any obstacle between the Bluetooth-enabled device and this unit.

■ **Can not connect with this unit**

- Try plugging/unplugging the power of the unit and try turning on/off the Bluetooth-enabled device. Re-startup of the Bluetooth-enabled device may be effective.
- The Bluetooth-enabled device does not support the profiles required for this unit.
- The Bluetooth function of the Bluetooth-enabled device is not enabled. Refer to the user manual of the Bluetooth-enabled device for how to enable the function.
- Near components such as microwave oven or cordless phone, which use the radio wave in the 2.4 GHz range, a radio wave interference may occur, which disables the use of this unit.

### ■ Bluetooth connection can not be built

- When building a Bluetooth connection between this unit and your Bluetooth-enabled device for the first time, if the connection fails, select "7.Hardware Setup" - "Bluetooth", execute "Clear" in "Pairing Information", turn off and then on again your Bluetooth-enabled device to clear the device name, and build the connection again.
- If there is a metallic object near the unit, Bluetooth connection may not be possible as the metal can effect on the radio wave.
- If the wireless LAN and Bluetooth connections are used at the same time, try to connect the ETHERNET port and router with the Ethernet cable after selecting "7.Hardware Setup" - "Network" and changing "Wi-Fi" to "Off (Wired)" for a better connection.

### ■ The Bluetooth Auto Reconnect function does not work

- This function may not work depending on your Bluetooth-enabled device. In this case, play on your Bluetooth-enabled device after pairing with this unit.

## NET/USB Function

### ■ Can not access the network server

- When NET is blinking, the AV receiver is not properly connected to the home network.
- Make sure your network server has been started up.
- Make sure your network server is properly connected to the home network.
- Make sure your network server is correctly set.
- Make sure that the router LAN side port is properly connected to the AV receiver.
- Make sure that the correct IP address is allocated in "7.Hardware Setup" - "Network".

### ■ Playback stops while listening to music files on the network server

- Make sure the network server is compatible with this unit.
- When the PC is serving as the network server, try quitting any application software other than the server software (Windows Media Player 12 etc.).
- If the PC is downloading or copying large files, the playback may be interrupted.

### ■ Can not access the Internet radio

- Certain network service or contents available through the unit may not be accessible in case the service provider terminates its service.
- If a specific radio station is unavailable for listening, make sure the registered URL is correct, or whether the format distributed from the radio station is supported by the AV receiver.
- When NET is blinking, the AV receiver is not properly connected to the home network.
- Make sure that your modem and router are properly connected, and make sure they are both turned on.
- Make sure that connecting to Internet from other components is possible. If connecting is not possible, turn off all components connected to the network, wait for a while, and then turn on the components again.
- Make sure that the router LAN side port is properly connected to the AV receiver.
- Make sure that the correct IP address is allocated in "7.Hardware Setup" - "Network".
- Depending on ISP, setting the proxy server is necessary.
- Make sure that the used router and/or modem is supported by your ISP.

### ■ Can not connect to the AV receiver from a Web browser

- Make sure that the IP address of the AV receiver is correctly input to the Internet browser.
- When DHCP is used for allocating the IP address, the IP address of this AV receiver may have been changed.
- Make sure that both AV receiver and PC are properly connected to the network.

### ■ USB storage device is not displayed

- Make sure that USB storage device and USB cable are securely plugged to the USB port of this AV receiver.
- Remove the USB storage device from the AV receiver once, and then try re-connecting.
- Performance of the hard disk that receives power from the USB port of the unit is not guaranteed.
- Depending on the type of format, the playback may not be performed normally. Check the type of the file formats that is supported.
- USB storage device with security functions may not be played.

## Others

### ■ Power consumption in standby mode

- In the following cases, the power consumption in standby mode may reach up to a maximum of 5 W:
  - When "Network Standby" in "7.Hardware Setup" - "Network" is set to "On".
  - When "HDMI CEC (RIHD)" is set to "On". (Depending on the TV status, the AV receiver will enter normal standby mode.)
  - The "HDMI Through" setting is set to other than "Off".
  - When "Wakeup via Bluetooth" in "7.Hardware Setup" - "Bluetooth" is set to "On".
- The power consumption in standby mode may be larger than the value above while the MHL (Mobile High-definition Link) enabled mobile device connected to the AUX INPUT HDMI/MHL jack is being charged.

### ■ The sound changes when I connect my headphones

- When a listening mode other than Direct, Pure Audio (European, Australian and Asian models), or Mono is selected, connecting a headphone automatically selects Stereo.

### ■ The display does not work

- The display is turned off when the Pure Audio (European, Australian and Asian models) listening mode is selected.

### ■ How do I change the language of a multiplex source

- Select "Main" or "Sub" for "Multiplex Input Channel" in "3.Audio Adjust" - "Multiplex/Mono".

### ■ The RI functions do not work

- To use RI, you must make an RI connection and an analog audio (RCA) connection between the component and AV receiver, even if they are connected digitally.
- While Zone 2 is selected, the RI functions do not work.

### ■ The functions System On/Auto Power On and Direct Change do not work for components connected via RI

- These functions do not work when Zone 2 is turned on.

### ■ When performing Automatic Speaker Setup, the measurement fails and the message "Ambient noise is too high." is displayed.

- This can be caused by a malfunction in your speaker unit. Check if the unit produces normal sounds.

### ■ The display is dark

- Make sure that Dimmer function is not working. Press DIMMER button and change the brightness level of the display.

### ■ The following settings can be made for the composite video inputs

- While holding down the input selector button to configure, press HOME once at a time until "Video ATT: On" is appeared on the display. To resume the setup, repeat the above described step until "Video ATT: Off" is appeared on the display.

This setting is possible for input selectors assigned with one of the video inputs "VIDEO 1" to "VIDEO 3" in "1.Input/Output Assign" - "Composite Video Input". If you have a game console connected to the composite video input, and the picture is not very clear, you can attenuate the gain.

Video ATT: Off: (default).

Video ATT: On: (Gain is reduced by 2 dB.)

### ■ If the picture on your TV/monitor connected to the HDMI output(s) is unstable

- Try turning the DeepColor function off. To turn off the DeepColor function, press STB/DVR and  $\odot$ ON/STANDBY on the AV receiver simultaneously. While holding down STB/DVR, press  $\odot$ ON/STANDBY repeatedly until "Deep Color: Off" is appeared on the display. To reactivate the DeepColor function, repeat the above described step until "Deep Color: On" is appeared on the display.

## Radio Wave Caution

The AV receiver uses a 2.4 GHz radio wave frequency, which is a band used by other wireless systems as 1 and 2 described below.

1. Devices which use a 2.4 GHz radio wave frequency
  - Cordless phones
  - Cordless facsimiles
  - Microwave ovens
  - Wireless LAN devices (IEEE802.11b/g/n)
  - Wireless AV equipment
  - Wireless controllers for game systems
  - Microwave oven-based health aids

- Video transmitter
  - Specific type of external monitor and LCD display
2. Less common devices which use a 2.4 GHz radio wave frequency
    - Anti-theft systems
    - Amateur radio stations (HAM)
    - Warehouse logistic management systems
    - Discrimination systems for train or emergency vehicles

If these devices and the AV receiver are used at the same time, the audio may be undesirably stopped or disturbed due to a radio wave interference.

Suggestions for improvement

- Switch off the devices which emit the radio wave.
- Place the interfering devices away from the AV receiver.
- The AV receiver uses radio wave, and a third person can receive the wave on purpose or accidentally. Do not use the communication for important or fatal matters.
- We assume no responsibility whatsoever for any error or damage of network environment or access device resulting from the use of this apparatus. Confirm with the provider or access device maker for more information.

## Scope of Operation

Use of the AV receiver is limited to home use.

(Transmission distances may be reduced depending on communication environment.)

In the following locations, poor condition or inability to receive radio waves may cause the audio to be interrupted or stopped:

- In reinforced concrete buildings or steel framed or iron framed buildings.
- Near large metallic furniture.
- In a crowd of people or near a building or obstacle.
- In a location exposed to the magnetic field, static electricity or radio wave interference from radio communication equipment using the same frequency band (2.4 GHz) as the AV receiver, such as a 2.4 GHz wireless LAN device (IEEE802.11b/g/n) or microwave oven.

- If you live in a heavily populated residential area (apartment, townhouse, etc.) and if your neighbor's microwave oven is placed near your AV receiver, you may experience radio wave interference. If this occurs, move your AV receiver to a different place. When the microwave oven is not in use, there will be no radio wave interference.

## Radio Wave Reflections

The radio waves received by the AV receiver include the radio wave coming directly from the devices and waves coming from various directions due to reflections by walls, furniture and building (reflected waves). The reflected waves (due to obstacles and reflecting objects) further produce a variety of reflected waves as well as variation in reception condition depending on locations. If the audio cannot be received properly due to this phenomenon, try moving the location of the wireless LAN device a little. Also note that audio may be interrupted due to the reflected waves when a person crosses or approaches the space between the AV receiver and the wireless LAN device.

- We assume no responsibility whatsoever for any damages resulting from the use of this apparatus except in the cases deemed acceptable under the applicable laws and regulations.
- Operation in all environment is not guaranteed for wireless LAN. The communication may not be possible or have desirable communication speed.

## Precautions

- Do not use this apparatus near an electronic device handling high-accuracy controls or weak signals. Doing so may cause an accident due to a malfunction of the device.
- Do not use this apparatus in use prohibited location such as an aircraft equipment or a hospital. Doing so may cause an accident due to a malfunction of an electronic device or an electro-medical apparatus. Follow the instructions of the medical facilities.

### ■ Electronic device which requires cautions

Hearing aid, pace maker, other medical electronic devices,



fire alarm, automatic door, and other automatic control device.

When using a pace maker or other medical electronic

- devices, confirm with the medical electronic device
- maker or dealer for the effect of the radio wave.

The AV receiver contains a microPC for signal processing and control functions. In very rare situations, severe interference, noise from an external source, or static electricity may cause it to lockup. In the unlikely event that this happens, unplug the power cord from the wall outlet, wait at least 5 seconds, and then plug it back in.

Onkyo is not responsible for damages (such as CD rental fees) due to unsuccessful recordings caused by the unit's malfunction.

Before you record important data, make sure that the material will be recorded correctly.

Before disconnecting the power cord from the wall outlet, set the AV receiver to standby.

## Regarding the Video Resolution

The following shows how video signals at different resolutions are output by the unit.

Describes as follows as "Input: Output".

### ■ HDMI: HDMI

4K (\*2): 4K (\*1/\*3/\*4)

1080p/24: 4K (\*1), 1080p/24 (\*3)

1080p: 4K (\*1), 1080p (\*3)

1080i: 4K (\*1), 1080p, 1080i (\*3), 720p

720p: 4K (\*1), 1080p, 1080i, 720p (\*3)

480p/576p: 4K (\*1), 1080p, 1080i, 720p, 480p/576p (\*3)

480i/576i: 4K (\*1), 1080p, 1080i, 720p, 480p/576p,

480i/576i (\*3)

### ■ Component: HDMI

480i/576i: 4K (\*1), 1080p, 1080i, 720p, 480p/576p,

480i/576i (\*3)

### ■ Composite: HDMI

480i/576i: 4K (\*1), 1080p, 1080i, 720p, 480p/576p,

480i/576i (\*3)

### ■ HDMI: Component

Can not be output.

### ■ Component: Component

1080p: 1080p

1080i: 1080i

720p: 720p

480p/576p: 480p/576p

480i/576i: 480i/576i

### ■ Composite: Composite

480i/576i: 480i/576i

- \*1 Supported resolutions: [3840 × 2160 30 Hz], [3840 × 2160 25 Hz], [3840 × 2160 24 Hz], [4096 × 2160 24 Hz]
- \*2 The unit is compatible with HDMI IN 1 to HDMI IN 4. However, the number of the player that outputs video signal at 4K resolution or the same level at the same time may be up to three.
- \*3 Supported resolutions for HDMI OUT SUB.
- \*4 Supported resolutions: [3840 × 2160 60 Hz], [4096 × 2160 60 Hz], [3840 × 2160 50 Hz] and [4096 × 2160 50 Hz] in YCbCr4:2:0 compliant with HDMI2.0

## Reference Information

### Linked Operation with CEC-compatible Components

The AV receiver is compatible with the following components (as of January 2014).

#### TV (Random order):

- Toshiba TV sets
- Sharp TV sets

#### Players/Recorders (Random order):

- Onkyo and Integra RIHD-compatible players
- Toshiba players and recorders
- Sharp players and recorders (only when used together with Sharp TV sets)

Models other than those mentioned above may have some interoperability if compatible with CEC, which is part of the HDMI Standard, but operation can not be guaranteed.

**Note:** For RI functions to work properly, do not connect more RIHD-compatible components than the quantities specified below, to the HDMI jack. RI functions are not guaranteed when more RIHD-compatible components than the below mentioned quantities are connected. Furthermore, do not connect the AV receiver to another AV receiver/AV amplifier via HDMI.

- Blu-ray Disc/DVD players: up to 3.
- Blu-ray Disc/DVD recorders: up to 3.
- Cable TV tuner, terrestrial digital tuner, and satellite broadcasting tuner: up to 4 units.

### Checking whether the HDMI Linked Operation Settings Are Enabled

1. Turn on the power of all connected components.
2. Turn off the power of the TV, and confirm that the power of the connected components is turned off automatically with the link operation.
3. Turn on the power of the Blu-ray Disc/DVD player/recorder.
4. Start playback on the Blu-ray Disc/DVD player/recorder, and verify the following:
  - The AV receiver automatically turns on, and selects the input to which the Blu-ray Disc/DVD player/recorder is connected.
  - The TV automatically turns on, and selects the input to which the AV receiver is connected.
5. Following the operating instructions of the TV, select "Use the TV speakers" from the menu screen of the TV, and confirm that the audio is output from the speakers of the TV, and not from the speakers connected to the AV receiver.
6. Select "Use the speakers connected from the AV receiver" from the menu screen of the TV, and confirm that the audio is output from the speakers connected to the AV receiver, and not from the TV speakers.

#### Note:

- Even if you set to output audio on the TV speakers, audio will be output from the speakers connected to the AV receiver when you adjust the volume or switch the input on the AV receiver. To output audio from the TV speakers, redo the corresponding operations on the TV.
- In case of an RIHD connection with RI and RI audio control compatible components, do not connect the RI cable at the same time.
- On the TV, when you select anything other than the HDMI jack to which the AV receiver is connected, the input on the AV receiver will be switched to "TV/CD".
- The AV receiver will automatically power on in conjunction when it determines it to be necessary. Even if the AV receiver is connected to an RIHD compatible TV or player/recorder, it will not power on if it is not necessary. It may not power on in conjunction when the TV is set to output audio from the TV.
- Linked system functions with the AV receiver may not work depending on the component model connected. In such cases, operate the AV receiver directly.

- When the player/recorder cannot be operated with the remote controller of the AV receiver, the corresponding component may not be programmed to support the remote controller operation of CEC. Program the remote control code of the component maker to the remote controller for using.

### About HDMI

HDMI (High Definition Multimedia Interface) is a digital interface standard for connecting TVs, projectors, Blu-ray Disc/DVD players, set-top boxes, and other video components. Until now, several separate video and audio cables have been required to connect AV components. With HDMI, a single cable can carry control signals, digital video, and digital audio (2-channel PCM, multichannel digital audio, and multichannel PCM).

The HDMI video stream (i.e., video signal) is compatible with DVI (Digital Visual Interface) (\*1), so TVs and displays with a DVI input can be connected by using an HDMI-to-DVI adapter cable. (This may not work with some TVs and displays, resulting in no picture.)

This unit supports HDCP (High-bandwidth Digital Content Protection) (\*2), so it can display picture only on HDCP-compatible components.

The HDMI on this unit supports the following functions: Audio Return Channel, 3D, x.v.Color, DeepColor, Lip Sync, 4K (Passthrough), DTS-HD Master Audio, DTS-HD High Resolution Audio, Dolby TrueHD, Dolby Digital Plus, DSD and Multichannel PCM.

#### Supported Audio Formats of this Unit:

- 2-channel linear PCM (32 - 192 kHz, 16/20/24 bit)
- Multichannel linear PCM (up to 7.1 ch, 32 - 192 kHz, 16/20/24 bit)
- Bitstream (DSD, Dolby Digital, Dolby Digital Plus, Dolby TrueHD, DTS, DTS-HD High Resolution Audio, DTS-HD Master Audio)

Your Blu-ray Disc/DVD player must also support HDMI output of the above audio formats.

**About Copyright Protection:**

The HDMI jack of this unit is compliant with Revisions 1.4 and 2.2 (HDMI OUT MAIN and HDMI IN3 jacks only) of the HDCP (High-bandwidth Digital Content Protection) specification (\*2), which is a copy-protection system for digital video signals.

Other devices connected to this unit via HDMI must also be compliant with HDCP.

- \*1 DVI (Digital Visual Interface): The digital display interface standard set by the DDWG (\*3) in 1999.
- \*2 HDCP (High-bandwidth Digital Content Protection): The video encryption technology developed by Intel for HDMI/DVI. It is designed to protect video content and requires a HDCP-compatible HDMI/DVI receiver to display the encrypted video.
- \*3 DDWG (Digital Display Working Group): Led by Intel, Compaq, Fujitsu, Hewlett-Packard, IBM, NEC, and Silicon Image, this open industry group's objective is to address the industry's requirements for a digital connectivity specification for high-performance PC and digital displays.

**Note:**

- Some contents are only available for devices compliant with HDCP Rev. 2.2.  
To view and listen to this kind of content, connect the TV or player compliant with the HDCP Rev. 2.2 specification to the HDMI OUT MAIN and HDMI IN3 jacks of this unit.
- The HDMI video stream (i.e., video signal) is compatible with DVI (Digital Visual Interface), so TVs and displays with a DVI input can be connected by using an HDMI-to-DVI adapter cable. (Note that DVI connections only carry video, so you will need to make a separate connection for audio.) However, reliable operation with such an adapter is not guaranteed. In addition, video signals from a PC are not supported.
- The HDMI audio signal (sampling rate, bit length, etc.) may be restricted by the connected source component. If the picture is poor or there is no sound from a component connected via HDMI, check its setup. Refer to the connected component's instruction manual for details.

**Home network (LAN)**

The connection of several components via cables enabling the mutual communication is called a network.

At households, many families create (generally, the term "build" is used) a network to connect PC and gaming machines to the Internet and to exchange data between PC.

The network established in a relatively narrow area such as one household is called a LAN (Local Area Network).

In this manual, a term "home network" (network for a family) is used instead of "LAN," so this LAN becomes more familiar.

By connecting this unit with the network server such as a PC, playing music files in the network server (in the PC) is possible. Moreover, by connecting to the Internet, listening to the Internet radio is also possible.

This unit, PC, and Internet are not directly connected.

When connecting with a PC and/or Internet, several components (network components) are necessary.

**Components necessary for establishing a home network (LAN):**

Components necessary for the home network (LAN) for using the NET function of this unit are as follows.

**■ Router**

A router is a device that controls information (data) flow between the unit, PC, and the Internet.

As a network term, the flow of information (data) is called "traffic". The router has a role to control the information flow as the traffic control, between connected components.

- A router with a built-in 100Base-TX switch is recommended.  
In addition, if your router has the DHCP function, facilitating the network setting becomes possible.
- Some routers have a built-in modem, and some Internet Service Providers (ISP) require you to use specific routers.

Please consult your ISP or PC dealer if you are unsure.

**■ CAT5 Ethernet cable**

The Ethernet cable is a cable that actually connects components that comprise the network. There are straight type and cross type Ethernet cables.

- Use a shielded CAT5 Ethernet cable (straight-type) to connect the unit to your home network.

Consult your cable store for details of Ethernet cable.

**■ Network server****(When PC etc./network server is used)**

Component that stores music files and provides those files at the time of playback.

- Requirements for use with this unit depend on the component that is used as a network server.
- Conditions for pleasant playback of music files on the unit depend on the using network server (PC performance). See instruction manuals of using components.

**■ Modem (when Internet radio is used)**

Device that connects home network (LAN) and Internet

There are many kinds of modems depending on the forms of Internet connection.

In addition, when connecting to the Internet, it is required to conclude an agreement with a company that provides Internet connection service, called ISP (Internet Service Provider).

Use a modem that is recommended by your ISP company for the Internet connection.

There are some devices that have both router and modem functions.

Within above network components, prepare a router, Ethernet cable, and network server when the NET function "network server" is used.

For enjoying the NET function "Internet radio," it is necessary to use the router, Ethernet cable, and modem (and agreement with ISP).

## Server Requirements

### ■ Server playback

This unit can play digital music files stored on a PC or media server and supports the following technologies:

- Windows Media Player 11
- Windows Media Player 12
- DLNA-certified media server

The network server must be connected to the same network as this unit.

Up to 20,000 folders can be displayed, and folders may be nested up to 16 levels deep.

**Note:** Depending on the media server, the unit may not recognize it, or may not be able to play its music files.

### ■ Remote playback

Remote playback is the function that enables this unit to play music files saved in different components by operating the DLNA-compliant controller component and PC in the home network.

- Windows Media Player 12
- DLNA-certified (within DLNA Interoperability Guidelines version 1.5) media server or controller component.

\* The setting varies depending on the media server or controller components. Refer to your components' instruction manual for details.

If the operating system of your personal PC is Windows 8/Windows 7, Windows Media Player 12 is already installed. For more information, see the Microsoft web site.

## USB Storage Device Requirements

- USB mass storage device class (but not always guaranteed).
- FAT16 or FAT32 file system format.
- If the USB storage device has been partitioned, each section will be treated as an independent device.
- Up to 20,000 folders can be displayed, and folders may be nested up to 16 levels deep.
- USB hubs and USB storage devices with hub functions are not supported. Do not connect these devices to the unit.

### **Note:**

- If the media you connect is not supported, the message "No Storage" will be displayed.
- Sound files that are protected by copyright can not be played.
- When the USB audio player and this unit are connected, the audio player screen and the screen of the unit may be different. In addition, control functions of the audio player (classifying and sorting music files and adding information, etc.) are not available on this unit.
- Do not connect a PC to the USB port of the unit. Inputting sound to the USB port of the unit from a PC is not possible.
- Media inserted to the USB card reader may not be available in this function.
- Some USB storage devices and its contents may require some time to be read.
- Depending on the USB storage device, proper reading of the contents and proper supply of the power supply may not be possible.
- Onkyo accepts no responsibility whatsoever for the loss or damage to data stored on a USB storage device when that device is used with this unit. We recommend that you back up your important music files beforehand.
- Performance of the hard disk that receive power from the USB port of the unit is not guaranteed.
- If you connect a USB hard disk drive to the USB port of the unit, we recommend that you use its AC adapter to power it.
- When an audio player that are operated with batteries is used, make sure that the batteries have enough remaining power.
- USB storage devices with security functions can not be played.

## Supported Audio Formats

- For server playback and playback from a USB storage device, this unit supports the following music file formats.
- Music files of the following formats that can be played depend on the network server. For example, when using Windows Media Player 12, not all music files in the PC can be played. The music files that can be played are the ones registered to the Windows Media Player 12 library.
- Variable bit-rate (VBR) files are supported. However, playback times may not be displayed correctly.
- This unit supports the gapless playback of the USB storage device in the following conditions. When WAV, FLAC and Apple Lossless files are continuously played back with the same format, sampling frequency, channels and quantization bit rate.
- Remote playback does not support the gapless playback.

### **Note:**

- With remote playback, this unit does not support the following music file formats:
  - FLAC, Ogg Vorbis, DSD and Dolby TrueHD.

### ■ MP3 (.mp3 or .MP3)

- Supported formats: MPEG-1/MPEG-2 Audio Layer 3
- Supported sampling rates: 8 kHz, 11.025 kHz, 12 kHz, 16 kHz, 22.05 kHz, 24 kHz, 32 kHz, 44.1 kHz, 48 kHz
- Supported bitrates: Between 8 kbps and 320 kbps and VBR. Incompatible files can not be played.

### ■ WMA (.wma or .WMA)

**WMA stands for Windows Media Audio and is an audio compression technology developed by Microsoft Corporation. Audio can be encoded in WMA format by using Windows Media® Player.**

- WMA files must have the copyright option turned off.
- Supported sampling rates: 8 kHz, 11.025 kHz, 22.05 kHz, 32 kHz, 44.1 kHz, 48 kHz
- Supported bitrates: Between 5 kbps and 320 kbps and VBR. Incompatible files can not be played.
- WMA Pro/Voice formats are not supported.

### ■ WMA Lossless (.wma or .WMA)

- Supported sampling rates: 44.1 kHz, 48 kHz, 88.2 kHz, 96 kHz
- Quantization bit: 16 bit, 24 bit

### ■ WAV (.wav or .WAV)

WAV files contain uncompressed PCM digital audio.

- Supported sampling rates: 8 kHz, 11.025 kHz, 12 kHz, 16 kHz, 22.05 kHz, 24 kHz, 32 kHz, 44.1 kHz, 48 kHz, 64 kHz, 88.2 kHz, 96 kHz, 176.4 kHz and 192 kHz
- Quantization bit: 8 bit, 16 bit, 24 bit
- \* For playback from a USB storage device, sampling rates of 176.4 kHz and 192 kHz are not supported.

### ■ AAC

**(.aac/.m4a/.mp4/.3gp/.3g2/.AAC/.M4A/.MP4/.3GP or .3G2)**

- Supported formats: MPEG-2/MPEG-4 Audio
- Supported sampling rates: 8 kHz, 11.025 kHz, 12 kHz, 16 kHz, 22.05 kHz, 24 kHz, 32 kHz, 44.1 kHz, 48 kHz, 64 kHz, 88.2 kHz, 96 kHz
- Supported bitrates: Between 8 kbps and 320 kbps. Incompatible files can not be played.

### ■ FLAC (.flac or .FLAC)

**FLAC is a file format for lossless audio data compression.**

- Supported sampling rates: 8 kHz, 11.025 kHz, 12 kHz, 16 kHz, 22.05 kHz, 24 kHz, 32 kHz, 44.1 kHz, 48 kHz, 64 kHz, 88.2 kHz, 96 kHz, 176.4 kHz and 192 kHz
- Quantization bit: 8 bit, 16 bit, 24 bit
- \* For playback from a USB storage device, sampling rates of 176.4 kHz and 192 kHz are not supported.

### ■ Ogg Vorbis (.ogg or .OGG)

- Supported sampling rates: 8 kHz, 11.025 kHz, 16 kHz, 22.05 kHz, 32 kHz, 44.1 kHz, 48 kHz
- Supported bitrates: Between 32 kbps and 500 kbps and VBR.
- Incompatible files can not be played.

### ■ LPCM (Linear PCM)

- Supported sampling rates: 44.1 kHz, 48 kHz
- Quantization bit: 16 bit
- \* Only for playback via DLNA.

### ■ Apple Lossless (.m4a/.mp4/.M4A/.MP4)

- Supported sampling rates: 8 kHz, 11.025 kHz, 12 kHz, 16 kHz, 22.05 kHz, 24 kHz, 32 kHz, 44.1 kHz, 48 kHz, 64 kHz, 88.2 kHz, 96 kHz
- Quantization bit: 16 bit, 24 bit

### ■ DSD (.dsf or .DSF)

- Supported sampling rates: 2.8224 MHz, 5.6448 MHz
- \* For playback from a USB storage device, sampling rates of 5.6448 MHz is not supported.

### ■ Dolby TrueHD (.vr/.mlp/.VR/.MLP)

- Supported sampling rates: 48 kHz, 64 kHz, 88.2 kHz, 96 kHz, 176.4 kHz, 192 kHz
- \* For playback from a USB storage device, only sampling rates of 48 kHz is supported.

## Remote Control Code List

## ■ Television (A to E)

|                    |  |
|--------------------|--|
| A.R. Systems       | 10037, 10556   |
| Accent             | 10037  |
| Acoustic Solutions | 11667, 11585, 11037                                    |
| Action             | 10650  |
| Addison            | 10653, 11150   |
| AEG                | 11037  |
| Aiko               | 10037  |
| Aim                | 10037  |
| Akai               | 10037, 12676, 10208, 10714, 10556, 12414, 13183, 10178 |
| Akiba              | 10037  |
| Akito              | 10037  |
| Akura              | 10037, 10714, 11667, 11585, 10171, 11037               |
| Alba               | 11037, 12676, 10037, 10714, 11585                      |
| Alien              | 11037  |
| Allstar            | 10037  |
| Amstrad            | 10037, 10171, 11037                                    |
| Anam               | 10037, 10650   |
| Andersson          | 11585, 12676   |
| Anitech            | 10037  |
| Ansonic            | 10037  |
| AOC                | 11365, 12769, 10178, 10625, 11150                      |
| Apex Digital       | 12397  |
| Ardem              | 10714, 10037   |
| Arena              | 10037  |
| Ario               | 12397  |
| Aristona           | 10556, 10037   |
| ART                | 11037  |
| Art Mito           | 11585  |

|               |   |
|---------------|---|
| Asberg        | 10037   |
| Astra         | 10037   |
| ATD           | 10698   |
| Atlantic      | 10037   |
| Audiosonic    | 10714, 10037  |
| Audioworld    | 10698   |
| Autovox       | 12676   |
| Aventura      | 10171   |
| Axxon         | 10714   |
| Baird         | 10208   |
| Barco         | 10556   |
| Base          | 10698   |
| Basic Line    | 10037, 11037, 10556   |
| Baur          | 10037, 10195  |
| Beaumarck     | 10178   |
| Beijing       | 10208   |
| Beko          | 10714, 10037  |
| Bell & Howell | 10017   |
| Belson        | 10698   |
| Belstar       | 11037   |
| Beon          | 10037   |
| Berthen       | 10556   |
| Bestar        | 10037   |
| Bexa          | 12493   |
| BGH           | 12414   |
| Black Diamond | 11037   |
| Blaupunkt     | 10195   |
| Blue Sky      | 10714, 10037, 11037, 10556, 10625                             |
| BPL           | 10208, 10037  |
| Brandt        | 10625, 11585, 10714   |
| Brinkmann     | 10037   |
| Briovega      | 10037   |
| Britania      | 12414   |
| Bush          | 11037, 10037, 10714, 12676, 11667, 10208, 10556, 10698, 11585 |

|                      |                            |
|----------------------|----------------------------|
| Byd:sign             | 12209                      |
| Camper               | 10037                      |
| Carad                | 11037                      |
| Carena               | 10037                      |
| Carrefour            | 10037                      |
| Cascade              | 10037                      |
| Casio                | 10037                      |
| Cathay               | 10037                      |
| CCE                  | 13782, 10037               |
| Celcus               | 12676, 11585               |
| Celebrity            | 10000                      |
| Centrum              | 11037                      |
| Centurion            | 10037                      |
| Changhong            | 13434, 12769, 10508        |
| Chimei               | 12769                      |
| Chun Yun             | 10000, 11150               |
| Chung Hsin           | 11150                      |
| Clarivox             | 10037                      |
| Clatronic            | 10037, 10714               |
| Clayton              | 11037                      |
| Coby                 | 13478                      |
| Commercial Solutions | 11447                      |
| Condor               | 10037                      |
| Conrowa              | 10698                      |
| Contec               | 10037                      |
| Cosmel               | 10037                      |
| CPTEC                | 10625                      |
| Crown                | 10037, 10714, 10208, 11037 |
| Crypton              | 11667                      |
| Curtis               | 12397                      |
| Cyberpix             | 11667                      |
| D-Vision             | 10037, 10556               |
| Daewoo               | 10037, 10556, 10178, 11150 |
| Dansai               | 10037, 10208               |
| Dantax               | 11037, 10714, 12676        |
| Datsura              | 10208                      |
| Dawa                 | 10037                      |

|              |  |
|--------------|--|
| Daytron      | 10037                                    |
| De Graaf     | 10208                                    |
| Decca        | 10037                                    |
| Denver       | 10037                                    |
| Desmet       | 10037                                    |
| Diamant      | 10037                                    |
| Diamond      | 10698                                    |
| Digatron     | 10037                                    |
| Digihome     | 11667, 12676                             |
| Digiline     | 10037                                    |
| Digisonic    | 11826                                    |
| Digitor      | 10698, 10037                             |
| Dixi         | 10037                                    |
| Drean        | 10037                                    |
| DSE          | 10698                                    |
| Dual         | 11667, 10037, 11037, 11585, 12676, 10714 |
| Dumont       | 10017                                    |
| Durabrand    | 10171, 10178, 10714, 11037               |
| Dux          | 10037                                    |
| DX Antenna   | 13817                                    |
| Dynatron     | 10037                                    |
| Dynex        | 12049                                    |
| E.S.C.       | 10037                                    |
| ECE          | 10037                                    |
| Elbe         | 10037, 10556                             |
| Electroband  | 10000                                    |
| Electrograph | 11755                                    |
| Elektra      | 10017                                    |
| Elfunk       | 11037                                    |
| ELG          | 10037                                    |
| Elin         | 10037                                    |
| Elite        | 10037                                    |
| Emerson      | 11864, 10171, 11394, 10178, 10037, 10714 |
| Envision     | 11365, 11506                             |
| Epson        | 11379                                    |
| Erres        | 10037                                    |

|                    |       |
|--------------------|-------|
| ESA                | 10171 |
| Euroman            | 10037 |
| Europa             | 10037 |
| Europhon           | 10037 |
| Evesham Technology | 11667 |
| Excello            | 11037 |
| Exquisit           | 10037 |

#### ■ Television (F to J)

|                 |  |
|-----------------|--|
| F&U             | 12676  |
| FairTec         | 11585  |
| Ferguson        | 10625, 11037,<br>10037, 10195,<br>11585, 12676 |
| Fidelity        | 10037, 10171                                   |
| Finlandia       | 10208  |
| Finlux          | 11667, 10714,<br>12676, 10037,<br>10556        |
| Firstline       | 10714, 10037,<br>11037, 10208,<br>10556        |
| Fisher          | 10208  |
| Flint           | 10037  |
| Formenti        | 10037  |
| Fraba           | 10037  |
| Freesat         | 11636  |
| Friac           | 10037  |
| Frigidaire      | 11826  |
| Fujitsu         | 10809  |
| Fujitsu Siemens | 10809  |
| Funai           | 13817, 10171,<br>11394, 11037,<br>10714        |
| Gaba            | 11037  |
| Galaxi          | 10037  |
| Galaxis         | 10037  |
| Gateway         | 11755  |
| GE              | 11447, 10178,<br>10625, 11454                  |
| GEC             | 10037  |

|           |   |
|-----------|---|
| Genesis   | 10037   |
| Genexxa   | 10037   |
| GFM       | 10171, 11864  |
| Gibraltar | 10017   |
| Gibson    | 11826   |
| Gintai    | 11150   |
| Godrej    | 11585   |
| GoGen     | 12676   |
| GoldStar  | 10178, 10037,<br>10714, 11150                                   |
| Goodmans  | 10037, 11037,<br>11667, 10714,<br>11585, 10556,<br>10625, 12676 |
| Gorenje   | 11585, 12676  |
| Gradiente | 10037   |
| Graetz    | 10714   |
| Granada   | 10208, 10037  |
| Grandin   | 10037, 10714,<br>11037, 10556                                   |
| Grundig   | 10195, 11223,<br>10556, 10037,<br>11667, 12676                  |
| H-Buster  | 13620   |
| Haier     | 13620, 10698,<br>10037, 10508                                   |
| Hallmark  | 10178   |
| Hankook   | 10178   |
| Hannspree | 11826   |
| Hanseatic | 10037, 10714,<br>10625, 10556                                   |
| Hantarex  | 10037   |
| Hantor    | 10037   |
| Harwood   | 10037   |
| Hauppauge | 10037   |
| HB        | 10714   |
| HCM       | 10037   |
| Heran     | 11826   |
| Herosonic | 11826   |
| Highline  | 10037   |
| Hinari    | 10037, 10208  |
| HiPlus    | 11826   |

|                |   |
|----------------|---|
| Hisawa         | 10714   |
| Hisense        | 10556, 10508,<br>10208  |
| Hitachi        | 11643, 12676,<br>11576, 11585,<br>11691, 11037,<br>11667, 10037,<br>10150, 10178,<br>10508, 11150,<br>12170 |
| Hitachi Fujian | 10150   |
| Hitec          | 10698   |
| Hoher          | 10714   |
| Horniphon      | 10037   |
| Hua Tun        | 11150   |
| Hypson         | 10037, 10714,<br>10556, 11037   |
| Hyundai        | 10698, 12676,<br>11037  |
| Iberia         | 10037   |
| ICE            | 10037   |
| iLo            | 11394   |
| Imperial       | 10037   |
| Indiana        | 10037   |
| Inno Hit       | 11037, 11585  |
| Innova         | 10037   |
| Insignia       | 12049, 10171  |
| Integra        | 11807, 13100,<br>13500  |
| Inteq          | 10017   |
| Interbuy       | 10037   |
| Interfunk      | 10037   |
| Internal       | 10556   |
| Intervision    | 10037   |
| Irradio        | 10037   |
| IRT            | 10698   |
| Isis           | 12676   |
| Isukai         | 10037   |
| ITS            | 10037   |
| ITT            | 12676, 10208  |
| ITT Nokia      | 10208   |
| ITV            | 10037   |

|         |   |
|---------|---|
| JCB     | 10000   |
| Jinfeng | 10208   |
| Jinxing | 10037, 10556,<br>10698  |
| JMB     | 12676, 10556  |
| Jubilee | 10556   |
| JVC     | 11774, 10653,<br>11601, 12271,<br>11428, 10508,<br>10650, 12676 |

#### ■ Television (K to N)

|                |                               |
|----------------|-------------------------------|
| Kaisui         | 10037                         |
| Karcher        | 10714                         |
| Kathrein       | 10556                         |
| Kendo          | 11037, 11585,<br>12676, 10037 |
| Kennex         | 11037                         |
| Kioto          | 10556                         |
| Kiton          | 10037                         |
| KLL            | 10037                         |
| Kneissel       | 10037, 10556                  |
| Kolin          | 10150, 10037,<br>11150, 11755 |
| Kolster        | 10037                         |
| Konka          | 10037, 10714                  |
| Konnig         | 10037                         |
| Korpel         | 10037                         |
| Kosmos         | 10037                         |
| Kunlun         | 10208                         |
| Kupperbusch    | 12676                         |
| L&S Electronic | 10714                         |
| Lavis          | 11037                         |
| Leicon         | 10037                         |
| Lenco          | 10037, 11037                  |
| Leyco          | 10037                         |

|                      |  |
|----------------------|--|
| LG                   | 11840, 11860, 11423, 12731, 12182, 12358, 12362, 10178, 12424, 10037, 10714, 10017, 10556, 10698 |
| LiesenKotter         | 10037  |
| Lifetec              | 10037, 11037, 10714  |
| Linetech             | 12676  |
| Linsar               | 12676, 11667, 11585  |
| Local India Brand    | 10208  |
| Local Malaysia Brand | 10698  |
| Lodos                | 11037  |
| Loewe                | 10633  |
| Logik                | 11037, 10698, 11585  |
| Luma                 | 11037  |
| Lumatron             | 10037  |
| Lumenio              | 10037  |
| Lux May              | 10037  |
| Luxor                | 11037, 12676, 10208  |
| LXI                  | 10178  |
| Madison              | 10037  |
| Magnavox             | 12372, 11454, 11506, 10171, 11365, 11755, 11867  |
| Magnum               | 10714, 10037   |
| Manesth              | 10037  |
| Manhattan            | 10037, 11037   |
| Marantz              | 10037, 10556   |
| Mark                 | 10037, 10714   |
| Mastro               | 10698  |
| Masuda               | 10037  |
| Matsui               | 10037, 10195, 10208, 11037, 10714, 10556, 11667, 12676   |
| Matsushita           | 10650  |

|                   |   |
|-------------------|---|
| Maxent            | 11755   |
| Maxess            | 12493   |
| Meck              | 10698   |
| Mediator          | 10037, 10556  |
| Medion            | 10714, 10037, 11037, 12676, 11667, 10556, 10698, 11585        |
| Megatron          | 10178   |
| MEI               | 11037   |
| Melectronic       | 10037, 10195, 10714   |
| Memorex           | 10178, 10150, 11037   |
| Mercury           | 10037   |
| Mermaid           | 10037   |
| Metronic          | 10625   |
| Metz              | 11037, 10195  |
| MGA               | 10150, 10178  |
| Micromaxx         | 10037, 10714, 11037   |
| Midland           | 10017   |
| Mikomi            | 11585, 11667  |
| Minato            | 10037   |
| Minerva           | 10195   |
| Ministry Of Sound | 11667   |
| Minoka            | 10037   |
| Mitsubishi        | 10150, 11250, 12313, 10178, 10037, 10556, 11150, 11037, 11171 |
| Moree             | 10037   |
| Morgan's          | 10037   |
| Moserbaer         | 11585   |
| MTlogic           | 10714   |
| Mudan             | 10208   |
| Multitec          | 11037, 10037  |
| Multitech         | 10037   |
| Myryad            | 10556   |
| NAD               | 10037, 10178  |
| Naiko             | 10037   |

|            |                                   |
|------------|-----------------------------------|
| Nakimura   | 10037                             |
| National   | 10208, 10508                      |
| NEC        | 12461, 10178, 10508, 10653, 11150 |
| Neckermann | 10037, 10556                      |
| NEI        | 10037, 11037                      |
| Neoka      | 11826                             |
| Netsat     | 10037                             |
| NetTV      | 11755                             |
| Neufunk    | 10556, 10714, 10037               |
| Nevir      | 12676                             |
| New Sonic  | 11826                             |
| New Tech   | 10037, 10556                      |
| Newave     | 10178, 11150                      |
| Nikkai     | 10037                             |
| Nikkei     | 10714                             |
| Nikko      | 10178                             |
| Nokia      | 10208                             |
| Norcent    | 11365                             |
| Nordmende  | 10195, 11585, 10037, 10714, 11667 |
| Normerel   | 10037                             |
| Novatron   | 10037                             |
| Novita     | 11585                             |
| NPG        | 13434                             |

#### ■ Television (O to S)

|         |                            |
|---------|----------------------------|
| Oceanic | 10208                      |
| OK Line | 11037                      |
| OK.     | 13434, 12676               |
| Okano   | 10037                      |
| OKI     | 11667, 12676, 13434, 11585 |
| Omni    | 10698                      |
| Onei    | 11667                      |
| Onida   | 10653, 12414               |
| Onimax  | 10714                      |
| Onix    | 10698                      |

|              |  |
|--------------|--|
| Onkyo        | 11807, 13100, 13500  |
| Onn          | 11667  |
| Opera        | 10037, 10714   |
| Optimus      | 10650  |
| Orava        | 11037  |
| Orbit        | 10037  |
| Orion        | 10037, 10556, 10714, 11037, 12676                                    |
| Orline       | 10037  |
| Ormond       | 11037  |
| Osaki        | 10037, 10556   |
| Osio         | 10037  |
| Osume        | 10037  |
| Otto Versand | 10037, 10556, 10195  |
| Pacific      | 10714, 11037, 10556  |
| Palladium    | 10037, 10714, 10556  |
| Palsonic     | 12461, 10698, 10037  |
| Panama       | 10037  |
| Panasonic    | 11636, 11291, 11480, 11650, 10650, 13825, 12170, 10037, 10208, 10508 |
| Panavideo    | 13825  |
| Panavision   | 10037  |
| Panda        | 10208, 10508, 10698  |
| Penney       | 10178  |
| Perdio       | 10037  |
| Perfekt      | 10037  |
| Philco       | 13426, 12414, 10037, 10178   |



|              |   |
|--------------|---|
| Philips      | 10037, 12800, 10556, 11887, 11867, 11506, 12372, 12680, 11454, 10171, 11365, 10017, 10000, 10178, 11394 |
| Phocus       | 10714   |
| Phoenix      | 10037   |
| Phonola      | 10037, 10556  |
| Pioneer      | 11457, 10037, 10698, 11636, 12171   |
| PJ           | 11506   |
| Plantron     | 10037   |
| Playsonic    | 10714, 10037  |
| Polaroid     | 12676, 11826  |
| Powerpoint   | 10037, 10698  |
| Prima        | 12461   |
| Prinston     | 11037   |
| Pro Vision   | 10037, 10556, 10714   |
| Profitronic  | 10037   |
| Proline      | 10625, 10037, 11037, 12676  |
| Proscan      | 11447   |
| Prosonic     | 10714, 12676, 10037, 11585, 11667   |
| Protech      | 10037, 11037  |
| Proton       | 10178   |
| Pulsar       | 10017   |
| Pye          | 10037, 10556  |
| Qingdao      | 10208   |
| Quadro       | 11667   |
| Quasar       | 11291, 10650  |
| Quelle       | 10037, 11037, 10195   |
| R-Line       | 10037   |
| Radiola      | 10037, 10556  |
| Radiomarelli | 10037   |

|            |  |
|------------|--|
| RadioShack | 10037, 10178   |
| Radiotone  | 10037, 11037   |
| RCA        | 11447, 12746, 10625, 12434, 12932, 12187, 10000, 10178, 10618, 11454, 13426        |
| Realistic  | 10178  |
| Recor      | 10037  |
| Rectiligne | 10037  |
| Red Star   | 10037  |
| Reflex     | 10037, 11037   |
| Relisys    | 11585  |
| Relon      | 11826  |
| Remotec    | 10037, 10171   |
| Reoc       | 10714  |
| Revox      | 10037  |
| RFT        | 10037  |
| Roadstar   | 11037, 10037, 10714  |
| Rowa       | 10698, 10037   |
| Runco      | 10017  |
| Saba       | 10625, 10714, 12676  |
| Sagem      | 10618  |
| Saivod     | 11037, 10037   |
| Salora     | 10208  |
| Sampo      | 11755, 10171, 10178, 10650   |
| Samsung    | 12051, 11632, 10618, 10037, 10556, 10178, 10208, 11150                             |
| Sansui     | 10037, 10714   |
| Sanyo      | 10208, 11142, 11585, 12676, 12461, 11974, 12769, 10508, 11037, 11150, 11365, 11667 |
| SBR        | 10037, 10556   |

|                 |  |
|-----------------|--|
| Schaub Lorenz   | 10714, 12676, 11667                                    |
| Schneider       | 10037, 10556, 10714, 11037, 11585, 12676               |
| Schontech       | 11037  |
| Scotch          | 10178  |
| Scott           | 10178  |
| Sears           | 10171, 10178   |
| Seelver         | 11037  |
| SEG             | 11037, 10037, 13434                                    |
| SEI             | 10037  |
| Sei-Sinudyne    | 10037  |
| Semp Toshiba    | 13793  |
| Sencor          | 10714  |
| Senzu           | 12493  |
| Serie Dorada    | 10178  |
| Shanghai        | 10208  |
| Sharp           | 11659, 12360, 10818, 11393, 12676, 10650, 11165, 11423 |
| Sheng Chia      | 11150  |
| Shintoshi       | 10037  |
| Shivaki         | 10178, 10037   |
| Siam            | 10037  |
| Siemens         | 10195, 10037   |
| Siera           | 10556, 10037   |
| Silva           | 10037  |
| Silva Schneider | 10037  |
| SilverCrest     | 12676, 11037   |
| Sinudyne        | 10037  |
| SKY             | 10037  |
| Skyworth        | 12769, 10037, 10698                                    |
| Solavox         | 10037  |
| Soniko          | 10037  |
| Soniq           | 12493  |
| Sonitron        | 10208  |
| Sonneclair      | 10037  |
| Sonoko          | 10037  |

|             |   |
|-------------|---|
| Sonorol     | 10208   |
| Sontec      | 10037   |
| Sony        | 12778, 11825, 10810, 10000, 11651, 11505, 11167 |
| Soundesign  | 10178   |
| Soundwave   | 10037, 11037                                    |
| Sowa        | 10178, 11150                                    |
| Soyea       | 10698   |
| Soyo        | 11826   |
| Squareview  | 10171   |
| SR Standard | 10037, 11037                                    |
| Starlite    | 10037   |
| STI         | 13793   |
| Strato      | 10037   |
| Sunny       | 10037   |
| Sunstar     | 10037   |
| Sunstech    | 12676   |
| Sunwood     | 10037   |
| Supersonic  | 10208   |
| SuperTech   | 10037, 10556                                    |
| Supra       | 10178   |
| Supreme     | 10000   |
| Svasa       | 10208   |
| Sylvania    | 10171, 11864, 11394                             |
| Symphonic   | 10171, 11394                                    |
| Synco       | 11755, 10000, 10178, 11826                      |
| Sysline     | 10037   |

### ■ Television (T to Z)

|             |   |
|-------------|---|
| Tacico      | 10178, 11150  |
| Tai Yi      | 11150   |
| Talent      | 10178   |
| Tashiko     | 10650, 11150  |
| Tatung      | 10037, 11150  |
| TCL         | 12434, 13183,<br>13426, 12414,<br>10698                         |
| TCM         | 10714   |
| Teac        | 10037, 11037,<br>10698, 10714,<br>11755, 10171,<br>10178        |
| Tec         | 10037   |
| Tech Line   | 10037, 11585  |
| Technica    | 11037   |
| Technics    | 10556, 10650  |
| Technika    | 11667, 12676  |
| TechniSat   | 10556   |
| Technisson  | 10714   |
| Techno      | 11585   |
| Technosonic | 10556, 10625  |
| Techwood    | 11667, 11037,<br>12676  |
| Tecnimagen  | 10556   |
| Teco        | 10178, 10653  |
| Tedelex     | 10208   |
| Teknika     | 10150   |
| TELE System | 11585   |
| Telecor     | 10037   |
| Telefunken  | 10625, 12676,<br>12414, 10698,<br>11585, 10037,<br>10714, 11667 |
| Telefusion  | 10037   |
| Telegazi    | 10037   |
| Telemeister | 10037   |
| Telesonic   | 10037   |
| Telestar    | 10037, 10556  |
| Teletech    | 10037, 11037  |
| Television  | 10037   |

|                    |   |
|--------------------|---|
| Tennessee          | 10037   |
| Tensai             | 10037, 11037  |
| Terris             | 11667   |
| Tesla              | 11037, 10037,<br>10556, 10714   |
| Tevion             | 10714, 11037,<br>10037, 10556,<br>11585, 11667  |
| Thomson            | 10625, 11447,<br>10037  |
| Thorn              | 10037   |
| TMK                | 10178   |
| TNCi               | 10017   |
| Tokai              | 10037, 11037  |
| Tokaido            | 11037   |
| Topline            | 11037   |
| Toshiba            | 11508, 11524,<br>11656, 12676,<br>10508, 13570,<br>10650, 11037,<br>10195, 10618,<br>11150, 11169 |
| TRANS-continentals | 10037, 10556,<br>11037  |
| Transonic          | 10037, 10698  |
| Triad              | 10556   |
| Triumph            | 10037, 10556  |
| TVTEXT 95          | 10556   |
| Uher               | 10037   |
| Ultravox           | 10037   |
| Unic Line          | 10037   |
| Uniden             | 12122, 12676,<br>11667  |
| United             | 10714, 11037,<br>10037, 10556   |
| Universal          | 10037, 10714  |
| Universum          | 10037, 11037,<br>10195, 10618   |
| Univox             | 10037   |
| V7 Videoseven      | 11755   |
| Vestel             | 11037, 10037,<br>11585, 11667   |

|                    |                               |
|--------------------|-------------------------------|
| Vexa               | 10037                         |
| Victor             | 11428, 10650,<br>10653        |
| Videocon           | 10508, 10037                  |
| VideoSystem        | 10037                         |
| Vidtech            | 10178                         |
| Viewsonic          | 11755, 12049,<br>11365        |
| Vision             | 11826, 10037                  |
| VIZIO              | 11758, 13758,<br>12209        |
| Vortec             | 10037                         |
| Voxson             | 10037, 10178,<br>11667        |
| VU                 | 11365                         |
| Walker             | 12676, 11667,<br>11585        |
| Waltham            | 10037, 11037                  |
| Wards              | 10017, 10000,<br>10178        |
| Watson             | 11037, 10037,<br>10714        |
| Wega               | 10037                         |
| Welltech           | 10714                         |
| Weltstar           | 11037                         |
| Westinghouse       | 11712, 11826,<br>11755, 12397 |
| Westwood           | 11585                         |
| Wharfedale         | 11667, 10037,<br>10556        |
| White Westinghouse | 10037                         |
| Wilson             | 10556                         |
| Windsor            | 11037                         |
| Windy Sam          | 10556                         |
| Wintel             | 10714                         |
| Wyse               | 11365                         |
| Xiahua             | 10698                         |
| Xiron              | 11037                         |
| XLogic             | 10698                         |
| Xoceco             | 10037, 12461                  |
| Xrypton            | 10037                         |
| Yamaha             | 11576, 10650                  |

|          |  |
|----------|--|
| Yamishi  | 10037  |
| Yokan    | 10037  |
| Yoko     | 10037  |
| YU-MA-TU | 10037  |
| Zenith   | 10017, 10178,<br>11423, 12731,<br>11365, 12358,<br>12362 |
| Zepto    | 11585  |
| Zonda    | 10698  |

### ■ TV DVD Combination

|               |   |
|---------------|---|
| Akai          | 12676, 32966                            |
| Alba          | 12676, 32966                            |
| Black Diamond | 11037, 30713                            |
| Blue Sky      | 11037, 30713                            |
| Bush          | 12676, 10698,<br>11037, 30713,<br>32966 |
| Centrum       | 11037, 30713                            |
| Crown         | 11037, 30713                            |
| Dual          | 11037, 30713                            |
| Dynex         | 12049                                   |
| Elfunk        | 11037, 30713                            |
| Emerson       | 11864, 11394,<br>30675                  |
| Ferguson      | 11037, 30713                            |
| Funai         | 11394, 30675                            |
| Goodmans      | 11037, 12676,<br>30713, 32966           |
| Grandin       | 30713                                   |
| Grundig       | 30539                                   |
| Hitachi       | 12676, 11037,<br>30713, 32966           |
| Insignia      | 12049                                   |
| JVC           | 12271, 11774                            |
| LG            | 11423                                   |
| Linsar        | 12676, 32966                            |
| Logik         | 11037, 30713                            |
| Luxor         | 11037, 30713                            |
| Magnavox      | 12372                                   |

|              |                                   |
|--------------|-----------------------------------|
| Matsui       | 11037, 12676, 30713               |
| Medion       | 12676, 32966                      |
| Mitsubishi   | 34004                             |
| OK.          | 13434                             |
| OKI          | 12676, 32966                      |
| Orava        | 11037, 30713                      |
| Panasonic    | 12170                             |
| Philips      | 10556, 11454, 11394, 12372, 30539 |
| Polaroid     | 12676, 32966                      |
| Powerpoint   | 10698                             |
| Prosonic     | 12676, 32966                      |
| RCA          | 12187, 12746, 12932, 11447        |
| Samsung      | 12051                             |
| Sanyo        | 12676                             |
| SEG          | 11037, 30713                      |
| Sharp        | 10818, 12360, 12676, 32966        |
| Soniq        | 12493                             |
| Sony         | 12778                             |
| Sylvania     | 11864, 11394, 10171, 30675, 30630 |
| Teac         | 10698                             |
| Technica     | 11037, 30713                      |
| Telefunken   | 10698                             |
| Teletech     | 11037, 30713                      |
| Thomson      | 10625, 30551                      |
| Toshiba      | 11524, 12676, 32966               |
| United       | 11037, 30713                      |
| Universum    | 30713                             |
| Vestel       | 11037                             |
| Viewsonic    | 12049                             |
| Weltstar     | 11037, 30713                      |
| Westinghouse | 11712                             |
| Xiron        | 11037, 30713                      |

### ■ DVD

|                    |                            |
|--------------------|----------------------------|
| 3D LAB             | 30539                      |
| Accurian           | 30675                      |
| Acoustic Solutions | 30730, 30713               |
| AEG                | 30675, 30770, 31233        |
| Aiwa               | 30533                      |
| Akai               | 32966, 31233, 30675, 30770 |
| Akura              | 31233                      |
| Alba               | 32966, 30713, 30730, 30539 |
| Amitech            | 30770                      |
| Amstrad            | 30713, 30770, 32139        |
| AMW                | 30872                      |
| Ansonic            | 30831                      |
| Aristona           | 30539, 30646               |
| ASDA               | 32213                      |
| Audix              | 30713                      |
| Autovox            | 30713                      |
| Awa                | 30730, 30872               |
| Axion              | 30730                      |
| Basic Line         | 30713                      |
| Bel Canto Design   | 31571                      |
| Belson             | 32139                      |
| Best Buy           | 32139                      |
| Black Diamond      | 30713                      |
| Blu:sens           | 31233                      |
| Blue Parade        | 30571                      |
| Blue Sky           | 30713                      |
| Brainwave          | 30770                      |
| Brandt             | 30551, 30503               |
| Bush               | 30713, 30730, 30831, 32966 |
| Byd:sign           | 30872                      |
| CCE                | 30730                      |
| Celcus             | 32966                      |
| Centrum            | 30713, 30675               |
| Changhong          | 30627                      |
| Cinea              | 30831                      |

|                    |                                   |
|--------------------|-----------------------------------|
| Cineral            | 30730                             |
| Cinetec            | 30713, 30872                      |
| Classic            | 30730                             |
| Clatronic          | 30675, 31233                      |
| Clayton            | 30713                             |
| Coby               | 30730                             |
| Codex              | 31233                             |
| Continental Edison | 30831, 30872                      |
| Craig              | 30831                             |
| Crown              | 30713, 30770                      |
| Cybercom           | 30831                             |
| Daenyx             | 30872                             |
| Daewoo             | 30770, 30872                      |
| Dansai             | 30770                             |
| Dantax             | 30713, 30539, 32966               |
| Datsun             | 31233                             |
| Daytek             | 30872                             |
| Dayton Audio       | 30872                             |
| DCE                | 30831                             |
| Decca              | 30770                             |
| Denon              | 31634, 32258, 32748, 30490, 33851 |
| Dewo               | 31634                             |
| Digihome           | 30713, 32966                      |
| DigiLogic          | 30713                             |
| DiK                | 30831                             |
| Disney             | 30675, 30831                      |
| DK Digital         | 30831                             |
| Dragon             | 30831                             |
| DSE                | 30675                             |
| Dual               | 30831, 30713, 30730, 32966        |
| Durabrand          | 30675, 30713, 30831               |
| Dynex              | 32596                             |
| E:max              | 30770, 31233                      |
| ECC                | 30730                             |
| Elfunk             | 30713                             |
| Elin               | 30770                             |

|                  |                            |
|------------------|----------------------------|
| Elite            | 32854                      |
| Elta             | 30770, 31233               |
| Eltax            | 31233                      |
| Emerson          | 30675, 32213               |
| EuroLine         | 30675, 31233               |
| Ferguson         | 30713, 32966               |
| Finlux           | 32966, 30770, 30741        |
| Firstline        | 30713                      |
| Funai            | 30675                      |
| G-Hanz           | 32213                      |
| G-HanzS          | 32213                      |
| GE               | 30522                      |
| GFM              | 30675                      |
| Go Video         | 31044, 30741               |
| GoldStar         | 30741                      |
| Goodmans         | 30713, 30730, 32966        |
| GPX              | 30741                      |
| Gran Prix        | 30831                      |
| Grandin          | 30713, 31233               |
| Grundig          | 30539, 30551, 30713, 32966 |
| Grunkel          | 30770, 30831               |
| GVG              | 30770                      |
| H & B            | 30713, 31233               |
| Hanseatic        | 30741                      |
| Harman/Kardon    | 30582                      |
| HE               | 30730                      |
| Hello Kitty      | 30831                      |
| Henss            | 30713                      |
| Hitachi          | 32966, 30573, 30713, 31664 |
| Hoher            | 30713, 30831               |
| Home Electronics | 30730, 30770               |
| Humax            | 30646                      |
| HYD              | 31233                      |
| Hyundai          | 32966                      |
| Inno Hit         | 30713                      |
| Insignia         | 32596, 30675, 30741        |

|                     |  |
|---------------------|--|
| Integra             | 32147, 30627,<br>31769, 30503,<br>31612, 30571,<br>31634 |
| Irradio             | 31233, 30646   |
| ITT                 | 31233  |
| JDB                 | 30730  |
| JMB                 | 32966  |
| JVC                 | 30623, 31602,<br>30503, 30539,<br>32966                  |
| Kansas Technologies | 31233  |
| Kendo               | 30713, 30831   |
| Kennex              | 30713, 30770   |
| Kenwood             | 30490  |
| Kihiro              | 30770  |
| Kupperbusch         | 32966  |
| Leiker              | 30872  |
| Lenco               | 30713, 30770   |
| Lexicon             | 32545  |
| LG                  | 30741, 31602,<br>31233                                   |
| Lifetec             | 30831  |
| Linetech            | 32966  |
| Linsar              | 32966  |
| Lodos               | 30713  |
| Loewe               | 30741, 30539   |
| Logik               | 30713  |
| Lumatron            | 30713, 30741   |
| Lunatron            | 30741  |
| Luxman              | 30573  |
| Luxor               | 30713, 32966   |
| Magnavox            | 30675, 30503,<br>30646, 30539,<br>31354, 30713           |
| Manhattan           | 30713  |
| Marantz             | 30539, 32414,<br>33444                                   |
| Mark                | 30713  |
| Marquant            | 30770  |
| Matsui              | 30713, 32966   |
| Maxim               | 30713, 30872   |

|              |  |
|--------------|--|
| MBO          | 30730  |
| MDS          | 30713  |
| Mecotek      | 30770  |
| Medion       | 30831, 32966,<br>30741, 30630                            |
| Memorex      | 30831, 32213   |
| Metz         | 30713, 30571   |
| Micromedia   | 30503, 30539   |
| Micromega    | 30539  |
| Microsoft    | 31708, 32083,<br>30522                                   |
| Microstar    | 30831  |
| Minax        | 30713  |
| Minoka       | 30770  |
| Mitsubishi   | 34004, 30713   |
| Mizuda       | 30770  |
| Mustek       | 30730  |
| Mystral      | 30831  |
| NAD          | 30741  |
| Naiko        | 30770  |
| NEC          | 30741, 31602   |
| Nevir        | 30831, 30770   |
| Nisato       | 31233  |
| Noblex       | 31233  |
| Norcent      | 30872  |
| Nordmende    | 30831  |
| OK.          | 32966  |
| OKI          | 32966  |
| Onkyo        | 30627, 32147,<br>31612, 31769,<br>30503, 30571,<br>31634 |
| Oppo         | 32545, 30575   |
| Orava        | 30713  |
| Orbit        | 30872  |
| Orion        | 30713, 31233   |
| Ormond       | 30713  |
| Pacific      | 30831, 30713   |
| Packard Bell | 30831  |
| Palladium    | 30713  |

|            |  |
|------------|--|
| Panasonic  | 30490, 31579,<br>31641, 32710,<br>33641, 33862,<br>32523                         |
| Philco     | 30675  |
| Philips    | 32056, 30539,<br>31354, 32789,<br>32434, 30646,<br>31340, 30503,<br>30675, 32084 |
| Pioneer    | 31571, 30631,<br>30571, 32442,<br>32854, 30142                                   |
| Polaroid   | 32966  |
| Polk Audio | 30539  |
| Portland   | 30770  |
| Powerpoint | 30872  |
| Presidian  | 30675  |
| Prinz      | 30831  |
| Prism      | 30831  |
| Pro Vision | 30730  |
| Proline    | 32966  |
| Proscan    | 30522  |
| Proson     | 30713  |
| Prosonic   | 32966  |
| Pye        | 30539, 30646   |
| Radionette | 30741  |
| Radiotone  | 30713  |
| RCA        | 30522, 32213,<br>30571, 31769  |
| REC        | 30490  |
| Red        | 32213  |
| Red Star   | 30770  |
| Richmond   | 31233  |
| Roadstar   | 30713, 30730   |
| Ronin      | 30872  |
| Rotel      | 30623  |
| Rowa       | 30872  |
| Saba       | 30551  |
| Saivod     | 30831  |
| Salora     | 30741  |

|                 |   |
|-----------------|---|
| Samsung         | 30199, 30573,<br>33195, 31635,<br>32369, 32489,<br>32329, 30490,<br>31044 |
| Sanyo           | 32966, 30713,<br>31233  |
| ScanMagic       | 30730   |
| Schaub Lorenz   | 30770   |
| Schneider       | 30539, 30831,<br>30646, 30713   |
| Schontech       | 30713   |
| Scott           | 31233   |
| SEG             | 30713, 30872  |
| Semp            | 30503   |
| Semp Toshiba    | 30503   |
| Sharp           | 30630, 32250,<br>30713, 32966,<br>30675                                   |
| Sherwood        | 30741, 30770  |
| Shinsonic       | 30533   |
| Sigmathek       | 32139   |
| Silva Schneider | 30831, 30741  |
| Skantic         | 30713, 30539  |
| Skymaster       | 30730   |
| SM Electronic   | 30730   |
| Smart           | 30713   |
| Sonashi         | 30831   |
| Soniq           | 30831   |
| Sony            | 31633, 31516,<br>30533, 31033,<br>31070, 30864,<br>32861, 31536,<br>32180 |
| Sound Color     | 31233   |
| Soundwave       | 30713   |
| Spectra         | 30872   |
| SR Standard     | 30831   |
| Strong          | 30713   |
| Sunkai          | 30770   |
| Sunstech        | 30831, 32139,<br>32966  |

|                    |  |
|--------------------|--|
| Supratech          | 32139  |
| Sylvania           | 30675, 30630   |
| Symphonic          | 30675  |
| Sytech             | 30831  |
| Tandberg           | 30713  |
| Targa              | 30741  |
| Tascam             | 31818  |
| Tatung             | 30770  |
| TBoston            | 32139  |
| Tchibo             | 30741  |
| TCM                | 30741  |
| Teac               | 30571, 30675,<br>30741, 31818,<br>32139, 34004           |
| Technica           | 30713  |
| Technics           | 30490  |
| Technika           | 30770, 30831   |
| Technosonic        | 30730  |
| Techwood           | 30713, 32966   |
| Telefunken         | 30551, 32966   |
| Teletch            | 30713  |
| Tensai             | 30770  |
| Theta Digital      | 30571  |
| Thomson            | 30551, 30522,<br>30831                                   |
| Tokai              | 31233  |
| Toshiba            | 30503, 32705,<br>32277, 31769,<br>33157, 32966,<br>32551 |
| TRANS-continentals | 30831, 30872,<br>31233                                   |
| Tranasonic         | 30730  |
| Trevi              | 30831  |
| TVE                | 30713  |
| United             | 30713, 30675,<br>30730, 31233                            |
| Universum          | 30713, 30741   |
| Urban Concepts     | 30503  |
| Venturer           | 31769  |
| Vestel             | 30713  |
| VIZIO              | 32563  |

|            |  |
|------------|--|
| Voxson     | 30831, 30730                                   |
| Waitec     | 30730, 31233                                   |
| Walker     | 32966  |
| Waltham    | 30713  |
| Welkin     | 30831  |
| Wellington | 30713  |
| Weltstar   | 30713  |
| Wharfedale | 30713  |
| Wilson     | 31233, 30831                                   |
| Windsor    | 30713  |
| Windy Sam  | 30573  |
| Woxter     | 32139  |
| X-View     | 31233  |
| Xbox       | 31708, 32083,<br>30522                         |
| Xiron      | 30713  |
| XMS        | 30770  |
| Yamada     | 30872, 32139                                   |
| Yamaha     | 30539, 30817,<br>30490, 32298,<br>31354, 30646 |
| Yamakawa   | 30872  |
| Yukai      | 30730  |
| Zenith     | 30741, 30503                                   |

#### ■ Blu-ray Disc

|            |  |
|------------|--|
| Denon      | 32258, 32748,<br>33851                                   |
| Elite      | 32854  |
| Funai      | 30675  |
| Insignia   | 32596, 30675   |
| Integra    | 32147, 32900,<br>32910, 33100,<br>33101, 33500,<br>33501 |
| Lexicon    | 32545  |
| LG         | 31602, 30741   |
| Magnavox   | 30675  |
| Marantz    | 32414, 33444   |
| Mitsubishi | 34004  |

|           |  |
|-----------|--|
| Onkyo     | 32147, 32900,<br>33101, 33501,<br>32910, 33100,<br>33500 |
| Oppo      | 32545  |
| Panasonic | 31641, 33641,<br>33862, 32523,<br>32710                  |
| Philips   | 32789, 32434,<br>32084                                   |
| Pioneer   | 32442, 32854,<br>30142                                   |
| Samsung   | 30199, 33195   |
| Sharp     | 32250  |
| Sony      | 31516, 32180   |
| Sylvania  | 30675  |
| Tascam    | 31818, 34004   |
| Toshiba   | 32705, 33157,<br>32551                                   |
| VIZIO     | 32563  |
| Yamaha    | 32298  |

#### ■ DVD-R

|           |                               |
|-----------|-------------------------------|
| Accurian  | 30675                         |
| Aristona  | 30646                         |
| Denon     | 30490                         |
| Emerson   | 30675                         |
| Funai     | 30675                         |
| Go Video  | 30741                         |
| GPX       | 30741                         |
| Hitachi   | 31664                         |
| Humax     | 30646                         |
| Irradio   | 30646                         |
| LG        | 30741                         |
| Loewe     | 30741                         |
| Magnavox  | 30675, 30646                  |
| Medion    | 30741                         |
| Panasonic | 30490, 31579,<br>32710, 32523 |
| Philips   | 30646, 31340                  |
| Pioneer   | 30631                         |

|           |  |
|-----------|--|
| Pye       | 30646  |
| RCA       | 30522  |
| Samsung   | 31635, 30490,<br>32489                                   |
| Schneider | 30646  |
| Sharp     | 30630, 30675   |
| Sony      | 32861, 31070,<br>31516, 31033,<br>31536, 32180,<br>31633 |
| Sylvania  | 30675  |
| Targa     | 30741  |
| Thomson   | 30551  |
| Toshiba   | 32277, 32551   |
| Yamaha    | 30646  |
| Zenith    | 30741  |

#### ■ VCR

|            |              |
|------------|--------------|
| DirecTV    | 20739        |
| Humax      | 20739        |
| Panasonic  | 20616        |
| Philips    | 20739        |
| RCN        | 20739        |
| ReplayTV   | 20616        |
| Sonic Blue | 20616        |
| Sony       | 20636        |
| TiVo       | 20739, 20636 |

#### ■ Cable Set Top Box (A to E)

|                                |                        |
|--------------------------------|------------------------|
| 3 Rivers Telephone Cooperative | 01376                  |
| Accelplus                      | 01376, 01877,<br>01982 |
| Access Cable Television        | 01376, 01877,<br>01982 |
| Access Communications          | 01376, 01877           |
| Ace Communications             | 02586                  |
| ACTV Cablevision               | 01376, 01877,<br>01982 |
| Adams Cable TV                 | 01376                  |

|                                   |  |
|-----------------------------------|--|
| A DB                              | 02586, 01920,<br>01481, 01998,<br>02437, 03028 |
| Advanced Broadband                | 01376, 01877,<br>01982                         |
| Advanced Telemedia                | 01376, 01877,<br>01982                         |
| Airwave Networks                  | 01376, 01982                                   |
| Akado                             | 02043  |
| Alabama Broadband                 | 01376  |
| Alcom                             | 02437  |
| Algona Municipal<br>Utilities     | 01376, 01877,<br>01982                         |
| All West<br>Communications        | 01376  |
| Alleghany Cablevision             | 01376, 01877,<br>01982                         |
| Allegiance<br>Communications      | 01376  |
| Alliance<br>Communications        | 01376  |
| Allied Telesis                    | 01376, 01877,<br>01982                         |
| Almega Cable                      | 01376, 01877,<br>01982                         |
| Alpine Cable                      | 01376, 01877,<br>01982                         |
| Alta Utilities                    | 01877  |
| Alternative Cable                 | 01376, 01877,<br>01982                         |
| Altibox                           | 02437  |
| Altitude<br>Communications        | 01376  |
| Americable<br>International       | 01877  |
| American Broadband                | 01376, 01877,<br>01982                         |
| American<br>Entertainment Network | 01376, 01877,<br>01982                         |
| American Telecasting              | 01376, 01877,<br>01982                         |
| Amherst Telephone                 | 01376, 01877,<br>01982                         |

|                                |   |
|--------------------------------|---|
| Amino                          | 01615, 01481,<br>01898, 01998,<br>03028 |
| Anne Arundel<br>Broadband      | 01376                                   |
| Antietam Cable                 | 01376, 01877,<br>01982                  |
| Arc One                        | 01376, 01877,<br>01982                  |
| Arctic Cooperatives            | 01376, 01877,<br>01982                  |
| Argent<br>Communications       | 01376, 01877,<br>01982                  |
| Arialink Broadband             | 01376, 01877,<br>01982                  |
| Arkwest                        | 01481, 01998,<br>03028                  |
| Arledge Electronics            | 01376                                   |
| Armstrong                      | 01376, 01877                            |
| Arris                          | 02187                                   |
| Arvig Communication<br>Systems | 01376, 01982,<br>01998, 02345           |
| Ashland Home Net               | 01376, 01877,<br>01982                  |
| Askivision Systems             | 01376, 01877,<br>01982                  |
| Astound Broadband              | 01376, 01877                            |
| AT&T                           | 00858                                   |
| ATC Communications             | 01376                                   |
| Atlantic Broadband             | 01877, 01376                            |
| ATMC                           | 01376, 01982,<br>01998, 03028           |
| Atwood Cable                   | 01376, 01877,<br>01982                  |
| Aurora Cable TV                | 01376, 01877,<br>01982                  |
| Ayrshire<br>Communications     | 01376, 01877,<br>01982                  |
| B & C Cablevision              | 01376, 01877,<br>01982                  |
| B & L Technologies             | 01376, 01877,<br>01982                  |
| Bailey Cable TV                | 01376, 01877,<br>01982                  |

|  |                        |
|--|------------------------|
| Baja Broadband                         | 01376                  |
| Baldwin County<br>Internet             | 01376, 01877,<br>01982 |
| Baldwin Telecom                        | 01877                  |
| Ballard Rural<br>Telephone Cooperative | 02586                  |
| Barbourville Utility<br>Commission     | 01376, 01877,<br>01982 |
| Bardstown Cable                        | 01376, 01877,<br>01982 |
| Bascom<br>Communications               | 01376, 01877,<br>01982 |
| Base Cablevision                       | 01376, 01877,<br>01982 |
| Bay Cablevision                        | 01376, 01877,<br>01982 |
| Bay City Cablevision                   | 01376, 01877,<br>01982 |
| Bay Country<br>Communications          | 01376, 01877,<br>01982 |
| Bay Creek<br>Communications            | 01376                  |
| Bayland<br>Communications              | 02586                  |
| Bayou Cable                            | 01376, 01877,<br>01982 |
| Beamspeed                              | 01376, 01877,<br>01982 |
| Beaver Creek<br>Telephone              | 01877, 01982           |
| Beaver Valley Cable                    | 01376, 01877,<br>01982 |
| Beck's Cable Systems                   | 01376, 01877,<br>01982 |
| Bee Line Cable                         | 01376                  |
| Beeline                                | 03028                  |
| BELD Broadband                         | 01376, 01877,<br>01982 |
| Belgacom TV                            | 02132                  |
| Belhaven Cable TV                      | 01376, 01877,<br>01982 |
| Bell                                   | 01998                  |
| Bell Aliant                            | 01998                  |
| Bell Fibe TV                           | 01998                  |

|                                   |                        |
|-----------------------------------|------------------------|
| Bellaire Cable                    | 01376, 01877,<br>01982 |
| Bellevue Cable                    | 01376, 01877,<br>01982 |
| Bend Broadband                    | 01376, 02187           |
| Bentleyville Cable                | 01376, 01877,<br>01982 |
| Benton Cooperative<br>Telephone   | 01376, 01877,<br>01982 |
| Beresford Cablevision             | 01376, 01877,<br>01982 |
| Berkshire Cable Corp              | 01376, 01877,<br>01982 |
| Beulah Cable TV                   | 01376, 01877,<br>01982 |
| Bevcomm                           | 01615, 01898           |
| Beyond<br>Communications          | 01376, 01877,<br>01982 |
| Big Sandy Broadband               | 01376, 01877,<br>01982 |
| Biltmore<br>Communications        | 01877, 01982           |
| Blakely Cable<br>Television       | 01376, 01877,<br>01982 |
| Bledsoe Telephone<br>Cooperative  | 01481, 01998,<br>03028 |
| Bloomingtondale<br>Communications | 01481, 01998,<br>03028 |
| Blue Mountain TV<br>Cable         | 01376, 01877,<br>01982 |
| Blue Ridge<br>Communications      | 01877                  |
| Blue Sky Cable                    | 01376, 01877,<br>01982 |
| Blue Valley<br>Telecommunications | 01898                  |
| Bobcaygeon Cable                  | 01376, 01877,<br>01982 |
| Booher Brothers Cable             | 01376, 01877,<br>01982 |
| Bouygues Telecom                  | 03007                  |
| Bowen Cablevision                 | 01376, 01877,<br>01982 |
| Boycom Cablevision                | 01376                  |

|                                      |                     |
|--------------------------------------|---------------------|
| Branch Cable                         | 01376, 01877, 01982 |
| Brandenburg Telecom                  | 01481, 01998, 03028 |
| Brandywine Cablevision               | 01376, 01877, 01982 |
| Bresnan                              | 01376, 01877        |
| Briand et Moreau Cable               | 01376, 01877, 01982 |
| Bright Green Communications          | 01376, 01877, 01982 |
| Bright House                         | 01877, 01376        |
| Bristol Tennessee Essential Services | 01877, 01998        |
| Bristol Virginia Utilities           | 01376, 01877, 01982 |
| British American                     | 01376, 01877, 01982 |
| Broadstar Communications             | 01376, 01877, 01982 |
| Broadstripe                          | 01376               |
| Brockway Television                  | 01376, 01877, 01982 |
| Broken Bow Cable TV                  | 01376, 01877, 01982 |
| Brooks Bay Cable                     | 01376, 01877, 01982 |
| Brownwood TV Cable Service           | 01376, 01877, 01982 |
| Bryan Municipal Utilities            | 01376, 01877, 01982 |
| BT                                   | 02294               |
| BTC Broadband                        | 02586               |
| Buckeye Cable System                 | 01877, 01376, 02187 |
| Bulldog Cable                        | 01376, 01877, 01982 |
| Bulloch Telephone Cooperative        | 01376, 01877, 01982 |
| Burlington Telecom                   | 01481, 01615        |
| Butler Bremer Mutual Telephone       | 01898               |
| Byron Cable TV                       | 01376, 01877, 01982 |

|                                   |                     |
|-----------------------------------|---------------------|
| C & W Cable                       | 01376, 01877, 01982 |
| C.L. Davis Cable Services         | 01376, 01877, 01982 |
| Cable & Communications            | 01376               |
| Cable America                     | 01376, 01877        |
| Cable Axiom Digital               | 01376               |
| Cable Communications of Willsboro | 01376, 01877, 01982 |
| Cable Cooperative                 | 01376, 01877, 01982 |
| Cable Development Corporation     | 01376, 01877, 01982 |
| Cable Management Association      | 01376, 01877, 01982 |
| Cable Montana                     | 01376, 01877, 01982 |
| Cable Nebraska                    | 01376, 01877, 01982 |
| Cable Of The Carolinas            | 01376, 01877, 01982 |
| Cable One                         | 01376, 01877        |
| Cable Plus                        | 01376, 01877, 01982 |
| Cable Suite                       | 01376               |
| Cable Tech Cable TV               | 01376, 01877, 01982 |
| Cable TV of Camrose               | 01376               |
| Cable TV of East Alabama          | 01376, 01877, 01982 |
| Cable TV of Slave Lake            | 01376, 01877, 01982 |
| Cable TV of St. Paul              | 01376, 01877, 01982 |
| Cable Vision Services             | 01877               |
| Cablecom                          | 01582               |
| Cablecom Mexico                   | 01376               |
| Cablemas                          | 01376, 01877        |
| Cablenet                          | 01376, 01877, 01982 |
| CableSouth Media                  | 01376, 01877, 01982 |

|                              |                     |
|------------------------------|---------------------|
| Cableview Communications     | 01376, 01877, 01982 |
| Cablevision                  | 01877, 01376        |
| Cablevision du Nord          | 01376               |
| Cablevision of Marion County | 01376               |
| Cablevision T.R.P.           | 01376, 01877, 01982 |
| Cabovis                      | 02436               |
| Caiway                       | 02015, 0660         |
| CalNeva Broadband            | 01376, 01877, 01982 |
| CalTel Connections           | 02586               |
| Cameron Communications       | 01376, 01877, 01982 |
| CAMS Cable                   | 01376, 01877, 01982 |
| Canby Telcom                 | 01481               |
| Cannon Valley Cablevision    | 01481, 01998, 03028 |
| Caprock TV                   | 01376, 01877, 01982 |
| Carnegie Cable               | 01376, 01877, 01982 |
| Carolina Mountain Cable      | 01376, 01877, 01982 |
| Carr Communications          | 01376, 01877, 01982 |
| Carrell Communications       | 01376, 01877, 01982 |
| CAS Cable                    | 01376               |
| Cascade Communications       | 01376, 01877, 01982 |
| Casey Cable                  | 01376, 01877, 01982 |
| Caspian Community TV         | 01376, 01877, 01982 |
| Cass Cable                   | 01376               |
| Castle Cable Service         | 01376, 01877, 01982 |
| Catalina Cable               | 01376, 01877, 01982 |
| Catawba Services             | 01376, 01877, 01982 |

|                                   |                     |
|-----------------------------------|---------------------|
| CBN                               | 01376, 01877, 01982 |
| CBPU Cable                        | 01376, 01877, 01982 |
| CCAP                              | 01877               |
| CDE Lightband                     | 00858, 01615, 02586 |
| Cedar Falls Utilities             | 01376               |
| Celect Communications             | 01376, 01877, 01982 |
| Cencom                            | 01376, 01877, 01982 |
| CentraCom Interactive             | 01376, 01877, 01982 |
| Central Texas Communications      | 01376, 01877, 01982 |
| Central Valley Cable              | 01376, 01877, 01982 |
| Centre TV Cable                   | 01376, 01877, 01982 |
| Centrovision                      | 01376, 01877, 01982 |
| Century Communications            | 01376, 01877, 01982 |
| Century Telephone                 | 01376, 01877, 01982 |
| CenturyLink                       | 01998               |
| CenturyTel TeleVideo              | 01376, 01877, 01982 |
| Chambers Cable                    | 01376               |
| Champion Broadband                | 01376, 01877, 01982 |
| Chaparral Cablevision             | 01376, 01877, 01982 |
| Chariton Valley Communications    | 01376, 01877, 01982 |
| Charter                           | 01376, 01877, 02187 |
| Chatmoss Cablevision              | 01376, 01877, 01982 |
| Chequamegon Telephone Cooperative | 01898, 01615        |
| Chesnee Communications            | 01376, 01877, 01982 |

|                              |  |
|------------------------------|--|
| Chester Telephone            | 01376  |
| Chinook Progressive Club TV  | 01376, 01877, 01982  |
| Chippewa Valley Cable        | 01376, 01877, 01982  |
| Choice Cable TV              | 01376, 01877, 01982  |
| Choice Communications        | 01376, 01877, 01982  |
| Choice Television            | 01376, 01877, 01982  |
| ChoiceCable                  | 01376  |
| Christy Cablevision          | 01376, 01877, 01982  |
| CimTel                       | 01376  |
| Cincinnati Bell              | 01877, 01376   |
| Circle Bar Cable Television  | 01376, 01877, 01982  |
| Cisco                        | 01877, 01982, 00858, 02589, 03028, 02132, 02345, 01582, 01883, 02378, 02401, 03265 |
| Citizens Cable               | 01376  |
| Citizens Cable TV            | 01376  |
| Citizens Cablevision         | 01481  |
| Citizens Mutual Telephone    | 01376, 01877, 01982  |
| Citizens Telecom             | 01376, 01877, 01982  |
| Citizens Telephone           | 02586  |
| City Cablevision             | 01376, 01877, 01982  |
| City of Barnesville Cable    | 01376, 01877, 01982  |
| City of Baxter Springs Cable | 01376, 01877, 01982  |
| City of Hawarden Cable       | 01376, 01877, 01982  |
| City of Norway Cable         | 01376, 01877, 01982  |
| City of Quitman Cable        | 01376, 01877, 01982  |

|                               |                     |
|-------------------------------|---------------------|
| City Of Salisaw               | 01376               |
| City of Sumas TV Cable System | 01376, 01877, 01982 |
| City West                     | 01376               |
| Citycable                     | 03477               |
| Clarence Telephone            | 01376, 01877, 01982 |
| Claro                         | 01376               |
| Clear Creek Communications    | 01376               |
| Clearview Cable               | 01376, 01877, 01982 |
| Clearview Partners            | 01376, 01877, 01982 |
| Clearview TV Cable            | 01376, 01877, 01982 |
| Clearvision Cable TV          | 01376, 01877, 01982 |
| Click Network                 | 01376               |
| ClickOne                      | 01376, 01877, 01982 |
| Clinton Cable                 | 01376, 01877, 01982 |
| CLT Communications            | 01376, 01877, 01982 |
| ClubInternet                  | 02132               |
| CMA Communications            | 01376               |
| CNS Television                | 01376, 01877, 01982 |
| Coast Cable Communications    | 01376               |
| Coast Cablevision             | 01376, 01877, 01982 |
| Coast Communications          | 01376               |
| Coastal Link                  | 01376               |
| Coaxial Cable TV              | 01376, 01877, 01982 |
| Cobridge                      | 01376               |
| Cobridge Communications       | 01376               |
| Cogeco                        | 01376, 01877, 01982 |
| Colane Cable TV               | 01376, 01877, 01982 |

|                                 |                            |
|---------------------------------|----------------------------|
| Colfax Highline Cable           | 01376, 01877, 01982        |
| Collinsville Cable              | 01376, 01877, 01982        |
| Colonial Cablevision            | 01376, 01877, 01982        |
| ColtonTel                       | 02378                      |
| Columbia Power and Water        | 01376, 01877               |
| Columbus Telephone              | 01376                      |
| Com Hem                         | 00660, 02015               |
| Com-Link                        | 01376, 01877, 01982        |
| Comcast                         | 01376, 01982, 01877, 02187 |
| Communication Services          | 01376, 01877, 01982        |
| Communicomm                     | 01376, 01877, 01982        |
| Community Antenna Service       | 01376, 01877, 01982        |
| Community Antenna System        | 01376, 01877, 01982        |
| Community Cable & Broadband     | 01376                      |
| Community Cable Service         | 01376, 01877, 01982        |
| Community Communications        | 01376, 01877, 01982        |
| Community Telecom               | 01376, 01877, 01982        |
| Community Television            | 01376, 01877               |
| Compas Cable                    | 01376, 01877, 01982        |
| Complete Communication Services | 01376, 01877, 01982        |
| Comserv Ltd                     | 01376, 01877, 01982        |
| ComSouth                        | 01376, 01877, 01982        |
| ComSpan Communications          | 01481, 01898               |

|                                 |                     |
|---------------------------------|---------------------|
| Comstar Cable TV                | 01376, 01877, 01982 |
| Consolidated Cable              | 01376, 01877, 01982 |
| Consolidated Communications     | 01376               |
| Conuma Cable Systems            | 01376, 01877, 01982 |
| Conway Corporation Cable TV     | 01376, 01877, 01982 |
| Conxxus                         | 01376, 01877, 01982 |
| Coon Creek Telephone            | 01376               |
| Coon Rapids Municipal Utilities | 01376, 01877, 01982 |
| Coop CSCF                       | 01376               |
| Cooperative Television Godahl   | 01376, 01877, 01982 |
| CoopTel                         | 00858, 01615, 01898 |
| Coosa Cable                     | 01376               |
| Copper Mountain Metropolitan    | 01376, 01877, 01982 |
| Country Cable                   | 01376, 01877, 01982 |
| Country Cable TV                | 01376, 01877, 01982 |
| Country Cablevision             | 01376               |
| Country Cablevision Ltd.        | 01376               |
| Cowley Telecable                | 01376, 01877, 01982 |
| Cox                             | 01877, 01376        |
| Craig Cable TV                  | 01376, 01877, 01982 |
| Craw-Kan Telephone Cooperative  | 02586               |
| Crestview Cable                 | 01376, 01877, 01982 |
| Cross Country TV                | 01376, 01877, 01982 |
| Crosslake Communications        | 01376, 01877, 01982 |



|                                   |                        |
|-----------------------------------|------------------------|
| Crow Cable TV                     | 01376, 01877,<br>01982 |
| CRRS-TV                           | 01376                  |
| CRST Telephone Authority          | 01481, 01998,<br>03028 |
| Crystal Cable TV                  | 01376, 01877,<br>01982 |
| CSI Cable                         | 01376, 01877,<br>01982 |
| CT & R Cable                      | 01376, 01877,<br>01982 |
| CTC                               | 01376                  |
| Cunningham Telephone & Cable      | 01376                  |
| Curtis Cable TV                   | 01376, 01877,<br>01982 |
| CUTV                              | 01376, 01877,<br>01982 |
| CWA Cable                         | 01376, 01877,<br>01982 |
| D & D Cable Systems               | 01376, 01877,<br>01982 |
| D & P Communications              | 01376                  |
| Daeryung                          | 01877                  |
| Dairyland Cable Systems           | 01376, 01877,<br>01982 |
| Dakota Central Telecommunications | 02345                  |
| Dalton Cable Television           | 01877, 01982           |
| Darty Box                         | 02436                  |
| Davis Communications              | 01376, 01877,<br>01982 |
| Dawson City Television            | 01376, 01877,<br>01982 |
| DCA Cablevision                   | 01376, 01877,<br>01982 |
| DDD Cablevision                   | 01376, 01877,<br>01982 |
| Dean Hill Cable                   | 01376, 01877,<br>01982 |
| Dean's Cablevision                | 01376, 01877,<br>01982 |

|                              |                        |
|------------------------------|------------------------|
| Decca Cable                  | 01376, 01877,<br>01982 |
| Deffner Cable TV             | 01376, 01877,<br>01982 |
| Delhi Telephone              | 01376, 01877,<br>01982 |
| Delta                        | 02015, 00660           |
| Delta Cable                  | 01376                  |
| Demopolis CATV               | 01376, 01877,<br>01982 |
| Denali TV                    | 01376, 01877,<br>01982 |
| Dery Telecom                 | 01376                  |
| Deutsche Telekom             | 02132                  |
| Dickey Rural Networks        | 01376, 01877,<br>01982 |
| Digeo                        | 02187                  |
| Diode Communications         | 01376, 01877,<br>01982 |
| Diverse Communications       | 01898, 01982           |
| Dixie Cable TV               | 01376, 01877,<br>01982 |
| Dixon Telephone              | 01376, 01877,<br>01982 |
| DMS Cable                    | 01376, 01877,<br>01982 |
| Downsville Community Antenna | 01376, 01877,<br>01982 |
| Doylestown Cable TV          | 01376, 01877,<br>01982 |
| Drummond Cable TV            | 01376, 01877,<br>01982 |
| DTC                          | 01376, 01877,<br>01982 |
| Du                           | 02401                  |
| Dumont Telephone             | 01376, 01877,<br>01982 |
| Duncan Cable TV              | 01376, 01877,<br>01982 |
| Eagle Broadband              | 01481, 01998,<br>03028 |

|                                  |                        |
|----------------------------------|------------------------|
| Eagle Cablevision                | 01376, 01877,<br>01982 |
| Eagle Communications             | 01376, 02187           |
| Eagle Valley Telephone           | 01481, 01998,<br>03028 |
| EagleVision Wireless TV Services | 01376, 01877,<br>01982 |
| East Arkansas Video              | 01376                  |
| East Cleveland Cable             | 01376, 01877,<br>01982 |
| East Texas Cable                 | 01376, 01877,<br>01982 |
| Eastern Cable                    | 01376, 01877,<br>01982 |
| EastLink                         | 01376                  |
| Easton Cable                     | 01877                  |
| EasyTEL                          | 01481, 01998,<br>03028 |
| Eatel                            | 01877                  |
| Echostar                         | 03452                  |
| Electron Enterprises             | 01376, 01877,<br>01982 |
| Elk River Cable TV               | 01376, 01877,<br>01982 |
| Elkhart TV Cable                 | 01376, 01877,<br>01982 |
| Emery Telcom Video               | 01376, 01877,<br>01982 |
| Emily Coop Telephone             | 01481, 01615           |
| Enhanced Telecommunications      | 01376                  |
| EnTouch                          | 01376                  |
| EPB of Chattanooga               | 00858                  |
| Escape Broadband                 | 01376, 01877,<br>01982 |
| Eston CATV Cooperative           | 01376, 01877,<br>01982 |
| ETAN Industries                  | 01376, 01877,<br>01982 |
| Etex                             | 02586                  |
| Execulink                        | 01376                  |
| Eyecom                           | 01376, 01877,<br>01982 |

### ■ Cable Set Top Box (F to J)

|                                       |                        |
|---------------------------------------|------------------------|
| F & B Telephone                       | 02586                  |
| FairPoint Communications              | 01376, 01877,<br>01982 |
| Falls Earth Station                   | 01376, 01877,<br>01982 |
| FamilyView Cablevision                | 01376, 01877,<br>01982 |
| Fannettsburg Cable TV                 | 01376, 01877,<br>01982 |
| Farmer & Merchant Mutual              | 01376, 01877,<br>01982 |
| Farmer's Telephone Cooperative        | 01998, 03028           |
| Farmers Independent Telephone         | 01376, 01877,<br>01982 |
| Farmers Mutual Telephone              | 01376, 01877,<br>01982 |
| Fayetteville Electric System          | 01877                  |
| Federated Telephone                   | 01376                  |
| Fenton Cablevision                    | 01376, 01877,<br>01982 |
| FiberCast Cable Communications        | 01376, 01877,<br>01982 |
| FiberNet Monticello                   | 01376, 01877,<br>01982 |
| Fibrant                               | 01376, 01877,<br>01982 |
| Fidelity Communications               | 01376                  |
| First Cable Of Missouri               | 01376, 01877,<br>01982 |
| FirstMile                             | 01376, 01877,<br>01982 |
| Flint Cable TV                        | 01376, 01877,<br>01982 |
| Florida Cable                         | 01376                  |
| Foothills Rural Telephone Cooperative | 01877                  |
| Forsyth CableNet                      | 01376, 01877,<br>01982 |

|                                   |                     |
|-----------------------------------|---------------------|
| Fort Jennings Communications      | 02586               |
| Fort Towson Cable                 | 01376, 01877, 01982 |
| Foster Communications             | 01376, 01877, 01982 |
| Frank Howard TV Cable             | 01376, 01877, 01982 |
| Frankfort Plant Board Cable       | 01376               |
| Freebox                           | 01976               |
| FTC                               | 01877, 01982, 01376 |
| Full Channel TV                   | 01376, 01877, 01982 |
| Full Choice Communications        | 01376, 01877, 01982 |
| Fusion Broadband                  | 01376, 01877, 01982 |
| Futuristic Cablevision            | 01376, 01877, 01982 |
| Galaxy American Communication     | 01376, 01877, 01982 |
| Galaxy Cable                      | 01376, 01877, 01982 |
| Gardonville Cooperative Telephone | 01998               |
| Gatehouse Networks                | 01376, 01877, 01982 |
| Gauthier Cablevision & Electric   | 01376, 01877, 01982 |
| GCI                               | 01877               |
| General Communications            | 01376               |
| Genext                            | 01376, 01877, 01982 |
| Geraldine Cable TV                | 01376, 01877, 01982 |
| Get Real Cable                    | 01376, 01877, 01982 |
| GEUS                              | 01376, 01877, 01982 |
| Giant Communications              | 01376, 01877, 01982 |

|                                |                     |
|--------------------------------|---------------------|
| Giles-Craig Communications     | 01376, 01877, 01982 |
| Gilmer Cable Television        | 01376, 01877, 01982 |
| Glasgow Electric Plant Board   | 01376, 01877, 01982 |
| Glass Antenna Systems          | 01376, 01877, 01982 |
| Glenwood Telecommunications    | 01376               |
| Glide Cablevision              | 01376, 01877, 01982 |
| Globalcom                      | 01376, 01877, 01982 |
| Golden Belt Telephone          | 02586               |
| Golden Communications          | 01376, 01877, 01982 |
| Golden Rain Foundation         | 01376, 01877, 01982 |
| Golden Valley Cable            | 01376, 01877, 01982 |
| Golden West Telecommunications | 01376, 01877, 01982 |
| Goldfield Communications       | 01376, 01877, 01982 |
| Gorham Communications          | 01481               |
| Gowrie Cablevision             | 01376, 01877, 01982 |
| Grafton Cable Communications   | 01376, 01877, 01982 |
| Grand River Cable              | 01376, 01877, 01982 |
| Grande Communications          | 01877, 01376        |
| Great Plains Communications    | 01376               |
| Green Hills Communications     | 01376, 01877, 01982 |
| Greene County Cable TV         | 01376, 01877, 01982 |
| Greenlight Community Broadband | 01376, 01877, 01982 |

|                                |                                   |
|--------------------------------|-----------------------------------|
| Gridley Cable                  | 01376, 01877, 01982               |
| Griswold Cooperative Telephone | 01481, 01998, 03028               |
| Grove Cable                    | 01376, 01877, 01982               |
| Grundy Center Utilities GTI    | 01376, 01877, 01481, 01998, 03028 |
| Guadalupe Valley               | 01877                             |
| Haefele TV                     | 01376, 01877, 01982               |
| Haines Cable TV                | 01376, 01877, 01982               |
| Hall Beach Cooperative         | 01376, 01877, 01982               |
| Hamilton County Cable TV       | 01877, 01982, 01376               |
| Hancel                         | 01376, 01877, 01982               |
| Hargray                        | 01376, 01877, 01982               |
| Harlan Community TV            | 01376                             |
| Harlan Municipal Utilities     | 01376                             |
| Harmony Cable TV               | 01376, 01877, 01982               |
| Harris Broadband               | 01376                             |
| Harrisonville Telephone        | 02586                             |
| Harron Metrocast               | 01376, 01877                      |
| Hart Cable                     | 01376, 01877, 01982               |
| Hart Electric                  | 01376, 01877, 01982               |
| Hartelco                       | 01376, 01877, 01982               |
| Hastings Cable Vision          | 01376, 01877, 01982               |
| Hathw@y                        | 02043                             |
| Hawaiian Telcom                | 03028                             |
| HBC                            | 01376, 01877, 01982               |

|                                   |                     |
|-----------------------------------|---------------------|
| HBL Communications                | 01376, 01877, 01982 |
| HCS                               | 01376, 01877, 01982 |
| Healthcare Cable Systems          | 01376, 01877, 01982 |
| Heart of Iowa Communications      | 01376, 01877, 01982 |
| Heartland Cable                   | 01376, 01877, 01982 |
| Heartland Wireless Communications | 01376, 01877, 01982 |
| Heck's TV & Cable                 | 01376, 01877, 01982 |
| Henderson Telephone               | 01376, 01877, 01982 |
| Hermosa Cablevision               | 01376, 01877, 01982 |
| Herr Cable                        | 01376, 01877, 01982 |
| HFU Television                    | 01376, 01877, 01982 |
| Hiawatha Broadband                | 01376, 01877, 01982 |
| HickoryTech                       | 01898               |
| High Plains Cablevision           | 01376, 01877, 01982 |
| Highland                          | 01376, 01877, 01982 |
| Hill Top Communications           | 01376, 01877, 01982 |
| Hinton CATV                       | 01376, 01877, 01982 |
| HLM Cable Corp                    | 01376, 01877, 01982 |
| HomeTel                           | 01376               |
| Hometown Cable                    | 01376, 01877, 01982 |
| Hometown Utilicom                 | 01376, 01877, 01982 |
| Hood Canal Cablevision            | 01376               |
| Hoonah Community Television       | 01376, 01877, 01982 |

|                                    |                            |
|------------------------------------|----------------------------|
| Hooper Telephone                   | 01376, 01877, 01982        |
| Horizon Cable TV                   | 01376, 02586               |
| Horizon Telecom                    | 02586                      |
| Horry Telephone Cooperative        | 01376, 01877, 01982        |
| Hospers Telephone                  | 01376, 01877, 01982        |
| Hotwire                            | 02586                      |
| Houston Cable                      | 01376, 01877, 01982        |
| Hrvatski Telekom                   | 02132                      |
| HTC Communications                 | 01481, 01998, 03028        |
| HTC Services                       | 01376, 01877, 01982        |
| Humax                              | 00660, 02620, 02043, 02165 |
| HunTel Systems                     | 01376                      |
| Huxley Communications              | 01376, 01877, 01982        |
| Hydaburg Cable TV                  | 01376, 01877, 01982        |
| HYDE County Cablevision            | 01376, 01877, 01982        |
| i-CAN                              | 02437                      |
| I-Speed                            | 01376, 01877, 01982        |
| ICE Cable Holdings                 | 01376                      |
| ICS Communications                 | 01376, 01877, 01982        |
| Illini Cablevision Of Illinois     | 01376, 01877, 01982        |
| ImOn Communications                | 01877                      |
| Indco Cable TV                     | 01376, 01877, 01982        |
| Independence Telecom Utility       | 01376, 01982               |
| Independent Cable Systems of Idaho | 01376, 01877, 01982        |
| Indevideo                          | 01376, 01877, 01982        |
| Index Cable TV                     | 01376, 01877, 01982        |

|                                    |                            |
|------------------------------------|----------------------------|
| Innovative Cable TV                | 01376                      |
| Innovative Systems                 | 01898                      |
| Inotel                             | 02437                      |
| Inside Connect Cable               | 01376                      |
| Insight                            | 01376, 01877               |
| Integra Telecom                    | 02345                      |
| Inter Mountain Cable               | 01877                      |
| Inter-County Cable                 | 01376, 01877, 01982        |
| Interstate Cablevision             | 01481, 01998, 03028        |
| Intertech Private Cable            | 01376, 01877, 01982        |
| InviTV                             | 02437                      |
| Iron River Cooperative TV          | 01376, 01877, 01982        |
| Irvine Community TV                | 01376, 01877, 01982        |
| ITV-3                              | 01376, 01877, 01982, 03028 |
| J & L Cable                        | 01376, 01877, 01982        |
| J & N Cable                        | 01376, 01877, 01982        |
| Jack McClanahan Cable TV           | 01376, 01877, 01982        |
| Jackson Energy Authority           | 01376, 01877, 01982        |
| Jaguar Communications              | 01376, 01877, 01982        |
| James Cable Partners               | 01376, 01877, 01982        |
| James Valley Cooperative Telephone | 02586                      |
| Jayroc Cablevision                 | 01376, 01877, 01982        |
| Jefferson County Cable             | 01376, 01877, 01982        |
| Jefferson Telecom                  | 01376, 01877, 01982        |
| Jeffersonville Cable TV            | 01376, 01877, 01982        |
| Jet Broadband                      | 01376                      |

|                       |                     |
|-----------------------|---------------------|
| Johnston County Cable | 01376, 01877, 01982 |
| Journeyvision Cable   | 01376, 01877, 01982 |
| JP PTT                | 01615               |

#### ■ Cable Set Top Box (K to N)

|                                       |                     |
|---------------------------------------|---------------------|
| K-Communications                      | 01376, 01877, 01982 |
| Kabel Deutschland                     | 02165               |
| Kalida Telephone                      | 01376, 01877, 01982 |
| Kalona Cooperative Telephone          | 02586               |
| Kaplan Telephone                      | 02586               |
| Karban TV Systems                     | 01376, 01877, 01982 |
| KAS Cable TV                          | 01376, 01877, 01982 |
| Kaslo Cable                           | 01376, 01877, 01982 |
| KBS Cable TV                          | 01376               |
| Keene Valley Video                    | 01376, 01877, 01982 |
| Kelley Communications                 | 01376, 01877, 01982 |
| Kennebec Telephone                    | 01376, 01877, 01982 |
| Kennedy Cablevision                   | 01376, 01877, 01982 |
| Kentucky Ridge Country Communications | 01376, 01877, 01982 |
| Keta Cable                            | 01376, 01877, 01982 |
| KFW Communications                    | 01376, 01877, 01982 |
| Kincardine Cable TV                   | 01376               |
| Kings Bay Communications              | 01376, 01877, 01982 |
| Kiss                                  | 02132               |
| KLIP                                  | 01376, 01877, 01982 |

|                                     |                                   |
|-------------------------------------|-----------------------------------|
| KM Telecom                          | 01481                             |
| Knology                             | 01877, 01376                      |
| KoolConnect                         | 01481                             |
| Koomiut Cooperative                 | 01376, 01877, 01982               |
| KPN                                 | 02952, 02437                      |
| Kraus Electronic Systems            | 01376, 01877, 01982               |
| Kudzu Cable TV                      | 01376, 01877, 01982               |
| Kugluktuk Cooperative               | 01376, 01877, 01982               |
| Kuhn Communications                 | 01376, 01877                      |
| L & J Cable                         | 01376, 01877, 01982               |
| La Harpe Communications             | 01376, 01877, 01982               |
| La Harpe Video and Data Services    | 01376, 01877                      |
| Lafayette Utilities System          | 01376                             |
| Laguna Serrano Cable                | 01376, 01877, 01982               |
| Lake Cable                          | 01376, 01877, 01982               |
| Lakeland Cablevision                | 01376, 01481, 01877, 01982, 01998 |
| Lakeland Telecom                    | 01481, 01998, 03028               |
| Lakeview Cable                      | 01376, 01877, 01982               |
| Lamont Digital Systems              | 01376, 01877, 01982               |
| Lang                                | 01376, 01877, 01982               |
| Laurel Highland                     | 01376, 01877, 01982, 02187        |
| LB Cable                            | 01376, 01877, 01982               |
| Lehigh Valley Cooperative Telephone | 01376, 01877, 01982               |
| Lemonweir Valley Telephone          | 01481, 01998, 03028               |

|                          |                     |
|--------------------------|---------------------|
| Lexcom Cable Services    | 01376, 01877, 01982 |
| Liberty Cablevision      | 01376               |
| Liberty Communications   | 01481, 02586        |
| Limestone Cablevision    | 01376, 01877, 01982 |
| Lincoln Cable Television | 01376               |
| Lincolntown              | 01376               |
| Lindsey Communications   | 01376, 01877, 01982 |
| LISCO                    | 01376, 01877, 01982 |
| Litestream Holdings      | 01376, 01877, 01982 |
| LNE Telco                | 01376, 01877, 01982 |
| Localtel                 | 01376, 01877, 01982 |
| Lockesburg Cablevision   | 01376, 01877        |
| Lodgenet Entertainment   | 01376, 01877, 01982 |
| Lone Pine Cable TV       | 01376, 01877, 01982 |
| Longview Communications  | 01376, 01877, 01982 |
| Lonsdale Video Ventures  | 01481, 01998, 03028 |
| Loretel Cablevision      | 01376, 01877, 01982 |
| Loretel Systems          | 01376               |
| Lost Island Cable TV     | 01376, 01877, 01982 |
| Lumos Networks           | 01998, 03028        |
| Lycom Communications     | 01376, 01877, 01982 |
| M-Tek Systems            | 01376, 01877, 01982 |
| M.T.C. Cable             | 01376, 01877, 01982 |
| Maddock Cable TV         | 01376, 01877, 01982 |

|                                     |                     |
|-------------------------------------|---------------------|
| Madison Communications              | 01376, 01982        |
| Madison County Cable                | 01376, 01877, 01982 |
| Magio Sat                           | 02132               |
| Magnet                              | 01615               |
| Mahaska Communications              | 01376, 01877, 01982 |
| Mainstreet Communications           | 01376, 01877, 01982 |
| Maitland Cable TV                   | 01376, 01877, 01982 |
| Mallard Cable                       | 01376, 01877, 01982 |
| Manawa Telecom                      | 02586               |
| Manning Municipal Utilities         | 01376, 01877, 01982 |
| Manti Telecom                       | 01481, 01998, 03028 |
| Marco Island Cable                  | 01376, 01877, 01982 |
| Markdale Cable TV                   | 01376               |
| Marne & Elk Horn Telephone          | 01376, 01877, 01982 |
| Marquette-Adams Telephone           | 01376, 01877, 01982 |
| Martelle Communications Cooperative | 01376, 01877, 01982 |
| Mascon Cable                        | 01376               |
| Masset-Haida TV Society             | 01376, 01877, 01982 |
| Massillon Cable                     | 01376               |
| Matanuska Telephone Association     | 01481, 02586        |
| Matrix Cablevision                  | 01376, 01877, 01982 |
| Mattawamkeag Cablevision            | 01376, 01877, 01982 |
| McDonough Telephone Cooperative     | 01376, 01877, 01982 |
| McKee TV Enterprises                | 01376, 01877, 01982 |

|                                  |                     |
|----------------------------------|---------------------|
| McNabb Cable                     | 01376, 01877, 01982 |
| MCV Broadband                    | 01877               |
| Media One                        | 01376, 01877, 01982 |
| Mediacom                         | 01376, 01877, 01982 |
| Mediapolis Telephone             | 01376, 01982        |
| Mediastream                      | 01376               |
| Megacable                        | 01376               |
| Meo                              | 02401               |
| Merrimac Communications          | 01376, 01877, 01982 |
| Metlakatla Indian Community TV   | 01376, 01877        |
| MetroCast Cablevision            | 01376, 01982, 01877 |
| MetroNet                         | 01877, 0858         |
| Metropolitan Cable               | 01376, 01877, 01982 |
| MGS Cablevision                  | 01376, 01877, 01982 |
| MHTC                             | 01481, 01998, 03028 |
| Mi-Connection                    | 01877               |
| Microwave Satellite Technologies | 01481, 01998, 03028 |
| Mid Century Telecom              | 01481, 01615        |
| Mid Missouri Broadband & Cable   | 01376, 01877, 01982 |
| Mid Missouri Telephone           | 01376, 01877, 01982 |
| Mid-Coast Cablevision            | 01376, 01877, 01982 |
| Mid-Hudson Cable                 | 01376               |
| Mid-Rivers Communications        | 01376               |
| Mid-South Cablevision            | 01376, 01877, 01982 |
| Midamerican Cable Systems        | 01376, 01877, 01982 |
| Midcontinent Communications      | 01376, 01877, 01982 |

|                            |                     |
|----------------------------|---------------------|
| Midstate Communications    | 01376, 01877, 01982 |
| Midtel Cable TV            | 01376, 01877, 01982 |
| Milcom Cable               | 01376, 01877, 01982 |
| Milford Cable TV           | 01376, 01877, 01982 |
| Milk River Cable Club      | 01376, 01877, 01982 |
| Millennium Telecom         | 01481, 01998, 03028 |
| Millheim TV Transmission   | 01376, 01877, 01982 |
| Millington CATV            | 01376, 01877, 01982 |
| Minburn Communications     | 01481, 01998, 03028 |
| Minerva Valley Cable       | 01376, 01877, 01982 |
| MINET                      | 01877               |
| MLGC Cable TV              | 01376, 01877, 01982 |
| MM&G Enterprises           | 01481, 01998, 03028 |
| MMDS Wireless East         | 01376, 01877, 01982 |
| Mobius Communications      | 01376, 01877, 01982 |
| Monroe Cablevision         | 01376, 01877, 01982 |
| Monroe Utilities           | 01376, 01877, 01982 |
| Montana Opticom            | 01376, 01877, 01982 |
| Moosehead Enterprises      | 01376, 01877, 01982 |
| Morris Broadband           | 01376               |
| Morristown Utility Systems | 01877               |
| Mosaic Telecom             | 01376, 02586        |

|                                |   |
|--------------------------------|---|
| Motorola                       | 01376, 02437,<br>02378, 01998,<br>00858, 02952,<br>01562, 01982,<br>02401 |
| Moultrie<br>Telecommunications | 01376, 01877,<br>01982  |
| Mountain Shadows<br>Cable TV   | 01376, 01877,<br>01982  |
| Mountain<br>Telecommunications | 01376, 01877,<br>01982  |
| Mountain Zone TV               | 01376, 01877,<br>01982  |
| Movistar                       | 03288   |
| Moxi                           | 02187   |
| Mt. Baker Cable                | 01376, 01877,<br>01982  |
| MTC                            | 01376, 01877,<br>01982  |
| MTC Technologies               | 01376, 01982  |
| MTS                            | 01998   |
| Multiband Cable                | 01376, 01877,<br>01982  |
| Municipality Cable<br>Operator | 01376, 01877,<br>01982  |
| Murphy Cable                   | 01376, 01877  |
| Murray Electric System         | 01376, 01877,<br>01982  |
| Muscatine Power &<br>Water     | 01376   |
| N.W. Communications            | 01376, 01877,<br>01982  |
| National Cable                 | 01376, 01877,<br>01982  |
| Naujat Cooperative             | 01376, 01877,<br>01982  |
| NDTC                           | 01481, 01998,<br>03028  |
| Nebraska Central<br>Telecom    | 01376, 01877,<br>01982  |
| NEIT                           | 01376, 01877,<br>01982  |
| Nelson County<br>Cablevision   | 01376, 01877,<br>01982  |

|                                     |                        |
|-------------------------------------|------------------------|
| Nelsonville TV Cable                | 01376, 01877,<br>01982 |
| Nemont<br>Communications            | 01376, 01877           |
| NET                                 | 01883                  |
| New Century<br>Communication        | 01376, 01877,<br>01982 |
| New Day Broadband                   | 01376, 01877,<br>01982 |
| New England Cable                   | 01376, 01877,<br>01982 |
| New Jersey<br>Broadband             | 01376, 01877,<br>01982 |
| New Knoxville Cable<br>Systems      | 01376, 01877,<br>01982 |
| New North Networks                  | 01376, 01877,<br>01982 |
| New Paris Quality<br>Cablevision    | 01376, 01877,<br>01982 |
| New Visions<br>Communications       | 01376, 01877,<br>01982 |
| New Windsor Cable TV                | 01376, 01877,<br>01982 |
| Newcastle Cablevision               | 01376, 01877,<br>01982 |
| Newpath<br>Communications           | 01877, 01982           |
| NewWave<br>Communications           | 01376, 02187           |
| NexHorizon<br>Communications        | 01376, 01877,<br>01982 |
| Nexicom<br>Communications           | 01376, 01877,<br>01982 |
| Nextgen<br>Communications           | 01376, 01877           |
| Niagara Community<br>TV Cooperative | 01376, 01877,<br>01982 |
| Nimpkish Valley<br>Muncunations     | 01376, 01877,<br>01982 |
| Nittany Media                       | 01376                  |
| Nor-Cal Cable<br>Systems            | 01376, 01877,<br>01982 |
| Nortex<br>Communications            | 01376, 01877,<br>01982 |

|                                    |                        |
|------------------------------------|------------------------|
| North American<br>Communications   | 01376, 01877,<br>01982 |
| North Central<br>Telephone         | 02345                  |
| North Crossroads<br>Communications | 01376, 01877,<br>01982 |
| North Dakota<br>Telephone          | 02586                  |
| North Star Cablevision             | 01376, 01877,<br>01982 |
| North State<br>Communications      | 00858                  |
| North Texas<br>Broadband           | 01376, 01877,<br>01982 |
| North Yellowstone<br>Cable TV      | 01376, 01877,<br>01982 |
| Northern Cable<br>Holdings         | 01376, 01877,<br>01982 |
| Northern Lakes Cable<br>TV         | 01376, 01877,<br>01982 |
| Northland<br>Communications        | 01376                  |
| Northside TV                       | 01376, 01877,<br>01982 |
| Northstar Broadband                | 01376, 01982           |
| Northwest<br>Communications        | 01376, 01877,<br>01982 |
| Northwest Community                | 01877                  |
| Northwest Iowa<br>Telephone        | 01877                  |
| Northwest Telephone<br>Cooperative | 01376, 01877,<br>01982 |
| NorthwesTel                        | 01376                  |
| Norvado                            | 02586                  |
| Norwood Light<br>Broadband         | 01376                  |
| Nova Cable<br>Management           | 01376, 01877,<br>01982 |
| Nova Cablevision                   | 01376, 01877,<br>01982 |
| Novus                              | 01376, 01877           |
| NPG Cable                          | 01376                  |
| Nsight                             | 02345, 02586           |

|                      |                        |
|----------------------|------------------------|
| NTC Cable Services   | 01376, 01877,<br>01982 |
| nTelos               | 01998                  |
| NTL                  | 01060                  |
| NTS Communications   | 01376, 01877,<br>01982 |
| NU Telecom           | 01998, 03028           |
| NuLink               | 01877, 01376,<br>01982 |
| Numericable          | 02436                  |
| Nushagak Cooperative | 01376, 01877,<br>01982 |

#### ■ Cable Set Top Box (O to S)

|                              |                        |
|------------------------------|------------------------|
| Oak Cable Systems<br>Of Iowa | 01376, 01877,<br>01982 |
| Oak Hill Cablevision         | 01376, 01877,<br>01982 |
| Oasis Communications         | 01376, 01877,<br>01982 |
| Oi TV                        | 03452, 03454           |
| Omni III Cable TV            | 01376, 01877,<br>01982 |
| Oneida Cablevision           | 01376, 01877,<br>01982 |
| OneLink                      | 01376, 01877,<br>01982 |
| OneSource<br>Communications  | 01376                  |
| Ono                          | 01562                  |
| Open IPTV                    | 01615                  |
| Opp Cablevision              | 01376, 01877,<br>01982 |
| Optimum                      | 01877                  |
| Optimus Clix                 | 02437                  |
| Optus                        | 01060                  |
| Orange                       | 02407                  |
| Orbitel<br>Communications    | 01376                  |
| Oregon Cable Group           | 01376, 01877,<br>01982 |
| Orion Cablesystems           | 01376, 01877,<br>01982 |

|                                      |   |
|--------------------------------------|---|
| OTEC Communications                  | 02586   |
| Our Cable                            | 01376, 01877, 01982   |
| Overton County Cable                 | 01376, 01877, 01982   |
| Oxford Networks                      | 01376, 01877, 01982   |
| Pace                                 | 01877, 01060, 02620, 01982, 01582, 01376, 01883, 02401, 03454 |
| Packerland Broadband                 | 01376   |
| Paleajook Cooperative                | 01376, 01877, 01982   |
| Palmer Mutual Telephone              | 01376, 01877, 01982   |
| Palmetto Rural Telephone Cooperative | 00858   |
| Panasonic                            | 01982   |
| Pangnirtung Cooperative              | 01376, 01877, 01982   |
| Panhandle Telephone                  | 01376   |
| Panora Telecommunications            | 01481   |
| Paragould Light & Water              | 01376, 01877, 01982   |
| Parish Communications                | 01376, 01877, 01982   |
| Park Region Mutual Telephone         | 01481, 01998, 02345, 03028                                    |
| Park TV & Electronics                | 01376, 01877, 01982   |
| Partner Communications               | 01376, 01877, 01982   |
| Pathway Com-Tel                      | 01376, 01877, 01982   |
| Patterson Cable TV                   | 01376, 01877, 01982   |
| Paul Bunyan Communications           | 02586   |
| PBT Cable Services                   | 01376, 01877, 01982   |

|                                |                            |
|--------------------------------|----------------------------|
| PC One Cable                   | 01376, 01877, 01982        |
| PDQ Cable TV                   | 01376, 01877, 01982        |
| PEC Cablevision                | 01376, 01877, 01982        |
| Pegasus Communications         | 01376, 01877, 01982        |
| Peoples CATV                   | 01376, 01877, 01982        |
| Persona Communications         | 01376, 01877, 01982        |
| Philippi Communications        | 01376, 01877, 01982        |
| Philips                        | 01582, 02294               |
| Phoenix                        | 01376                      |
| Phoenix Cable                  | 01376, 01877, 01982        |
| Phonoscope Communications      | 01376, 01877, 01982        |
| Pickwick Cablevision           | 01376, 01877, 01982        |
| Piedmont Cable Services        | 01376, 01877, 01982        |
| Pine Bluff Cable               | 01376                      |
| Pine Island Telephone          | 01481, 01998, 03028        |
| Pine River Cable               | 01376, 01877, 01982        |
| Pine Tree Cablevision          | 01376, 01877, 01982        |
| Pineland Telephone Cooperative | 01481, 01615, 01898, 02586 |
| Pinpoint Communications        | 01376, 01877, 01982        |
| Pioneer                        | 01877                      |
| Pioneer Cable                  | 01376, 01877, 01982        |
| Pioneer Communications         | 01376, 01877, 01982        |
| Pioneer Long Distance          | 01898, 01615               |
| Pitcairn Community Cable TV    | 01376, 01877, 01982        |

|                                  |                     |
|----------------------------------|---------------------|
| Plantation Cable System          | 01376, 01877, 01982 |
| Pleasant Vision                  | 01376, 01877, 01982 |
| Polar Communications             | 02586               |
| Polaris Cable                    | 01376, 01877, 01982 |
| Ponderosa Cablevision            | 01376, 01877, 01982 |
| Poplar Bluff Municipal Utilities | 01481, 01998, 03028 |
| Portal Cablevision               | 01376, 01877, 01982 |
| Portugal Telecom                 | 02401               |
| Post Cablevision                 | 01376, 01877, 01982 |
| Premier Communications           | 01376               |
| Premiere                         | 02620               |
| Price County Telephone           | 01481, 01998, 03028 |
| Prime Cable Corporation          | 01376, 01877, 01982 |
| Prime Time Cable                 | 01376, 01877, 01982 |
| Princetown Cable                 | 01376, 01877, 01982 |
| Private Cable Systems            | 01376, 01877, 01982 |
| Private Network Cable Systems    | 01376, 01877, 01982 |
| Project Mutual Telephone         | 01481, 01998, 03028 |
| Project Services                 | 01376, 01877, 01982 |
| PSC                              | 01481, 01998, 03028 |
| PTCI                             | 01376               |
| PVT Networks                     | 01376, 01877, 01982 |
| Quality Cable TV                 | 01376, 01877, 01982 |
| Quality One Technologies         | 01481, 01998, 03028 |

|                             |                     |
|-----------------------------|---------------------|
| Quinter Cable               | 01376, 01877, 01982 |
| Qwerty.TV                   | 01898               |
| R & R Cable                 | 01376               |
| Raftview Communications     | 01376, 01877, 01982 |
| Rainbow Cable               | 01376, 01877, 01982 |
| Rainbow Communications      | 01376, 01877, 01982 |
| Rainbow Lake Cable TV       | 01376, 01877, 01982 |
| Rainier Connect             | 01376, 01877, 01982 |
| Ramapo Cable                | 01376, 01877, 01982 |
| Rancho Murieta Association  | 01376               |
| Randolph Telephone          | 02586               |
| Rapid Communications        | 01376, 01877, 01982 |
| RC Communications           | 01376, 01877, 01982 |
| RCN                         | 01376               |
| Reach Broadband             | 01376, 01877, 01982 |
| Readlyn Telephone           | 02586               |
| Rebeltec Communications     | 01376, 01877, 01982 |
| Red River Cable             | 01376, 01877, 01982 |
| Reds Cable TV               | 01376, 01877, 01982 |
| Regional Cable TV           | 01376, 01877, 01982 |
| Reinbeck Telecommunications | 01376, 01877, 01982 |
| Reservation Telephone       | 01376, 01998, 02345 |
| Reserve Long Distance       | 01376, 01877, 01982 |
| Resnet Communications       | 01376, 01877, 01982 |
| Resort Cable                | 01376               |

|                                    |                        |
|------------------------------------|------------------------|
| Reveille Broadband                 | 01376, 01877,<br>01982 |
| Reynolds Cable                     | 01376, 01877,<br>01982 |
| RGA Cablle                         | 01376, 01877,<br>01982 |
| Ridgewood<br>Cablevision           | 01376, 01877,<br>01982 |
| Ringgold Telephone                 | 01376, 01877,<br>01982 |
| Rio Virgin Telephone               | 01376, 01877,<br>01982 |
| Riondel Community<br>Cable Society | 01376, 01877,<br>01982 |
| Ripley Video Cable                 | 01376, 01877,<br>01982 |
| Ritter Cable                       | 01376, 01877,<br>01982 |
| River Road Cable                   | 01376, 01877,<br>01982 |
| River Valley Cable TV              | 01376, 01877,<br>01982 |
| River Valley<br>Telecommunications | 01481, 01998,<br>03028 |
| Riverside Cablevision              | 01376, 01877,<br>01982 |
| Riviera Cable TV                   | 01376, 01877,<br>01982 |
| Robins Cable TV                    | 01376, 01877,<br>01982 |
| Rock Port Cablevision              | 01376, 01877,<br>01982 |
| Rocky Mountain Cable<br>Systems    | 01376, 01877,<br>01982 |
| Rogers                             | 01877, 01376           |
| Roome<br>Telecommunications        | 01376, 01877,<br>01982 |
| Royal Telephone                    | 01376, 01877,<br>01982 |
| RTC                                | 01376, 01877,<br>01982 |
| RTEC<br>Communications             | 01376, 01877,<br>01982 |

|                                      |   |
|--------------------------------------|---|
| Runestone Telcom                     | 01376, 01877,<br>01982  |
| Rural Route Video                    | 01376, 01877,<br>01982  |
| Rural Telephone<br>Company           | 01376   |
| RuralWest                            | 01376, 01877,<br>01982  |
| Russellville Electric<br>Plant Board | 02586   |
| S & K TV Systems                     | 01376, 01877,<br>01982  |
| S & T Communications                 | 01376, 01877,<br>01982  |
| S-GO Video                           | 01877, 01982  |
| S.Bryer Cable TV                     | 01376, 01877,<br>01982  |
| Sagem                                | 02407, 02436,<br>03288  |
| Sagemcom                             | 02407, 02436,<br>03007  |
| Sallisaw Municipal<br>Authority      | 01376, 01877,<br>01982  |
| Samsung                              | 02407, 02015,<br>01877, 03477,<br>01060, 01987,<br>02589, 03265 |
| San Bruno Municipal<br>Cable TV      | 01376, 01877,<br>01982  |
| San Carlos<br>Cablevision            | 01376, 01877,<br>01982  |
| San Juan Cable                       | 01376, 01877,<br>01982  |
| San Simeon<br>Community Cable        | 01376, 01877,<br>01982  |
| Santel Comm<br>Cooperative           | 01376, 01877,<br>01982  |
| Sasktel                              | 01998   |
| Satellite Cable<br>Services          | 01376, 01877,<br>01982  |
| Satview Broadband                    | 01376, 01877,<br>01982  |
| Saugeen Telecable                    | 01376, 01877,<br>01982  |

|                                  |   |
|----------------------------------|---|
| Savage<br>Communications         | 01376, 01877,<br>01982  |
| Sayward Valley<br>Communications | 01376, 01877,<br>01982  |
| Schindler Cable TV               | 01376, 01877,<br>01982  |
| SCI Cable                        | 01376, 01877,<br>01982  |
| Scientific Atlanta               | 01877, 01982,<br>00858, 01987,<br>02401, 02436,<br>02345, 03028 |
| Scio Cablevision                 | 01376, 01877,<br>01982  |
| Scott Telecom And<br>Electronics | 01376, 01877,<br>01982  |
| Scottsboro Cable TV              | 01376, 01877,<br>01982  |
| Sea Island                       | 01877   |
| Seaside Cable TV                 | 01376, 01877,<br>01982  |
| Seaview<br>Communications        | 01376, 01877,<br>01982  |
| SecureVision                     | 01376, 01877,<br>01982  |
| Semo Communications              | 01376, 01877,<br>01982  |
| Senior TV                        | 01376, 01877,<br>01982  |
| Service Electric                 | 01376, 01877,<br>01982  |
| Service One Cable                | 01376, 01877,<br>01982  |
| Shannon Vision                   | 01376, 01877,<br>01982  |
| Shaw                             | 01376, 01877,<br>02187  |
| Shawano Municipal<br>Utilities   | 01376, 01877,<br>01982  |
| Shellsburg Cablevision           | 01376, 01877,<br>01982  |
| Shen-Heights TV                  | 01376, 01877,<br>01982  |

|                                  |                        |
|----------------------------------|------------------------|
| Shenandoah Cable                 | 01376, 01877,<br>01982 |
| Shenandoah<br>Telecommunications | 01376, 01877,<br>01982 |
| Shentel                          | 01376, 01877,<br>01982 |
| Sherburne Cable                  | 01376, 01877,<br>01982 |
| Sherman Cablevision              | 01376, 01877,<br>01982 |
| Shrewsbury Electric &<br>Cable   | 01376, 01877           |
| Silver Star<br>Communications    | 01481, 01998,<br>03028 |
| Simpson Country<br>Cable TV      | 01376, 01877,<br>01982 |
| SingTel                          | 01998                  |
| Siskiyou Cablevision             | 01376, 01877,<br>01982 |
| Sister Lakes Cable               | 01376, 01877,<br>01982 |
| Sjoberg's Cable TV               | 01376                  |
| Skisat                           | 01376, 01877,<br>01982 |
| SKT                              | 01376, 01877,<br>01982 |
| SKY                              | 02620                  |
| Sky Angel                        | 01376, 01877,<br>01982 |
| Sky Cablevision                  | 01376, 01877,<br>01982 |
| SKY Deutschland                  | 02620                  |
| Skyline Cable                    | 02586                  |
| SkyPix                           | 01481, 01998,<br>03028 |
| Sleepy Eye Telephone             | 02345                  |
| Small Town Cable                 | 01376, 01877,<br>01982 |
| Smile Content                    | 02437                  |
| Smithville                       | 02586                  |
| Sogetel                          | 01998                  |
| Somerfield Cable TV              | 01376, 01877,<br>01982 |
| Source Cable                     | 01376                  |

|                                  |                     |
|----------------------------------|---------------------|
| South Benton Cablevision         | 01376, 01877, 01982 |
| South Central Communications     | 01376, 01877, 01982 |
| South Holt Cablevision           | 01376, 01877, 01982 |
| South Slope Communications       | 01376, 01877, 01982 |
| Southeast Cable TV               | 01376, 01877, 01982 |
| Southern Cayuga County Cable     | 01376, 01877, 01982 |
| Southern Coastal Cable           | 01376, 01877, 01982 |
| Southern Kansas Telephone        | 01376               |
| Southern Plains Cable            | 01376, 01877, 01982 |
| Southern Vermont Cable           | 01376, 01982        |
| Southey Cable                    | 01376, 01877, 01982 |
| Southside TV                     | 01376, 01877, 01982 |
| Southwest MN Broadband           | 01376, 01877, 01982 |
| Southwestern Bell Video Services | 01376, 01877, 01982 |
| Spanish Fork                     | 01376, 01877, 01982 |
| Spencer Municipal Utilities      | 01376, 01877, 01982 |
| Spillway Cablevision             | 01376, 01877, 01982 |
| Spirit Broadband                 | 01376, 01877, 01982 |
| Spring Creek Cable               | 01376, 01877, 01982 |
| Springcom                        | 01376, 01877, 01982 |
| Springfield Cablevision          | 01376, 01877, 01982 |
| Springville Cable                | 01376, 01877, 01982 |

|                               |                     |
|-------------------------------|---------------------|
| St. George Island Cable       | 01376, 01877, 01982 |
| St. John Cable                | 01376, 01877, 01982 |
| Stanley Cablevision           | 01376, 01877, 01982 |
| Stanton Telecom               | 01376, 01877, 01982 |
| Star Cablevision              | 01376, 01877, 01982 |
| Starkville Cablevision        | 01376, 01877, 01982 |
| Starlight Communications      | 01376, 01877, 01982 |
| Starview Cable of Delaware    | 01376, 01877, 01982 |
| Starvision                    | 01376, 01877, 01982 |
| Starwest                      | 01376, 01877, 01982 |
| Stellar Communications        | 01376, 01877, 01982 |
| Stellar Private Cable Systems | 01376, 01877, 01982 |
| Stofa                         | 02015               |
| Stowe Cablevision             | 01376, 01877, 01982 |
| Strategic Technologies        | 01376, 01877, 01982 |
| Stubbs Communications         | 01376, 01877, 01982 |
| Suddenlink                    | 01877, 01376        |
| Summit Broadband              | 01376, 01877, 01982 |
| Summit Communications         | 01376, 01877, 01982 |
| Sumner Cable TV               | 01376, 01877, 01982 |
| Sun Country Cable             | 01376               |
| Sunrise Communications        | 01376, 01877, 01982 |
| Supercanal                    | 01376               |
| Superior Cable & Data         | 01376, 01877, 01982 |

|                      |                     |
|----------------------|---------------------|
| Supervision Cable TV | 01376, 01877, 01982 |
| SureWest             | 01481, 01998, 02586 |
| Surry Telephone      | 02586               |
| SWAT Cooperative     | 01481, 01998, 03028 |
| Sweetwater Cable TV  | 01376, 01877, 01982 |
| Swisher Telephone    | 02345               |

#### ■ Cable Set Top Box (T to Z)

|                       |                     |
|-----------------------|---------------------|
| T-Home                | 02132               |
| TA Communications     | 01376, 01877, 01982 |
| Taloga Cable          | 01376, 01877, 01982 |
| TAT Cablevision       | 01376, 01877, 01982 |
| Tbaytel               | 03028               |
| TCSI Huntsville       | 01376, 01877, 01982 |
| TCT                   | 01376, 01877, 01982 |
| TDS                   | 01376, 01877, 01982 |
| TDS Telecom           | 03028               |
| Technicolor           | 01982               |
| Tekstar Cablevision   | 01376, 01877, 01982 |
| Tel-Star Cablevision  | 01376, 01877, 01982 |
| Tele-Media            | 01376, 01877, 01982 |
| Tele-Services         | 01376, 01877, 01982 |
| Tele2                 | 00660               |
| Telecentro            | 01376               |
| Telecom Cable         | 01376, 01877, 01982 |
| Teledistribution Amos | 01376               |
| Telefonica            | 03288, 03028        |
| Telenet               | 01920, 03477        |

|                                    |                            |
|------------------------------------|----------------------------|
| Telepak Networks                   | 01376, 01877, 01982        |
| TelePartners                       | 01376, 01877, 01982        |
| Telerent Leasing Corporation       | 01376, 01877, 01982        |
| Telesat Systems                    | 01376, 01877, 01982        |
| Telewest                           | 01987                      |
| Telmex                             | 01376                      |
| Telsat Systems                     | 01376, 01877, 01982        |
| Telus                              | 03028                      |
| Templeton Telephone                | 01376, 01877, 01982        |
| TeNeT                              | 01898                      |
| Tesco Cable TV                     | 01376, 01877, 01982        |
| Texas Mid-Gulf Cablevision         | 01376                      |
| Thames Valley Communications       | 01376, 01877, 01982        |
| The Community Agency               | 01376                      |
| The Town of Mountain Village Cable | 01376, 01877, 01982        |
| Thomson                            | 01582, 01982, 03007, 02407 |
| Three River Digital Cable          | 01376, 01877, 01982        |
| Throckmorton Cablevision           | 01376, 01877, 01982        |
| TiftNet                            | 01376, 01877, 01982        |
| Time Warner                        | 01877, 01376, 02187        |
| Tip-Top Communications             | 01376, 01877, 01982        |
| TiVo                               | 03265                      |
| Tobacco Valley Communications      | 01376, 01877, 01982        |
| Tongue River Cable TV              | 01376, 01877, 01982        |
| Total Cable Service                | 01376                      |



|                               |                     |
|-------------------------------|---------------------|
| Touchet Valley Television     | 01376, 01877, 01982 |
| TP                            | 02407               |
| Trans-Video                   | 01376, 01877, 01982 |
| Trappers Loop Communications  | 01376, 01877, 01982 |
| Trenton Cable                 | 01376, 01877, 01982 |
| Tri-County Cable TV           | 01376               |
| TrioTel Communications        | 01376, 01877, 01982 |
| Troy Cablevision              | 01376               |
| Trust Cable TV                | 01376, 01877, 01982 |
| TruVista                      | 01376, 01877, 01982 |
| Tudjaat Cooperative           | 01376, 01877, 01982 |
| Tulalip Broadband             | 01376, 01877, 01982 |
| Tullahoma Utilities           | 02586               |
| Tulugak Cooperative           | 01376, 01877, 01982 |
| Turquoise Turtle TV           | 01376, 01877, 01982 |
| TV Cable                      | 01376               |
| TV Cable Company of Andalusia | 01376               |
| TV Cable of Winamac           | 01376, 01877, 01982 |
| TV Northeast                  | 01481, 01998, 03028 |
| TV Service                    | 01376, 01877, 01982 |
| TVB                           | 01615               |
| TVC                           | 01376, 01877, 01982 |
| TVision                       | 01376, 01877, 01982 |
| TVMAX                         | 01376, 01877, 01982 |
| TVS Cable                     | 01376, 01877, 01982 |

|                                   |                            |
|-----------------------------------|----------------------------|
| Twin Valley Communications        | 02586                      |
| Two Creeks Cable                  | 01376, 01877, 01982        |
| Ucluelet Video                    | 01376, 01877, 01982        |
| Uintah Basin Electronic Telecom   | 01376, 01877, 01982        |
| UMBC                              | 01376, 01877, 01982        |
| Union Telephone                   | 01376, 01877, 01982        |
| Unitah-Strata Networks            | 01376                      |
| United Communications Association | 01376                      |
| United States Gypsum              | 01376, 01877, 01982        |
| United Telephone                  | 01376, 02586               |
| Unitymedia                        | 03477                      |
| Universal Cablevision             | 01376, 01877, 01982        |
| Universal Satellite Cable         | 01376, 01877, 01982        |
| UPC                               | 01582, 03477, 00660, 01060 |
| UPC Cablecom                      | 01582, 03477               |
| Upper Peninsula Communications    | 01376, 01877, 01982        |
| US Online                         | 01376, 01877, 01982        |
| US Sonet                          | 01376, 01877, 01982        |
| USA Cablesystems                  | 01376, 01877, 01982        |
| USA Companies                     | 01376, 01877, 01982        |
| Utica Cablevision                 | 01376, 01877, 01982        |
| Utilities Board City of Foley     | 01376                      |
| Utility Systems Development       | 01376, 01877, 01982        |

|   |                     |
|---|---------------------|
| Uwharrie Communications                 | 02586               |
| Valley Cable & Satellite Communications | 01376, 01877, 01982 |
| Valley Cable TV                         | 01376, 01877, 01982 |
| Valparaiso Communications               | 01376               |
| Venture Communications Cooperative      | 01481, 01998, 03028 |
| Venus Telephone Cooperative             | 01376, 01898        |
| Veracity Communications                 | 01376, 01877, 01982 |
| Verizon                                 | 02378               |
| Vernon Telephone Cooperative            | 02586               |
| Vicksburg Video                         | 01376               |
| Videotron                               | 01877               |
| Vidia Communications                    | 01376, 01877, 01982 |
| Vidion Cable                            | 01376, 01877, 01982 |
| Viken Fibernett                         | 02437               |
| Viola Communications                    | 01376, 01877, 01982 |
| Virgin Media                            | 01987, 01060, 03265 |
| Vision Communications                   | 01376               |
| VisionComm                              | 01376, 01877, 01982 |
| Vital Communications                    | 01376, 01877, 01982 |
| Vivo                                    | 03288               |
| Vodafone                                | 02401               |
| Vogtmann Engineering                    | 01376, 01877, 01982 |
| Volcano Vision                          | 01376               |
| W.D.B. Communications                   | 01376, 01877, 01982 |
| Wabash Independent Networks             | 01376, 01877, 01982 |

|   |                     |
|---|---------------------|
| Wadsworth Cable TV                            | 01376               |
| Waitsfield Cable                              | 01376               |
| Walnut Communications                         | 01376, 01982        |
| Walnut Grove Cable TV                         | 01376, 01877, 01982 |
| Ward Communications                           | 01376, 01877, 01982 |
| Warwick Valley Telephone                      | 01376, 01877, 01982 |
| Washington County Rural Telephone Cooperative | 01376, 01877, 01982 |
| Watch TV                                      | 01481, 01998, 03028 |
| Waterville Cable TV                           | 01376, 01877, 01982 |
| Watson Cable                                  | 01376, 01877, 01982 |
| Wave Broadband                                | 01376               |
| Wavevision                                    | 01376, 01877, 01982 |
| WCTA  | 01376, 01877, 01982 |
| WEHCO Video                                   | 01376               |
| Weiss Lake Cable                              | 01376, 01877        |
| West Alabama TV Cable                         | 01376, 01877, 01982 |
| West Carolina Telephone                       | 03028               |
| West Central Telephone                        | 01376, 01877, 01982 |
| West Lake Cablevision                         | 01376, 01877, 01982 |
| West River Cable Television                   | 01376, 01877, 01982 |
| WesTel Systems                                | 01376, 01877, 01982 |
| Western Broadband                             | 01376, 01877, 01982 |
| Western Cable Service                         | 01376, 01877, 01982 |
| Western Iowa Telephone                        | 01877               |

|                                  |                     |
|----------------------------------|---------------------|
| Western Telephone Company        | 01376, 01877, 01982 |
| Western Wisconsin Communications | 01376, 02586        |
| Westman Communications           | 01376, 02187        |
| Westphalia Broadband             | 02586               |
| Wetherell Satellite Cable TV     | 01376, 01877, 01982 |
| WFL Cable Television             | 01376, 01877, 01982 |
| White County Video               | 01376               |
| WideOpenWest                     | 01376, 01877, 02187 |
| Wikstrom Systems                 | 01376, 01877, 01982 |
| Wilco Electronic Systems         | 01376, 01877, 01982 |
| Wilkes Telecommunications        | 01481, 01998, 03028 |
| Willamette Broadband             | 01376               |
| Windbreak Cable TV               | 01376, 01877, 01982 |
| Windjammer Cable                 | 01376, 01877        |
| Windom Communications            | 01877               |
| Windstream                       | 01376, 01982        |
| Winslow Communications           | 01376, 01877, 01982 |
| Wire Tele-View                   | 01376, 01877, 01982 |
| Wireless One                     | 01376, 01877, 01982 |
| Wittenberg Telephone             | 01376, 01877, 01982 |
| Wood County Telephone            | 01376, 01877, 01982 |
| Woodsfield Municipal Cable       | 01376, 01877, 01982 |
| Worth Cable TV                   | 01376, 01877, 01982 |
| WT Services                      | 01376, 01877, 01982 |

|                       |                            |
|-----------------------|----------------------------|
| WTC Communications    | 01376, 01877, 01982        |
| WTCL Cable            | 01376, 01877, 01982        |
| Wyandotte Municipal   | 01376, 01982               |
| Yadkin Valley Telecom | 02345                      |
| Ycom Networks         | 01376, 01877, 01982        |
| Yelcot Video Group    | 01376, 01877, 01982        |
| Yelo                  | 01376                      |
| Ygnition              | 01376, 01877, 01982        |
| Zampelli Electronics  | 01376, 01877, 01982        |
| Ziggo                 | 02589, 02015, 00660, 02401 |
| Zito Media            | 01376, 01982               |
| Zoom Media            | 01376, 01877, 01982        |

#### ■ Satellite Set top Box

|                     |                                   |
|---------------------|-----------------------------------|
| @sat                | 01300                             |
| Acoustic Solutions  | 01284                             |
| ADB                 | 00887                             |
| AEG                 | 02738, 02813                      |
| Agora               | 01284                             |
| Airis               | 02813                             |
| Airtel              | 02248                             |
| Akira               | 02738                             |
| Alba                | 01284, 02034                      |
| Altech UEC          | 02059                             |
| Amstrad             | 00847, 01662, 01175, 01693, 02467 |
| AMTC                | 02738, 02813                      |
| Arledge Electronics | 00775                             |
| Arnion              | 01300                             |
| ASDA                | 01284                             |
| AssCom              | 00853                             |
| Astro               | 01100, 02026                      |
| Aurora              | 00879                             |

|                                     |                            |
|-------------------------------------|----------------------------|
| Austar                              | 00879                      |
| Auvisio                             | 02738, 02813               |
| Avanit                              | 01631                      |
| Axil                                | 02738                      |
| Ballard Rural Telephone Cooperative | 00775                      |
| Bell                                | 00775                      |
| Bell Satellite TV                   | 00775                      |
| Biostek                             | 02738                      |
| Black Diamond                       | 01284                      |
| Boca                                | 02026, 02813               |
| Boshmann                            | 01631                      |
| Boxer                               | 02443, 01692               |
| BskyB                               | 01175, 00847, 01662        |
| Bulltech                            | 02738                      |
| Bush                                | 02376, 01284, 02034, 02813 |
| Cablecom                            | 01195, 01197               |
| Caiway                              | 02443, 00253               |
| Canal Digitaal                      | 00853, 02957               |
| Canal Digital                       | 00853                      |
| Canal+                              | 00853, 02657, 01195, 01197 |
| CanalSat                            | 00853, 02657               |
| Century                             | 00856                      |
| CGV                                 | 02034                      |
| Chess                               | 02026                      |
| Signal                              | 02835                      |
| City of Cawker City Cable           | 00775                      |
| CityCom                             | 01176                      |
| Claro                               | 03787, 03790               |
| Clatronic                           | 02738                      |
| Com Hem                             | 01176, 01915               |
| Comag                               | 02026, 02813               |
| Coship                              | 03787, 03790               |
| Country Vision Cable                | 00775, 00869               |
| Croner                              | 02813                      |
| Crown                               | 01284                      |
| Cyfra+                              | 00853, 01409               |

|                      |                     |
|----------------------|---------------------|
| Cyfrowy Polsat       | 00253, 0853, 01409  |
| D-box                | 01114               |
| DASAN                | 03321               |
| Delta                | 02443               |
| Denver               | 02738               |
| Deutsche Telekom     | 01195, 01197        |
| Dgtec                | 01631               |
| Dicra                | 02738               |
| Digi                 | 02026               |
| Digitality           | 02813               |
| Digihome             | 01284, 02034        |
| DigiLogic            | 01284, 02034        |
| DigiQuest            | 01300, 02738, 01631 |
| DigitAlb             | 01195, 01197        |
| DigitalBox           | 01631, 01100        |
| Digiwave             | 01631               |
| DirecTV              | 01377, 00099        |
| Dish Network         | 00775               |
| Dishpro              | 00775               |
| DishTV               | 01300               |
| DMT                  | 03321               |
| DMTech               | 02738               |
| DRE                  | 01176               |
| Dream Multimedia     | 01237, 01652, 01923 |
| DSE                  | 02813               |
| DSTV                 | 00879               |
| DTK Deutsche Telekom | 01195, 01197        |
| Dual                 | 02034               |
| Durabrand            | 01284, 02034        |
| Dyon                 | 02738, 02813        |
| Echostar             | 00775, 00853, 01409 |
| Edision              | 01631               |
| Elta                 | 02738               |
| Energy Sistem        | 01631, 02813        |
| Etisalat             | 02443               |
| Evesham Technology   | 02034               |

|                         |   |
|-------------------------|---|
| Finlux                  | 02034   |
| FinnSat                 | 01195, 01197  |
| Fortec Star             | 01631   |
| Foxtel                  | 01356, 00879, 01176   |
| Freesat                 | 01692, 02376  |
| Freesat+                | 02443   |
| Frontier Communications | 00775   |
| Fuji Onkyo              | 01631   |
| Galaxis                 | 00853, 00879  |
| General Instrument      | 00869   |
| General Satellite       | 01176   |
| Globo                   | 02026, 02957  |
| GoGen                   | 02738   |
| GOI                     | 00775   |
| Gold Box                | 00853   |
| Gold Vision             | 01631   |
| Goodmans                | 01284, 02376, 02034   |
| Gradiente               | 00887, 00856, 00099   |
| Grococ                  | 01409   |
| Grundig                 | 00847, 02376, 02034, 01284, 00853, 00879                      |
| Hanseatic               | 01100   |
| HD+                     | 02443   |
| HDT                     | 03321   |
| Hirschmann              | 02026   |
| Hitachi                 | 02034, 01284  |
| Hornet                  | 01300   |
| HTS                     | 00775   |
| Huawei                  | 03787   |
| Hughes Network Systems  | 01377   |
| Humax                   | 01176, 02443, 01808, 01915, 02408, 01377, 03321, 01989, 02616 |
| ibox                    | 01652   |

|                   |                            |
|-------------------|----------------------------|
| ID Digital        | 01176                      |
| Illusion          | 01631                      |
| Imagin            | 01195, 01197               |
| Imperial          | 01195, 01197               |
| Indovision        | 01989, 00856, 00887        |
| iNETBOX           | 01652, 01237               |
| Innova            | 00099                      |
| IQ                | 02813                      |
| ISkyB             | 00887                      |
| JVC               | 00775, 01284               |
| Kabel Deutschland | 01195, 01197               |
| KabelBW           | 01195, 01197, 01915        |
| KabelNoord        | 00253, 02443               |
| Kaon              | 01300                      |
| Kenwood           | 00853                      |
| Koenig            | 01631                      |
| KT                | 03321                      |
| Lava              | 01631                      |
| LG                | 03321                      |
| Linsar            | 01284                      |
| Lodos             | 01284                      |
| Logik             | 01284, 02034               |
| LogiSat           | 02026, 02813               |
| Luxor             | 02034                      |
| Macab             | 00853                      |
| Majestic          | 02738                      |
| Manhattan         | 01300                      |
| Maplin            | 02034                      |
| Marusys           | 03543                      |
| Mascom            | 02738                      |
| Matsui            | 01284                      |
| Maximum           | 02813                      |
| Mediabox          | 00853                      |
| MediaSat          | 00853                      |
| Mediascape        | 02835                      |
| Medion            | 02026                      |
| Mega TV           | 03321                      |
| MegaSat           | 02034, 02813, 01631, 02738 |

|                          |   |
|--------------------------|---|
| Metronic                 | 02738, 01631  |
| Micro                    | 02813   |
| Micro electronic         | 02813   |
| Milestone Communications | 00775   |
| Mitsai                   | 02738   |
| Morgan's                 | 02026   |
| Motorola                 | 00869, 00856, 03469   |
| Movistar                 | 01409   |
| Multichoice              | 00879, 02059, 02060   |
| Murphy                   | 02034   |
| Mysat                    | 02738   |
| NET                      | 01409   |
| Netsat                   | 00099, 00887  |
| Next Level               | 00869   |
| Nokia                    | 00853   |
| NPG                      | 01631   |
| NTV Plus                 | 01692, 02443  |
| Olleh TV                 | 03321   |
| Olleh-Skylife            | 03321   |
| Onn                      | 02034, 01284  |
| Opticum                  | 02957   |
| Optus                    | 00879, 01356  |
| Orbitech                 | 01100, 01195, 01197   |
| Orton                    | 02957   |
| Pace                     | 00847, 01356, 00887, 01175, 01693, 00853, 01662, 02467, 02657, 03469, 01377, 02059, 02060, 02211, 03787, 03790, 02620 |
| Pacific                  | 01284   |
| Palcom                   | 01409   |
| Palsonic                 | 02813   |
| Panasat                  | 00879   |
| Panasonic                | 00847   |

|                      |  |
|----------------------|--|
| Philips              | 00099, 00853, 01114, 02619, 00856, 00887, 02211, 03469               |
| Pioneer              | 00853  |
| PLDT                 | 02835  |
| Premiere             | 01114, 01195, 01197  |
| Primacom             | 01176, 01195, 01197  |
| Pro Basic            | 00853  |
| Proline              | 01284  |
| Qook TV              | 03321  |
| Qook-SkyLife         | 03321  |
| Qwest                | 01377  |
| RadioShack           | 00869  |
| Raduga TV            | 02957  |
| RiksTV               | 01692  |
| Roadstar             | 00853  |
| SAB                  | 01300, 01631   |
| Sagem                | 01692, 01114   |
| Sagemcom             | 01692  |
| Samsung              | 03063, 00253, 01377, 01989, 02467, 00853, 03321, 01662, 01693, 03834 |
| Sat Control          | 01300  |
| SAT+                 | 01409  |
| Satellite Operations | 00775  |
| Satplus              | 01100  |
| SatyCon              | 01631  |
| Schaub Lorenz        | 02034  |
| Schwaiger            | 01631, 02813, 02957  |
| Schwaiger CS         | 01631  |
| Scott                | 02738  |
| SEG                  | 01284, 02034   |
| Shark                | 01631  |
| Sharp                | 02034  |
| Shaw Direct          | 00869  |
| Sherwood             | 01409  |

|                 |   |
|-----------------|---|
| Shinelco        | 02738   |
| Sigmathek       | 02738, 02813  |
| SilverCrest     | 02026   |
| SKY             | 00856, 00847,<br>01662, 00887,<br>01175, 02619,<br>01693, 00099,<br>01114, 01377,<br>01915, 02467,<br>03469 |
| Sky Brasil      | 00856, 00887,<br>01377, 02619   |
| SKY Deutschland | 02443, 01114,<br>01915, 02620   |
| SKY Italia      | 01693, 02467,<br>00853, 01356   |
| SKY Mexico      | 00856, 02619,<br>00887, 01377,<br>03469   |
| SKY New Zealand | 02211   |
| SKY PerfecTV!   | 02616   |
| SkyCable        | 01631   |
| SkyLife         | 03321   |
| Skylink         | 02443, 02957  |
| Skymaster       | 01409   |
| Skyplus         | 02026, 01175  |
| SkySat          | 01100   |
| Skyworth        | 01631, 02835  |
| SL              | 02026   |
| SM Electronic   | 01409   |
| Smart           | 01631   |
| Sony            | 00847, 00853  |
| Star            | 00887   |
| Star Choice     | 00869   |
| Stream System   | 01300   |
| Strong          | 01409, 00879,<br>02813, 01300,<br>00853, 01284  |
| Sunny           | 01300   |
| Sunstech        | 02738   |
| Supernova       | 00887   |
| T-Mobile        | 02443   |

|                                     |  |
|-------------------------------------|--|
| TATA Sky                            | 03575  |
| TDS Telecom                         | 00775  |
| Teac                                | 02813  |
| Technicolor                         | 03469  |
| Technika                            | 01284, 02034                                   |
| TechniSat                           | 01195, 01197,<br>01100, 02813                  |
| Techwood                            | 01284, 02034                                   |
| tekComm                             | 02738  |
| TELE System                         | 01409, 02738,<br>02813                         |
| Tele2                               | 01195, 01197                                   |
| Telefonica                          | 01692, 01409                                   |
| Telestar                            | 01100, 01197,<br>01195                         |
| Televés                             | 01300  |
| Televiow<br>Communications          | 00775  |
| Televisa                            | 00887  |
| Telsey                              | 02738  |
| Telstra                             | 01356  |
| Telus                               | 00775  |
| Tevion                              | 01409, 02026,<br>02813                         |
| Thomson                             | 00847, 01175,<br>00853, 01662,<br>02619, 03469 |
| TNT SAT                             | 01692, 01195,<br>01197                         |
| Toshiba                             | 01284  |
| TrekStor                            | 02738  |
| Triangle<br>Communication<br>System | 00775  |
| Triax                               | 00853, 01631                                   |
| Tricolor TV                         | 01176  |
| True Visions                        | 02408  |
| TV Vlaanderen                       | 00853  |
| TVA Digital                         | 01692, 01409                                   |
| TVB                                 | 01989  |
| UEC                                 | 00879, 01356                                   |

|                                  |                       |
|----------------------------------|-----------------------|
| United Satellite<br>America      | 00775                 |
| United States Wireless           | 00775                 |
| Unitymedia                       | 01915                 |
| Unixbox                          | 01652                 |
| USA Wireless Satellite<br>TV     | 00775                 |
| Vectra                           | 01195, 01197          |
| Vestel                           | 01284, 02034          |
| Via Embratel                     | 03787                 |
| Viasat                           | 01197, 0253,<br>01195 |
| VisionNet                        | 01631                 |
| Viva                             | 00856                 |
| Vivo                             | 01409                 |
| Voom                             | 00869                 |
| VTC                              | 03834                 |
| Vu+                              | 03543                 |
| Walker                           | 02034, 01284          |
| Wharfedale                       | 02034                 |
| Windstream                       | 00775                 |
| Wisi                             | 02957                 |
| World Satellite Cable<br>Systems | 00775                 |
| Woxter                           | 02813, 02738          |
| Xoro                             | 02813                 |
| Xtreme                           | 01300                 |
| Yes                              | 00887, 01631          |
| Zehnder                          | 02034, 03469          |
| Zenith                           | 00856, 00253          |
| Ziggo                            | 02443                 |
| Zircon                           | 02957                 |
| <b>■ Video - Accessory</b>       |                       |
| A.C.Ryan                         | 02709, 03350          |
| ABS                              | 01272                 |
| Acer                             | 01272                 |
| Alienware                        | 01272                 |
| Apple                            | 02615                 |
| Boxee                            | 03693                 |
| Claritas                         | 01272                 |

|                  |              |
|------------------|--------------|
| CyberPower       | 01272        |
| D-Link           | 03693        |
| Daily Media      | 01272        |
| Dell             | 01272        |
| Digitech         | 02260        |
| Elonex           | 01272        |
| Eminent          | 02260        |
| Emtec            | 02709        |
| Fantec           | 02709        |
| Fujitsu Siemens  | 01272        |
| Gateway          | 01272        |
| Hewlett Packard  | 01272        |
| hFX              | 01272        |
| Howard Computers | 01272        |
| Hush             | 01272        |
| iBUYPOWER        | 01272        |
| iconBIT          | 02709, 03350 |
| ISTAR            | 02260        |
| Linksys          | 01272        |
| Mede8er          | 02709        |
| Media Center PC  | 01272        |
| Microsoft        | 01272, 01805 |
| Mind             | 01272        |
| NiveusMedia      | 01272        |
| Northgate        | 01272        |
| Packard Bell     | 01272        |
| Philips          | 01272        |
| PopBox           | 02260        |
| Popcorn Hour     | 02260        |
| Ricavision       | 01272        |
| Roku             | 03061        |
| Sony             | 02713, 01272 |
| Stack 9          | 01272        |
| Systemax         | 01272        |
| Tagar Systems    | 01272        |
| Toshiba          | 01272        |
| Touch            | 01272        |
| Trust            | 01272        |
| VIA Technologies | 01272        |
| Viewsonic        | 01272        |
| Voodoo           | 01272        |

|                 |              |
|-----------------|--------------|
| Western Digital | 02558        |
| Woxter          | 02709        |
| Xbox            | 01805, 01272 |
| ZT Group        | 01272        |

#### ■ CD

|                           |              |
|---------------------------|--------------|
| Advantage                 | 70032        |
| AH!                       | 70157        |
| Aiwa                      | 70157        |
| Arcam                     | 70157        |
| Atoll Electronique        | 70157        |
| Audio Research            | 70157        |
| Audiolab                  | 70157        |
| Audiomeca                 | 70157        |
| Audioton                  | 70157        |
| AVI                       | 70157        |
| Balanced Audio Technology | 70157        |
| Cairn                     | 70157        |
| California Audio Labs     | 70029, 70303 |
| Cambridge                 | 70157        |
| Cambridge Audio           | 70157        |
| Carver                    | 70157        |
| CCE                       | 70157        |
| Cyrus                     | 70157        |
| Denon                     | 70766        |
| DKK                       | 70000        |
| DMX Electronics           | 70157        |
| Dynaco                    | 70157        |
| Genexxa                   | 70032, 70000 |
| Goldmund                  | 70157        |
| Grundig                   | 70157        |
| Harman/Kardon             | 70157        |
| Hitachi                   | 70032        |
| Integra                   | 71817        |
| JVC                       | 70072        |
| Kenwood                   | 70157, 70036 |
| Krell                     | 70157        |
| Linn                      | 70157        |
| Loewe                     | 70157        |

|                 |              |
|-----------------|--------------|
| Magnavox        | 70157        |
| Marantz         | 70157, 70029 |
| Matsui          | 70157        |
| MCS             | 70029        |
| Memorex         | 70032        |
| Meridian        | 70157        |
| Micromega       | 70157        |
| Miro            | 70000        |
| Mission         | 70157        |
| Myryad          | 70157        |
| NAD             | 70721, 70000 |
| Naim            | 70157        |
| NSM             | 70157        |
| Onkyo           | 71817        |
| Optimus         | 70032, 70000 |
| Panasonic       | 70303, 70029 |
| Philips         | 70157        |
| Pioneer         | 70032        |
| Polk Audio      | 70157        |
| Primare         | 70157        |
| Proton          | 70157        |
| QED             | 70157        |
| Quad            | 70157        |
| Quasar          | 70029        |
| Radiola         | 70157        |
| RCA             | 70032        |
| Restek          | 70157        |
| Revox           | 70157        |
| Rotel           | 70157        |
| SAE             | 70157        |
| Sansui          | 70157        |
| SAST            | 70157        |
| Siemens         | 70157        |
| Silsonic        | 70036        |
| Simaudio        | 70157        |
| Sonic Frontiers | 70157        |
| Sony            | 70000, 70490 |
| Sylvania        | 70157        |
| TAG McLaren     | 70157        |
| Tandy           | 70032        |

|             |                     |
|-------------|---------------------|
| Tascam      | 73095, 73511, 73533 |
| Teac        | 73531, 73532, 73551 |
| Technics    | 70303, 70029        |
| Thorens     | 70157               |
| Thule Audio | 70157               |
| Universum   | 70157               |
| Victor      | 70072               |
| Wards       | 70032, 70000, 70157 |
| Yamaha      | 70036, 70032, 70490 |
| Zonda       | 70157               |

#### ■ Cassette Deck

|               |              |
|---------------|--------------|
| Aiwa          | 40029        |
| Arcam         | 40076        |
| Audiolab      | 40029, 40229 |
| Carver        | 40029        |
| Denon         | 40076        |
| Grundig       | 40029        |
| Harman/Kardon | 40029        |
| Inkel         | 40070        |
| JVC           | 40244        |
| Kenwood       | 40070        |
| Magnavox      | 40029        |
| Marantz       | 40029        |
| Myryad        | 40029        |
| Onkyo         | 42157        |
| Optimus       | 40027        |
| Panasonic     | 40229        |
| Philips       | 40029, 40229 |
| Pioneer       | 40027        |
| Polk Audio    | 40029        |
| Radiola       | 40029        |
| RCA           | 40027        |
| Revox         | 40029        |
| Sansui        | 40029        |
| Sony          | 40243, 40170 |
| Tascam        | 73095        |

|          |              |
|----------|--------------|
| Technics | 40229        |
| Thorens  | 40029        |
| Victor   | 40244        |
| Wards    | 40027, 40029 |
| Yamaha   | 40097        |

#### ■ Audio - Accessory

|            |                     |
|------------|---------------------|
| Apple      | 81115               |
| Jamo       | 82228               |
| Onkyo      | 81993, 82351, 82990 |
| Polk Audio | 82228               |

#### ■ Receiver

|         |       |
|---------|-------|
| Integra | 52503 |
| Onkyo   | 52503 |

#### ■ Cable PVR Combination

|                           |                     |
|---------------------------|---------------------|
| Access Communications     | 01376, 01877        |
| Adams Cable TV            | 01376               |
| ADB                       | 01920               |
| Armstrong                 | 01376, 01877        |
| Arris                     | 02187               |
| Atlantic Broadband        | 01877               |
| ATMC                      | 01376               |
| Bend Broadband            | 02187               |
| Blue Ridge Communications | 01877               |
| Bright House              | 01877, 01376        |
| Buckeye Cable System      | 01376, 01877, 02187 |
| Cable Axion Digitel       | 01376               |
| Cable One                 | 01376, 01877        |
| Cablecom                  | 01582               |
| Cablevision               | 01877, 01376        |
| Cablevision du Nord       | 01376               |
| CCAP                      | 01877               |
| Charter                   | 01376, 01877, 02187 |

|                             |   |
|-----------------------------|---|
| Cincinnati Bell             | 01877, 01376                                    |
| Cisco                       | 01877, 02589, 01982, 01582, 01883, 02401, 03265 |
| Citycable                   | 03477   |
| Cogeco                      | 01376, 01877, 01982                             |
| Comcast                     | 01376, 01877, 01982, 02187                      |
| Cox                         | 01877, 01376                                    |
| Darty Box                   | 02436   |
| Digeo                       | 02187   |
| Freebox                     | 01976   |
| Grande Communications       | 01877, 01376                                    |
| Humax                       | 02620, 02165                                    |
| ImOn Communications         | 01877   |
| Insight                     | 01376, 01877                                    |
| Inter Mountain Cable        | 01877   |
| Kabel Deutschland           | 02165   |
| Knology                     | 01877   |
| Mediacom                    | 01376, 01877                                    |
| MetroCast Cablevision       | 01877   |
| Midcontinent Communications | 01376, 01877                                    |
| Motorola                    | 01376   |
| Moxi                        | 02187   |
| NET                         | 01883   |
| NorthwesTel                 | 01376   |
| Novus                       | 01376, 01877                                    |
| Numericable                 | 02436   |
| Pace                        | 01877, 02620, 01582, 01883                      |
| Panasonic                   | 01982   |
| Philips                     | 01582   |
| Pioneer                     | 01877   |
| RCN                         | 01376   |
| Rogers                      | 01877, 01376                                    |
| Sagem                       | 02436   |

|                        |                                   |
|------------------------|-----------------------------------|
| Samsung                | 03477, 01877, 01987, 02589, 03265 |
| Scientific Atlanta     | 01877, 01982, 01987, 02436, 02401 |
| Service Electric       | 01376, 01877                      |
| Shaw                   | 01376, 01877, 02187               |
| SKY                    | 02620                             |
| SKY Deutschland        | 02620                             |
| Source Cable           | 01376                             |
| Suddenlink             | 01877, 01376                      |
| Telenet                | 01920, 03477                      |
| Telewest               | 01987                             |
| Thomson                | 01582                             |
| Time Warner            | 01877, 01376, 02187               |
| TiVo                   | 03265                             |
| Unitymedia             | 03477                             |
| UPC                    | 01582, 03477                      |
| UPC Cablecom           | 01582, 03477                      |
| Videotron              | 01877                             |
| Virgin Media           | 01987, 03265                      |
| Wave Broadband         | 01376                             |
| Western Iowa Telephone | 01877                             |
| Westman Communications | 01376, 02187                      |
| WideOpenWest           | 01877, 01376, 02187               |
| Ziggo                  | 02589                             |

#### ■ IPTV

|         |                                   |
|---------|-----------------------------------|
| ADB     | 02586, 01481, 01998, 03028        |
| Alcom   | 02437                             |
| Altibox | 02437                             |
| Amino   | 01615, 01481, 01898, 01998, 03028 |

|                                     |                            |
|-------------------------------------|----------------------------|
| Arkwest                             | 01481, 01998               |
| Arvig Communication Systems         | 01998, 02345               |
| AT&T                                | 00858                      |
| ATMC                                | 01998, 03028               |
| Ballard Rural Telephone Cooperative | 02586                      |
| Bayland Communications              | 02586                      |
| Bell                                | 01998                      |
| Bell Aliant                         | 01998                      |
| Bell Fibe TV                        | 01998                      |
| Bledsoe Telephone Cooperative       | 01481, 01998               |
| Bloomingdale Communications         | 01481, 01998, 03028        |
| Blue Valley Telecommunications      | 01898                      |
| Bouygues Telecom                    | 03007                      |
| Brandenburg Telecom                 | 01481, 01998               |
| BT                                  | 02294                      |
| BTC Broadband                       | 02586                      |
| Burlington Telecom                  | 01481, 01615               |
| Cabovis                             | 02436                      |
| CalTel Connections                  | 02586                      |
| Canby Telcom                        | 01481                      |
| Cannon Valley Cablevision           | 01481, 01998               |
| CenturyLink                         | 01998                      |
| Cisco                               | 00858, 03028, 02345, 02378 |
| ClubInternet                        | 02132                      |
| CoopTel                             | 00858, 01615, 01898        |
| CRST Telephone Authority            | 01481, 01998               |
| Dakota Central Telecommunications   | 02345                      |
| Dalton Cable Television             | 01877, 01982               |
| Delta Cable                         | 01376                      |

|                                |                     |
|--------------------------------|---------------------|
| Diverse Communications         | 01898               |
| Du                             | 02401               |
| Eagle Broadband                | 01481, 01998        |
| Eagle Valley Telephone         | 01481, 01998        |
| EasyTEL                        | 01481, 01998, 03028 |
| Echostar                       | 03452               |
| Etex                           | 02586               |
| Farmer's Telephone Cooperative | 01998, 03028        |
| Golden Belt Telephone          | 02586               |
| Gorham Communications          | 01481               |
| Griswold Cooperative Telephone | 01481, 01998        |
| GTI                            | 01481, 01998, 03028 |
| Harrisonville Telephone        | 02586               |
| Hathw@y                        | 02043               |
| Horizon Cable TV               | 02586               |
| Hotwire                        | 02586               |
| HTC Communications             | 01481, 01998        |
| Innovative Systems             | 01898               |
| Inotel                         | 02437               |
| Integra Telecom                | 02345               |
| Interstate Cablevision         | 01481, 01998        |
| JP PTT                         | 01615               |
| Kiss                           | 02132               |
| KM Telecom                     | 01481               |
| KoolConnect                    | 01481               |
| KPN                            | 02952, 02437        |
| Lakeland Cablevision           | 01481, 01998        |
| Lemonweir Valley Telephone     | 01481, 01998        |
| Liberty Communications         | 02586               |
| Lonsdale Video Ventures        | 01481, 01998        |
| Lumos Networks                 | 01998, 03028        |
| Manawa Telecom                 | 02586               |

|                                  |   |
|----------------------------------|---|
| Manti Telecom                    | 01481, 01998                            |
| Matanuska Telephone Association  | 01481, 02586                            |
| Meo                              | 02401                                   |
| MHTC                             | 01481, 01998                            |
| Microwave Satellite Technologies | 01481, 01998                            |
| Millennium Telecom               | 01481, 01998                            |
| Minburn Communications           | 01481, 01998, 03028                     |
| MM&G Enterprises                 | 01481, 01998                            |
| Motorola                         | 02378, 01998, 02437, 0858, 02952, 01376 |
| Movistar                         | 03288                                   |
| MTS                              | 01998                                   |
| NDTC                             | 01481, 01998, 03028                     |
| North Central Telephone          | 02345                                   |
| North Dakota Telephone           | 02586                                   |
| North State Communications       | 00858                                   |
| Norvado                          | 02586                                   |
| Nsight                           | 02345, 02586                            |
| NU Telecom                       | 01998, 03028                            |
| Oi TV                            | 03452, 03454                            |
| Open IPTV                        | 01615                                   |
| Optimus Clix                     | 02437                                   |
| Orange                           | 02407                                   |
| OTEC Communications              | 02586                                   |
| Pace                             | 02401, 03454                            |
| Panora Telecommunications        | 01481                                   |
| Paul Bunyan Communications       | 02586                                   |
| Pine Island Telephone            | 01481, 01998                            |
| Polar Communications             | 02586                                   |
| Poplar Bluff Municipal Utilities | 01481, 01998                            |

|                                 |                     |
|---------------------------------|---------------------|
| Portugal Telecom                | 02401               |
| Price County Telephone          | 01481, 01998        |
| Project Mutual Telephone        | 01481, 01998        |
| PSC                             | 01998               |
| Quality One Technologies        | 01481, 01998        |
| Qwerty.TV                       | 01898               |
| Randolph Telephone              | 02586               |
| Readlyn Telephone               | 02586               |
| Reservation Telephone           | 01998, 02345        |
| River Valley Telecommunications | 01481, 01998        |
| S-GO Video                      | 01877               |
| Sagem                           | 02407, 03288        |
| Sagemcom                        | 02407               |
| Samsung                         | 02407               |
| Sasktel                         | 01998               |
| Scientific Atlanta              | 00858, 02345, 03028 |
| Silver Star Communications      | 01481, 01998, 03028 |
| SingTel                         | 01998               |
| SKY Deutschland                 | 02620               |
| Skyline Cable                   | 02586               |
| SkyPix                          | 01481, 01998        |
| Smile Content                   | 02437               |
| Smithville                      | 02586               |
| Sogetel                         | 01998               |
| SureWest                        | 01481, 01998, 02586 |
| Surry Telephone                 | 02586               |
| SWAT Cooperative                | 01481, 01998, 03028 |
| T-Home                          | 02132               |
| Telefonica                      | 03288, 03028        |
| Telus                           | 03028               |
| TeNeT                           | 01898               |
| Thomson                         | 03007, 02407        |
| TV Northeast                    | 01481, 01998        |
| TVB                             | 01615               |

|                                    |              |
|------------------------------------|--------------|
| Twin Valley Communications         | 02586        |
| United Telephone                   | 02586        |
| Venture Communications Cooperative | 01998        |
| Verizon                            | 02378        |
| Viken Fibernet                     | 02437        |
| Vivo                               | 03288        |
| Watch TV                           | 01481, 01998 |
| West Carolina Telephone            | 03028        |
| Western Wisconsin Communications   | 02586        |
| Westphalia Broadband               | 02586        |
| Wilkes Telecommunications          | 01481, 01998 |
| Yadkin Valley Telecom              | 02345        |

#### ■ IPTV PVR Combination

|                  |                                   |
|------------------|-----------------------------------|
| ADB              | 02437                             |
| Altibox          | 02437                             |
| Amino            | 01615, 01898                      |
| AT&T             | 00858                             |
| ATMC             | 03028                             |
| Beeline          | 03028                             |
| Belgacom TV      | 02132                             |
| Bell             | 01998                             |
| Bell Aliant      | 01998                             |
| Bell Fibe TV     | 01998                             |
| Bouygues Telecom | 03007                             |
| BT               | 02294                             |
| Cabovis          | 02436                             |
| CenturyLink      | 01998                             |
| Cisco            | 00858, 03028, 02132, 02345, 02378 |
| ClubInternet     | 02132                             |
| Deutsche Telekom | 02132                             |
| Du               | 02401                             |
| Echostar         | 03452                             |

|                    |  |
|--------------------|--|
| Freebox            | 01976                                    |
| i-CAN              | 02437                                    |
| Innovative Systems | 01898                                    |
| InviTV             | 02437                                    |
| Kiss               | 02132                                    |
| KPN                | 02952, 02437                             |
| Lumos Networks     | 01998                                    |
| Magio Sat          | 02132                                    |
| Magnet             | 01615                                    |
| Meo                | 02401                                    |
| Motorola           | 02437, 02378, 00858, 01998, 02952, 02401 |
| MTS                | 01998                                    |
| Numericable        | 02436                                    |
| Oi TV              | 03452, 03454                             |
| Orange             | 02407                                    |
| Pace               | 02401, 03454                             |
| Philips            | 02294                                    |
| Portugal Telecom   | 02401                                    |
| Sagem              | 02407, 03288                             |
| Sagemcom           | 02436, 02407, 03007                      |
| Samsung            | 02407                                    |
| Sasktel            | 01998                                    |
| Scientific Atlanta | 00858, 02345, 02401, 03028               |
| SKY Deutschland    | 02620                                    |
| SureWest           | 01998                                    |
| T-Home             | 02132                                    |
| Telefonica         | 03028, 03288                             |
| Telus              | 03028                                    |
| Thomson            | 03007                                    |
| Verizon            | 02378                                    |
| Vodafone           | 02401                                    |

#### ■ PVR

|           |       |
|-----------|-------|
| DirecTV   | 20739 |
| Humax     | 20739 |
| Panasonic | 20616 |
| Philips   | 20739 |

|            |              |
|------------|--------------|
| RCN        | 20739        |
| ReplayTV   | 20616        |
| Sonic Blue | 20616        |
| Sony       | 20636        |
| TiVo       | 20739, 20636 |



# ONKYO

## Onkyo Corporation

Kitahama Chuo Bldg, 2-2-22 Kitahama, Chuo-ku, OSAKA 541-0041, JAPAN

<http://www.onkyo.com/>

## The Americas

### Onkyo U.S.A. Corporation

18 Park Way, Upper Saddle River, N.J. 07458, U.S.A.

For Dealer, Service, Order and all other Business Inquiries:

Tel: 201-785-2600 Fax: 201-785-2650

<http://www.us.onkyo.com/>

For Product Support Team Only:

1-800-229-1687

## Europe

### Onkyo Europe Electronics GmbH

Liegnitzerstrasse 6, 82194 Groebenzell, GERMANY

Tel: +49-8142-4401-0 Fax: +49-8142-4208-213

<http://www.eu.onkyo.com/>

### Onkyo Europe Electronics GmbH (UK Branch)

Meridien House, Ground floor, 69 - 71 Clarendon Road, Watford, Hertfordshire, WD17 1DS, United Kingdom

Tel: +44 (0)8712-00-19-96 Fax: +44 (0)8712-00-19-95

## China

### Onkyo China Limited (Hong Kong)

Unit 1033, 10/F, Star House, No 3, Salisbury Road, Tsim Sha Tsui Kowloon, Hong Kong.

Tel: 852-2429-3118 Fax: 852-2428-9039

<http://www.hk.onkyo.com/>

### Onkyo China PRC (Mainland)

1301, 555 Tower, No.555 West NanJing Road, Jing'an District, Shanghai, China 200041,

Tel: 86-21-52131366 Fax: 86-21-52130396

<http://www.cn.onkyo.com/>

## Asia, Oceania, Middle East, Africa

Please contact an Onkyo distributor referring to Onkyo SUPPORT site.

<http://www.intl.onkyo.com/support/>

The above-mentioned information is subject to change without prior notice.

Visit the Onkyo web site for the latest update.

SN 29401761PDF\_EN

(C) Copyright 2014 Onkyo Corporation Japan. All rights reserved.

D1403-0



\* 2 9 4 0 1 7 6 1 \*