







# The Digital Photography SourceBook

# Section 6

## CAMERA SUPPORT

Acratech.....406

Benbo .....407

Cullman .....408-409

Giottos.....410-411

Gitzo .....412-419

Manfrotto .....420-437

Slik.....438-447

Sunpak .....448-449

Tiltall.....450

Velbon .....451-455

Wimberly .....456-457

Obtaining information and ordering from B&H is quick and easy. When you call us, just punch in the corresponding Quick Dial number anytime during our welcome message. The Quick Dial code then directs you to the specific professional sales associates in our order department.

 For Section 6, Tripods  
use Quick Dial #: 73

## ULTIMATE BALLHEADS

The Acratech Ultimate Ballhead is the most efficient design ever created for combining low mass with incredible stopping power. Available with or without an installed Arca-type quick release clamp, it is an ideal head for those that don't need the progressive tension control of the heavier (and more expensive) Arca-Swiss B1. It can be combined with a Wimberley Sidekick to give exceptional gimbal-type control of all but the most gargantuan 35mm and medium format super telephoto lenses.

The Ultimate Ball Head will hold more weight more securely than ball heads many times its size. It is designed to hold digital, 35mm, medium format and smaller large format cameras securely in any position, and has been tested to hold 25 lbs. in any position. Tripod connection thread is 3/8"-16, and includes a reducer bushing so it will also fit 1/4"-20 threads and all standard camera tripods.

All components are precision C.N.C. (computer-numerically controlled) machined from solid stock and all structural components are machined from aircraft 6061-T6 aluminum. All threaded fasteners are machined from stainless steel and all bearing surfaces are machined from a special copolymer similar to Teflon.



### FEATURES

- ◆ Solid precision feel, absolutely no migration after tightening the clamp
- ◆ Silky-smooth black anodized finish for precise positioning
- ◆ Fully captive controls will not come off from prolonged vibrations
- ◆ Open design facilitates quick maintenance
- ◆ Calibrated panning bed
- ◆ "Dry" ball does not attract dirt or dust
- ◆ Full movements allow any camera position
- ◆ Compatible with Kirk, Arca, R.R.S., and many other QR plates
- ◆ Fits all standard tripods (1/4"-20 and 3/8"-16 threads)
- ◆ Weighs less than 1 lb. with quick release clamp, easily holds over 25 lbs. at any angle.

**Ultimate Ballhead 1112 (ACUBHKML):**  
With Left Metal Knobs & 3/8"-16 Screw, no quick release .....**219.95**

**Ultimate Ballhead 1115 (ACUBHQKRLDLP):**  
Left controls all rubber knobs, detent pin on clamp.....**299.95**

**Ultimate Ballhead 1116 (ACUBHKRL):**  
No clamp, rubber main and pan knob .**239.95**

**Leveling Base #1117 (ACLB):**  
Levels the bottom of your ballhead for panoramic photography. 3/8" tripod thread, supports 25 lbs. ....**149.95**

**V2 Ballhead #1118 with Arca-Style Quick Release (ACV2BH):** All rubber knobs with detent pin on quick release clamp .....**329.95**

**Ultimate Ballhead #1130 with Quick Release (ACUBHQKRRQ):** Rubber main control knob on the right side.....**289.95**

**New! GV2 Ballhead:**  
Has a gimbal feature for telephoto lenses up to 400mm. All rubber knobs with detent pin on quick release clamp.....**Call**

## CLAMPS & PLATES

**1142 Arca-Type Quick Release Clamp (ACQRCKRDTP):** With 3/8"-16 threaded hole.....**99.95**

**2128 Arca-Type Quick Release Clamp (ACQRPCT14):** 1/4-20" generic with cork top.....**39.95**



**2129 Arca-Type Quick Release Plate (ACQRPCT38):** With 3/8"-16 generic with cork top .....**39.95**

**2130 Arca-Type Quick Release Plate (ACQRLP2.5):** 2-1/2" (63mm) lens plate..**39.95**

**2131 Arca-Type Quick Release Plate (ACQRLP4):** 4" (101mm) lens plate.....**44.95**

**2138 Arca-Type Quick Release Plate (ACQRPE7):** Canon 10D (without grip); Nikon D100 & D200 (without grip).....**39.95**

**2143 Arca-Type Quick Release Plate (ACQRPH38):** For Hasselblad.....**39.95**

**2158 Arca-Type Quick Release Plate (ACQRPN2H):** For Nikon D2H, D2x.....**39.95**

**2159 Arca-Type Quick Release Plate (ACQRPCDR):** For Canon EOS-30D, Digital Rebel, Digital Rebel XT/XTi .....**39.95**



## TRIPODS

Stability linked to versatility and weight are the prime considerations when choosing a tripod. For over 35 years Benbo tripods have offered photographers a unique combination of these factors.

The tubular aluminium construction of the legs offers the best possible combination of weight and rigidity. Each leg can be independently positioned, made possible by the tripods unique, highly flexible main joint, which enables each leg to swing through a complete 360°.

The center column can also be swung through 360°, producing a combination that allows the camera to be positioned at almost any point. Whether used in the standard configuration with a vertical center column, down at ground level with legs splayed out, or with one of the legs pointing upward finding support from a tree or wall, Benbo tripods can always be relied upon to give complete stability. All models are constructed from drawn tubing with no internal seams, with the lower tubing having sealed feet, allowing the tripod to be stood in water, mud or snow up to the leg joint.

### Classic No 1 & 2 Tripods

These heavy-duty tripods offer great stability and are capable of supporting the heaviest of camera equipment. They are both constructed from the same tough aluminium tubing, with the No 2 tripod offering extra height with its longer legs. The double ended center column offers a choice of standard 3/8" or 1/4" fixing for ball & socket heads.

### Trekker Mk 2

Benbo's most versatile tripod, the swivel joint at the top of the center column can be fully adjusted through 180° offering even more flexibility when positioning the camera. This feature makes the Trekker MK2 ideal when subjects need to be photographed from above or at a low angle. The Trekker MK2 supports the majority of today's digital SLR cameras. However stability is directly related to weight and the provision of a hook at the lower end of the center column, allows the temporary addition of extra weight (e.g. a camera bag) to give greater stability when long lenses are in use on the camera.

### Mini Trekker

All the features of the Trekker Mk2 but with shorter fixed length legs. This lightweight compact tripod is ideal for use when photographing flowers and other low-level nature subjects, or indoors as a tabletop tripod.

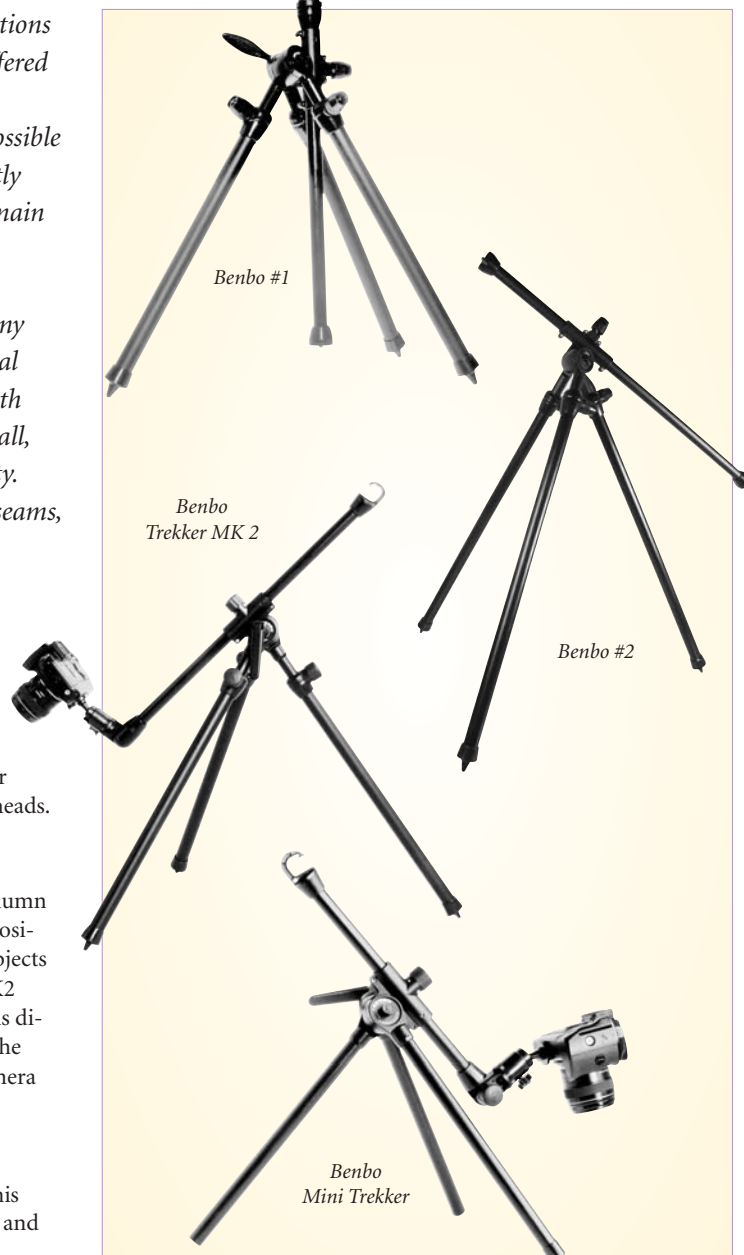

### BENBO TRIPOD SPECIFICATIONS

	SKU	Extends to	Closes To	Weight	Price
Benbo 1	BEB1Z	62"	33"	7.5 lbs	188.95
Benbo 2	BEB2Z	101"	45"	8.27 lbs	199.95
Benbo Trekker Mk 2	BET	61"	33"	4.5 lbs	124.95
Benbo Mini Trekker	BEMT	28"	21.5"	3.4 lbs	79.95

**Benbo 1 Kit (BEBSK):** Includes Professional Ballhead and carry bag .....314.95

**Benbo 2 Kit (BEBSKQ):** Includes Professional Ballhead and carry bag .....356.95

**Benbo Trekker Kit (BETK):** Includes Professional Ballhead and carry bag ....189.95

## MAGIC SERIES

### Magic II Tripod

Known as the most compact, full height tripod available today, the Magic II is the tripod which photographers and enthusiasts alike can take with them wherever they go, due to its compact size. When folded flat, the magic measures a mere 13¾" high and 1.5" thick, and can fit into the bottom pocket of many camera bags. Assembled



in no time at all, it provides remarkable stability, even when fully extended. The Magic II can also be converted into a full height monopod. Simply unscrew one of the legs and join it up to the removable center column. The unique one-twist mechanism allows the tripod legs to lock at one quick turn of the topmost leg portion. The entire tripod is anodized in a cobalt

matte finish for reflection free photos. The Magic II comes equipped with a removable ballhead, Quick Release and plate, and weighs only 2.5 lbs.



#### Mini Magic



A smaller sized Magic tripod with the same unique "fold flat" design as Magic II. It includes a sliding, reversible center column with a ballhead. A small 8½" length when closed, the Mini Magic extends to over 21", yet weighs just 1.5 lbs. It's folded dimensions are 8.5 x 6 x 1.5".

Mini Magic (CUMM).....72.95

#### Chestpod Magic

The special tripod for steady camera control after a long day. To prevent the arms getting tired, the weight of the camera is transferred to the body. When not actually shooting both your hands are free. Features a sliding column, quick coupling system and a quick release ball head.

Chestpod Magic (CUCM).....69.95

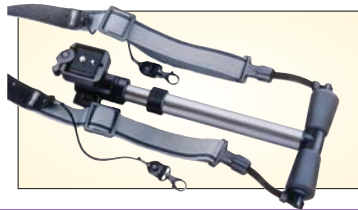

#### Clamp Magic



For situations in which, for some reason or other, a tripod can not be used. The clamp provides perfect camera support on round, angular

or irregularly shaped objects. Clamp Magic features a sliding column and includes a ball head with a 1/4-20" standard screw. It has a load capacity of 5.5 lbs.

Clamp Magic (CUCMQ).....76.95

### MAGIC SERIES SPECIFICATIONS

	Magic 2	Mini Magic	Chestpod Magic
Load Capacity	7.7 lbs.	6.6 lbs.	6.6 lbs.
Minimum Usable Height	13"	13"	13"
Maximum Extension	57"	21"	15.5"
Leg Sections	4	1	2
Center Column Sections	2	1	1
Weight	2.5 lbs.	1.5 lbs.	1 lb.

Since 1955, Cullmann has been manufacturing professional tripods and accessories. The tripods can be extended with the many variable system accessories. Cullmann tripods are noted for their outstanding stability and ease of handling. The "quick release" system that allows you to put on and take off your photo equipment from your tripod was invented by Mr. Cullmann, and is now a universal system of camera mounting. Many other innovations, such as built-in carrying handles, hexagonal shaped legs, top lock adjustment levers, and center columns all add up to the most extensive line of advanced amateur and professional tripods and accessories available today.

## TRIPODS

### Mini and Specialty Tripods

*Cullmann Specialty Tripods have been designed to provide photographers with the answers to a variety of camera-mounting problems, especially where size, space, and surface texture might be a consideration.*



**CU-50001 Piccolo (CUP)**  
Smaller than a pack of cigarettes, the Piccolo has a 3-way adjustable head and 5 section legs.....**18.95**



**CU-3090 TravelPod (CUTP)**  
Combined shoulder/table top tripod with unique folding shoulder stabilizer. 2 way video head with quick release coupling. Great for cameras, camcorders, and binocular.....**54.95**



**CU-3080 MultiPod (CUMP)**  
Multi-faceted mounting system, great for still or video filming in auto, ship, train, or even small plane. Sure-grip rubber feet and suction cup mounting for smooth surfaces.....**59.95**



*Touring Kit (CUTS).....***139.95**

## TOURING SET

*The perfect outdoor tripod, the Touring Set provides any amount of combinations for getting the shot where most other tripods don't even come close. This 5 piece kit is perfect for all still and video applications, when shooting on any ground, from any angle, from any position. Extremely quick to set up, each accessory included in the set can be used either by itself, or in conjunction with any of the other accessories. The Touring Set is a "must have" for any nature or outdoor photographer.*

#### Mini-Tripod (CUC)

The heart of the set, this sturdy 3 section tripod has a removable center column which can be reversed for shooting close-ups. A removable ball head is mounted on top of the tripod.....**54.95**

#### Woodscrew (CUWS)

Can be screwed into beams, fence posts, park benches, and tree stumps (never screw into live trees) .....**16.95**

#### Universal Clamp (CUCU)

The Universal Clamp ensures secure mounting to round, square, or irregularly shaped objects, such as tree limbs or fence post.....**39.95**

#### Ground Spike (CUGS)

For pushing into any ground like sand, earth, snow, pebbles, etc. Can also be used with the ball head, for positioning of your camera or camcorder.....**16.95**

#### Suction Mount (CUSM)

Gives a safe and sure grip on any smooth surface such as glass, marble, metal, or plastic, or car windows. The ball head handles a load of 6 lbs.....**34.95**





# MINI TRIPODS

## U.Pod

Constructed of an aluminum alloy, protected by a wear-proof black laquer, they are available with built-in pan or ball head. The legs fold into the central column for storage or use as a mini-monopod (pistol grip). Unfolded the legs become a platform turning the U.Pod into a stable mini tripod supporting up to 7 lbs. The QU100 and QU 200 fold to 9.65" and extend to 14.4". The QU 400 folds to 11.6" and extends to 18.5". A wrist strap is built-in for added convenience.



- QU100 with Pan Head (GICTTPH).....34.95**
- QU200 with Ball Head (GICTTBH .....32.95**
- QU 400 with Ball Head and Quick Release (GICTTBH.....45.95**

## Q.Pod & Ball.Pod

Unbelievably small yet extraordinarily strong pocket tripods for cameras, telescopes, binoculars and camcorders. Although they are the smallest tripods in the world, the Q.Pods (tilt head) and Ball.Pods (ball head) are multi-functional, strong and the best choice when traveling. Titanium finish with rubber tipped legs they stand steady on any surface and are suitable for any occasion. Available in a two or five-section leg design, each has a minimum height of 3", extended height of 4.25", weighs 3.7 oz. and includes a case.



### Compact Q.Pod (GICQPT)

- 2-section rubber tipped legs
- Tilt head with 1/4-20 thread and video pin
- Folds flat (folded size 5 x 1.5 x 0.9") .....**16.95**

### Compact Ball.Pod (GICBPT)

- 2-section rubber tipped legs
- Ball head with 1/4-20 thread and video pin
- Folds flat (folded size 5 x 1.5 x 0.9") .....**14.95**

### Mini Q.Pod (GIMQPT)

- 5-section rubber tipped legs
- Tilt head with 1/4-20 thread and video pin
- Folds flat (folded size 3.5 x 1.5 x 0.9") ...**21.95**

### Mini Ball.Pod (GIMBPT)

- 5-section rubber tipped legs
- Ball head with 1/4-20 thread and video pin
- Folds flat (folded size 3.5 x 1.5 x 0.9") ...**18.95**

## P.Pod



Made of solid aluminum alloy, the monopod feels solid and sturdy. Its surfaces are carefully polished twice to give its leg sections smooth and firm locking and quick unlocking action. Finally, it is anodized, preserving the distinctive look of aluminum and pure black finish. Now take it into the field.

Its three accessory feet can be deployed at the foot of the monopod, turning it into a tripod. Plus, its height is adjustable from 23.6" to 72.6".

Alternatively, the accessory feet can be fixed to its collar to turn the monopod into a low height tripod. Finally, fixing two of the feet around the neck of the monopod gives you a low angle tripod ideal for macro and nature photography.

Integral quick release pan head allows the camera to be instantly attached and detached. The 2-way tilt head allows 180° of movement.

- P.Pod (GIPP).....84.95**



## VT-800 Series

The VT-800 Series delivers exceptionally smooth geared center column movement with a crank and easy-locking knob. The 3-way pan head lets you mount and remove the camera by simply pushing the quick release lever. They also offer a bubble level, easy-to-lock and release leg locks, built-in handle, and a hook that lets you hang weight for greater stability.

**VT-806 (GIVT806):** With an air cushioned geared column, the VT-806 has a 60" maximum height, a 24" closed length, and weighs 2.4 lbs.....**38.95**

**VT-808 (GIVT808):** Maximum height 60", closed length 24", it weighs 2.9 lbs.....**42.95**

**VT-809 (GIVT809):** Maximum height 65", closed length 27", it weighs 3.9 lbs.....**62.95**

## MONOPODS

Monopods are specially designed for photographers on the move, shooting fashion or sports. Monopods support heavy cameras, let you make instant changes to angle, and position in restricted spaces to capture the perfect shot. Available in 3-, 4- 5- and 6-section models, in aluminum or carbon fiber, all Giotto's monopods feature foam-padded grip, rubber-covered leg locks, 3/8" and 1/4" camera screw, and a rubber ball foot that accepts accessory spikes or shoes. The rubber foot gives them firm ground support and flexibility of up to 360° of tilt. Carbon fiber models also feature a spring-loaded foot pedal for added support, and all monopods are equipped with an adjustable wrist strap, case and toolkit.



	Aluminum Monopods			Carbon Fiber Monopods		
<b>Model</b>	<b>MM-9160</b>	<b>MM-9170</b>	<b>MM-9180</b>	<b>MM-8950</b>	<b>MM-8970</b>	<b>MM-8990</b>
<b>Load Capacity</b>	33 lbs.	33 lbs.	33 lbs.	33 lbs.	33 lbs.	33 lbs.
<b>Extended Length</b>	62"	66.5"	70.5"	59"	70"	75"
<b>Leg Sections</b>	5	4	5	3	3	4
<b>Weight</b>	1.3 lbs.	1.7 lbs.	1.6 lbs.	1.3 lbs.	1.3 lbs.	1.3 lbs.
<b>Item Code</b>	<b>GIMP5</b>	<b>GIMP466</b>	<b>GIMP570</b>	<b>GIMPCF359</b>	<b>GIMPCF370</b>	<b>GIMPCF4</b>
<b>Price</b>	<b>54.95</b>	<b>56.95</b>	<b>62.95</b>	<b>114.95</b>	<b>139.00</b>	<b>139.00</b>

## BALL HEADS

### MH-1004 (GIMH1004)

The smallest ball head with single knob for the ball and the pan. Weighs 4.8 oz., 2.4" height, capacity 5 lbs. Top plate with 1/4" camera thread. Base with 3/8" tripod socket with 1/4" reducing bushing.....9.95



### MH-1003 (GIMH1003)

Small ball head with single knob for the ball and the pan. Weighs 5.3 oz., 2.8" height, 8.8 lb capacity. Top plate with 1/4" camera thread. Base with 3/8" tripod socket with 1/4" reducing bushing.....39.00



### MH-1002 (GIMH1002)

Compact ball head with ball lock knobs and pan lock. Weighs 8.4 oz., 3" height, 13 lb capacity. Top plate with 1/4" camera thread. Base with 3/8" tripod socket & 1/4" reducing bushing. Includes draw string pouch .....59.00

### MH-1001 (GIMH1001)

Medium ball head with calibrated tension and lock knobs and pan lock. Weighs 13 oz., 4" height, 17.6 lb. capacity. Top plate with 1/4 and 3/8" camera threads. Base with 3/8" tripod socket with 1/4" reducing bushing. Includes draw string pouch .....89.00

### MH-7001 (GIM7001)

Ball head with built-in quick release supports 13 lbs. Camera plate slide to aid in macro camera positioning. QR has two bubble levels and is equipped with 1/4 and 3/8" camera screws. Weighs 21 oz. and is 4.3" high. Base with 3/8" tripod socket with 1/4" reducing bushing. Includes draw string pouch....54.95

### MH-1000 (GIMH1000)

Large ball head with calibrated tension and lock knobs and pan lock. Weight 20.6 oz., 4.5" height, 22 lb. capacity. Top plate with 1/4 and 3/8" camera threads. Base with 3/8" tripod socket with 1/4" reducing bushing. Includes draw string pouch .....109.00

### MH-2000 (GIMH2000)

Large ball head with dual ball design. Calibrated tension and lock knobs. Weighs 23.5 oz., 5.4" height, 26.5 lb. capacity. Top with 1/4 and 3/8" camera threads. Base with 3/8" tripod socket with 1/4" reducing bushing. Includes draw string pouch .....149.95

### MH-3000 (GIMH3000)

The largest Giottos ball head. Calibrated tension pan and lock knobs. Weighs 42 oz., 5.4" height, 33 lb. capacity. Top with 1/4 & 3/8" camera threads. Base with 3/8" tripod socket with 1/4" reducing bushing. Includes draw string pouch.....119.95



### 3-Way Pan Heads

3-way pan head with lever lock, 1/4" thread, bubble level, padded handles, 3/8" tripod socket with reducing bushing. Weighs 1.3 lbs., supports 18 lbs. Includes pouch case. (GIPH) .....54.95

3-way pan head with double locking quick release and 1/4" thread, two bubble levels, padded handles, 3/8" tripod socket with bushing. Weighs 1.5 lbs., supports 18 lbs. Includes pouch case. (GIPHQR) .....60.95

### Quick Release Adapters with Plate

For MH-1000, MH-1001, MH-2000, MH-3000, and M-7001 Ball Heads.

MH 100 (GIMH100): With 1/4" thread. Camera plate release via lever .....24.95

MH 200 (GIMH200): With 1/4" and 3/8" thread. Camera plate release via screw .....34.95

MH 500 (GIMH500): With 1/4" and 3/8" thread. Camera plate release via screw .....42.95

MH 621 (GIM621): With 1/4" and 3/8" thread. Plate slides for macro positioning .....28.95

MH 652 (GIMH652): With 1/4" and 3/8" thread. Fits most ballheads.....24.95



## TRAVELER SERIES

### *Sport Carbon Performance Tripods*

With such a good ratio of compact folded length to extended open height, the Traveler is the ideal tripod to carry with you around the world. Gitzo's unique patented 180° folding mechanism accommodates the head inside the folded tripod legs and makes this the smallest folded tripod for its open size and number of sections. Matching this compactness with the sturdiness of lightweight carbon fiber and good speed in setup makes the Travelers the ultimate tripods.

Two models are available, 5-section GT1550T with removable ball head (G1077M) and 4-section GT1540T (without head). Traveler tripods feature an upper disc in a safe lock material that cuts vibrations and improves the grip between tripod and head. The upper disc can also be fixed directly to the tripod top casting, thus eliminating the center column. This is called "Ground Level Set" and allows for low shooting positions and further weight savings. Tripods come with a convenient anti-dust bag for storage and packing.

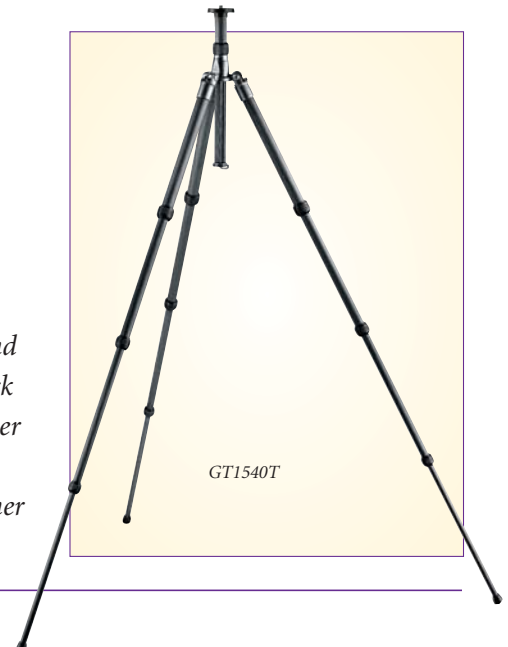

#### FEATURES

- ◆ Made of Carbon 2, a six-layer tube construction process that makes it stronger than existing carbon, yet 15% lighter. Also provides greater capacity to absorb vibrations and withstand fatigue.
- ◆ The Traveler is the most compact carbon fiber tripod in the world. When opened, it is as tall as a standard Gitzo tripod, but thanks to its 180° folding mechanism, it is 25% shorter than standard when folded.
- ◆ With the Anti-Leg-Rotation (ALR) system, you just loosen all twist locks at the same time and pull down the leg before tightening the twist locks. setups up in just 15 seconds.
- ◆ The center column locking collar above the tripod shoulder makes it easier to adjust the column quickly. The Traveler also is built with Gitzo's anti-rotation grooved center column for improved stability.
- ◆ The rapid column can easily be inverted for low level shooting and macro work.
- ◆ Built-in accessory hook allows you to hang a stabilizing weight (e.g. a full camera bag or a sand/water bag) from the bottom of the tripod center column. Useful with long heavy lenses, uneven ground or in windy conditions. The hook can hold up to 40 lb.

#### Ground Level Set

For low angle shooting, the center column can be removed and the upper disc fitted directly to the tripod top casting. The disc is locked into position using the retractable column hook. The ground level configuration can be achieved in a few seconds without tools or extra components, and only the column need be removed. With this effective and simple built-in solution, Gitzo has dramatically increased the ways you can use the tripod.

Lightweight and compact 4- and 5-section tripods designed to fit into your hand luggage. An excellent choice for compact digital cameras and digital SLRs, or even for lightweight camcorders. When used with an SLR or DSLR, the Traveler is ideal for a range of lenses up to 200mm. Offers an excellent maximum load capacity with good torsional rigidity at a very low weight.

The GT1550T (only) includes removable G1077M Magnesium center ball head, so no additional expense for a head is necessary. When closed, the head is protected under folded legs.



	Column Type	Leg Sections	Max. Height with Extended Center Column	Max. Height Column Down	Minimum Height	Closed Height	Weight	Max. Load Capacity	Price
GT1540T (GIGT1540T)	Rapid	4	55.1"	46.9"	14.2"	14.2"	2.2 lbs	4.4 lbs	559.95
GT1550T (GIGT1550T)	Rapid	5	57.5"	49.6"	14.2"	16.1"	2.2 lbs	9.9 lbs	639.95

## LEVELING TRIPODS

*Gitzo's revolutionary Leveling tripods are designed for photographers who need fast set up and leveling accuracy. Inside the tripod's upper casting is a special free-rotating ball, similar to those normally used in Gitzo's ball heads. The center column passes through this ball and can both be moved up and down, and be inclined in any direction at any angle up to 15°. The inclination and vertical movements are completely independent. This patented system is extremely useful for panoramic, outdoor and wildlife photographers or for birdwatching because the Leveling system allows the camera or scope to be set perfectly horizontal easily and quickly when working on uneven ground.*

*Leveling tripods are available in two heights: eye level and standard, and in two materials: Carbon 6X and Basalt. They benefit from many new Gitzo features that improve performance, versatility and quality. G-Lock leg locking system increases system rigidity by 20% and allows quicker and stronger leg locking. Lightweight high quality technopolymer upper disc to the Basalt model, while the Carbon 6X tripods feature a solid machined aluminium upper disc with a new Safe Lock material that cuts vibration and improves grip between tripod and head. All Leveling tripods also feature new ground level set: the center column is removable and the upper disc can be fitted directly to the upper casting. With only a few seconds of set up, this clever built-in solution dramatically increases the tripods' flexibility allowing for ultra low shooting angles, weight reduction and increased stability. All come with a convenient anti dust bag for storage and packing.*



## FEATURES

## How to Level the Tripod



Open the tripod, leaving the center column down. Loosen the leveling system locking knob.

Adjust the center column inclination to get it level - for reference use the built-in spirit level.

When the column is

correctly leveled, tighten the locking knob, slide the center column to the required height.

◆ Ideal support for fluid heads, the Leveling tripod sets the camera perfectly horizontal while the fluid head allows pan and tilt movements. Recommended for lenses up to 300mm.

- ◆ Made of machined aluminum, the upper disc features Gitzo's new Safe Lock material. The disc can be mounted directly to the tripod top casting (Ground Level Set feature). The 1/4-3/8" reversible screw has been redesigned for more reliable functionality.
- ◆ Gitzo's G-Lock leg locking system has been completely redesigned, and achieves a 20% increase in rigidity, faster operation and stronger, safer locking. G-Lock's special design also provides a "gravity lock" effect: the higher the load applied vertically to the leg, the stronger the lock.
- ◆ Only takes seconds to open and secure the tripod with the Anti-Leg-Rotation system. Just loosen all twist locks at the same time and pull down the leg before tightening the twist locks, making setup just 15 seconds.
- ◆ Includes removable rubber feet, allowing you to easily change worn out rubber feet or to fit other accessories, such as spiked feet or snow/sand shoes.
- ◆ Rapid column can be inverted for an alternative shooting angle or low level macro work.
- ◆ Center column locking collar above the tripod shoulder makes it easy to quickly adjust the column. Built with anti-rotation grooved center column for improved stability.
- ◆ Built-in accessory hook lets you hang a stabilizing weight (camera bag or a sand/water bag) from the bottom of the tripod center column. Ideal for use with long heavy lenses, on uneven ground or in windy conditions. The hook can hold up to 40 lbs.
- ◆ Includes anti-dust bag for storage

	Column Type	Leg Sections	Max. Height with Extended Center Column	Max. Height Column Down	Minimum Height	Closed Height	Weight	Max. Load Capacity	Price
GT2530LVL (GIGT2530LVL)	Rapid	3	62.6"	54.3"	14.2"	25.6"	3.5 lbs	26.5 lbs	659.95
GT2540LVL (GIGT2540LVL)	Rapid	4	67.7"	59.4"	12.6"	24"	3.7 lbs	26.5 lbs	744.95
GT2941LVL (GIGT2941LVL)	Rapid	4	71.7"	59.8"	12.6"	24"	4.2 lbs	22 lbs	574.95



## MOUNTAINEER SERIES

### Carbon Fiber Tripods

When Gitzo launched the Mountaineer tripods in 1994, they were the world's first carbon fiber tripods. Ever since then they've set the standard for performance and quality. The main feature of the range is the new 6x carbon fiber tube, made of a unique structure of 6 crossed layers that maximizes rigidity, vibration absorption and lightweight performance. 6x tube has a high density structure made of top quality ultra-thin carbon fibers (7µm or 0.007 mm). Built-in Anti Leg Rotation is now a feature of the whole carbon fiber range. Mountaineer tripods have been further improved with features and details that increase performance, versatility and quality. G-Lock leg locking system increases system rigidity by 20% and allows quicker and stronger leg locking. Solid machined aluminium upper disc with a new Safe Lock material cuts vibration and improves grip between tripod and head. The upper disc can also be fitted directly to the upper casting, removing the center column for ground level photography or to save weight. All Mountaineer tripods come with a convenient anti dust bag for storage and packing.

- ◆ Mountaineer tripods set a new standard. Every single component has been reviewed to reach a new level of quality and performance.
- ◆ Anti Leg Rotation system means the tripod can be opened in less than 15 seconds. Simply loosen all the twist locks on each leg at the same time, then pull the leg down and tighten the locks individually.
- ◆ The rapid column can easily be inverted for low level shooting and macro work.
- ◆ G-Lock locking system has been redesigned in order to achieve a 20% increase in rigidity, faster operation and stronger, safer locking. G-Lock's special design also provides a "gravity lock" effect: the higher the load applied vertically to the leg, the stronger the lock.
- ◆ Center column locking collar above the tripod shoulder makes it easy to adjust the column quickly. Built with anti-rotation grooved center column for improved stability.
- ◆ Built-in accessory hook lets you hang a stabilizing weight (camera or a sand/water bag) from the bottom of the tripod center column. Ideal for use with long heavy lenses, on uneven ground or in windy conditions. The hook can hold up to 40 lbs.
- ◆ Includes removable rubber feet, allowing you to easily change worn out rubber feet or to fit other accessories, such as spiked feet or snow/sand shoes.

### Carbon 6x

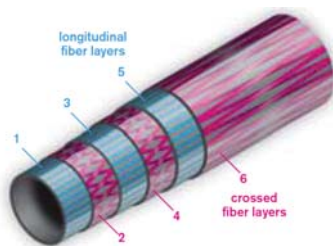

Carbon 6x is a high density tube made of top quality ultra thin (7µm) carbon fibers (a 28 mm tube contains 1.500.000 carbon fibers) in a unique structure of 6 crossed layers that minimizes weight yet

maximizes rigidity, vibration absorption and performance. In order to optimize the weight to strength ratio, Gitzo varied the wall thickness of 6x tube according to tripod series: tubes for Series 00, 0 and 1 are 1mm thick, tubes for Series 2 are 1.2mm thick, Series 3 tubes measure 1.3mm, Series 4 1.4mm and Series 5 is 1.5mm. All 6x tubes feature built-in Anti Leg Rotation system.

### Series 00 (Table Series)

The smallest and lightest tripod in the Gitzo range, Series 00 offers surprisingly good rigidity. Ideal for spotting scopes, binoculars, compact and DSLR cameras with lenses up to 175mm. Convenient for use on top of tables or when working at ground level.

### Series 0 (Weekend Series)

Recommended for compact cameras, lightweight camcorders and DSLRs with a range of lenses from wide angle to 135mm. Given its small size and extremely light weight, this tripod offers an interesting compact solution for the latest generation of digital equipment. The G-lock system and improved tube structure give good performance in terms of torsional rigidity.



	Column Type	Leg Sections	Max. Height with Extended Center Column	Max. Height Column Down	Minimum Height	Closed Height	Weight	Max. Load Capacity	Price
GT-530 (GIGT530)	Rapid	3	26.4"	22"	11"	12.2"	0.8 lbs	6.6 lbs	334.95
GT0530 (GIGT0530)	Rapid	3	51.5"	42.1"	10.6"	20.9"	1.6 lbs	11 lbs	364.95
GT0540 (GIGT0540)	Rapid	4	55.9"	46.5"	18.9"	24"	1.7 lbs	11 lbs	434.95

## MOUNTAINEER SERIES

### Series 1 Mountaineer Sport Tripods

An excellent choice for compact digital cameras and DSLRs with a range of lenses up to a maximum of 200mm, the GT-1530, GT-1540 and GT-1540G Mountaineer Sport tripods set the standard for lightweight tripods, offering a high maximum load together with a very low weight. Traveling with a tripod has never been so easy. They offer excellent maximum load capacity and good torsional rigidity at a reduced weight.

### Series 2 Mountaineer Reporter Tripods

Recommended for lightweight camcorders, spotting scopes and DSLRs with a range of lenses up to 300mm maximum. Excellent maximum load capacity and good torsional rigidity, available in 3- and 4-section models at standard and eye level heights. Series 2 is the ideal solution for photographers that are looking for a solid tripod without sacrificing weight. They have a maximum load capacity of 27 lbs., and are available in a geared version that combines the strength and stability of the Mountaineer range with the precision height adjustment of an aluminum geared column.

### Series 3 Mountaineer Studex Tripods

For photographers who will settle for nothing less than a Studex Carbon Fiber Tripod, but require the extra stability for heavy loads. Scaled for professional equipment, medium format and DSLRs with a range of lenses up to 400mm maximum. High maximum load capacity and outstanding torsional rigidity, Available in 3- and 4-section models at standard and eye level heights. Series 3 Carbon 6x tripods are surprisingly lightweight which makes them an excellent choice for photographers that travel.

### Ground Level Set— available on all Mountaineer Tripods

For low angle shooting, the center column can be removed and the upper disc fitted directly to the tripod top casting. The disc is locked into position using the retractable column hook. The ground level configuration can be achieved in a few seconds without tools or extra components, and only the column need be removed. With this effective and simple built-in solution, Gitzo has dramatically increased the ways you can use the tripod.



	Column type	Leg sections	Max. height with extended center column	Max. height column down	Min. height	Closed height	Weight	Max. Load Capacity	Price
<b>GT1540G</b> (GIGT1540G)	Geared	4	58.7"	52.4"	11.4"	20.5"	2.8 lbs	17.6 lbs	<b>594.95</b>
<b>GT1530</b> (GIGT1530)	Rapid	3	61"	52.8"	13.4"	24.4"	2.5 lbs	17.6 lbs	<b>479.95</b>
<b>GT1540</b> (GIGT1540)	Rapid	4	62.6"	54.3"	11.4"	21.3"	2.5 lbs	17.6 lbs	<b>534.95</b>
<b>GT2540G</b> (GIGT2540G)	Geared	4	62.6"	50.8"	11.8"	21.3"	4 lbs	26.5 lbs	<b>639.95</b>
<b>GT2540</b> (GIGT2540)	Rapid	3	61.4"	52.4"	11.4"	22"	3.1 lbs	26.5 lbs	<b>574.95</b>
<b>GT2530</b> (GIGT2530)	Rapid	3	63.4"	54.3"	13"	25.6"	3.2 lbs	26.5 lbs	<b>519.95</b>
<b>GT2541L</b> (GIGT2541L)	Rapid	4	68.9"	59.4"	12.6"	24"	3.3 lbs	26.5 lbs	<b>649.95</b>
<b>GT3540</b> (GIGT3540)	Rapid	4	63.4"	63.4"	14.2"	21.7"	4.4 lbs	39.7 lbs	<b>699.95</b>
<b>GT3530</b> (GIGT3530)	Rapid	3	64.4"	64.6"	17.3"	26"	4.7 lbs	39.7 lbs	<b>629.95</b>
<b>GT3540L</b> (GIGT3540L)	Rapid	3	71.3"	71.3"	15.4"	23.6"	4.7 lbs	39.7 lbs	<b>774.95</b>



## BASALT SERIES

### “Rock Solid” Tripods Made from Space-Age Materials

Gitzo the first and only manufacturer of a new generation of tripods that use Basalt fiber tubes. The fiber is made from basalt rock which is crushed and melted (at 1500°C or 2735°F). The extracted fibers are transformed into a tube via the same technology used for Gitzo Carbon 6X tube. Basalt tube has most of the features of carbon fiber, like high thermal and dimensional stability and reduced weight (20% lighter than aluminum). Like 6X, it is engineered to match Gitzo's performance standards. Basalt tubes have a 1.2mm thick wall, a 3 crossed layer structure with built in Anti Leg Rotation (ALR). The performance and price of Basalt tripods puts them between aluminum and high performance Carbon 6X. Features inherited from the Mountaineer tripods include G-Lock leg locking system that increases system rigidity by 20% and allows quicker and stronger leg locking - and the new “Ground Level Set” feature that allows the upper disc to be fitted directly to the top casting, removing the center column for ground level photography or to save weight. Basalt tripods come with a convenient anti dust bag for storage and packing.



#### FEATURES

- ◆ Basalt tube is 20% lighter than aluminum and offers intermediate performance between aluminum and Carbon 6x tubing.
- ◆ Every single component of the Basalt tripod range has been fine-tuned to reach new levels of quality and performance.
- ◆ G-Lock system has been redesigned in order to achieve a 20% increase in rigidity, faster operation and stronger, safer locking. G-Lock's special design also provides a “gravity lock” effect: the higher the load applied vertically to the leg, the stronger the lock.
- ◆ Anti Leg Rotation system means the tripod can be opened in less than 15 seconds. Simply loosen all the twist locks on each leg at the same time, then pull the leg down and tighten the locks individually.
- ◆ The rapid column can easily be inverted for low level shooting and macro work.
- ◆ The center column locking collar above the tripod shoulder makes it easier to adjust the column quickly. Built with an anti-rotation grooved center column for improved stability.
- ◆ Built-in accessory hook lets you hang a stabilizing weight (camera or a sand/water bag) from the bottom of the tripod center column. Ideal for use with long heavy lenses, on uneven ground or in windy conditions. The hook can hold up to 40 lbs.
- ◆ Includes removable rubber feet, allowing you to easily change worn out rubber feet or to fit other accessories, such as spiked feet or snow/sand shoes.
- ◆ The upper disc is a completely new design, made of a special techno polymer that maximizes locking performance. For low angle work, it can be mounted directly to the top casting (Ground Level Set feature). The 1/4 - 3/8” reversible screw has been redesigned for more reliable functionality.
- ◆ For low angle shooting, the center column can be removed and the upper disc fitted directly to the tripod top casting. The disc is locked into position using the retractable column hook. The ground level configuration can be achieved in a few seconds without tools or extra components, and only the column need be removed. With this effective but simple built-in solution, it dramatically increases the ways you can use the tripod.

	Column type	Leg sections	Max. height with extended center column	Max. height column down	Min. height	Closed height	Weight	Max. Load Capacity	Price
GT-921 (GIGT921)	Rapid	2	33.5"	24"	15.4"	17.3"	1 lbs	6.6 lbs	265.95
GT0931 (GIGT0931)	Rapid	3	52.4"	42.9"	10.6"	21.7"	1.9 lbs	8.8 lbs	299.95
GT1931 (GIGT1931)	Rapid	3	66.1"	53.5"	13.4"	25.6"	3.1 lbs	15.4 lbs	534.95
GT2931 (GIGT2931)	Rapid	3	64.6"	52"	12.6"	25.2"	3.6 lbs	22 lbs	359.95
GT2941 (GIGT2941)	Rapid	4	66.1"	53.5"	11.4"	22"	3.7 lbs	22 lbs	404.95
GT2941L (GIGT2941L)	Rapid	4	72.4"	59.4"	12.2"	23.6"	3.9 lbs	22 lbs	574.95

## EXPLORER

The Explorer is a tripod designed for special applications; a versatile support to explore new shooting perspectives. Thanks to its unconventional design, the legs can be set at any angle and moved independently while the center column tilts and rotates freely to any position. The Explorer unleashes its potential when used with a Gitzo off-center ball head, a combination that makes it the ideal tripod for creative photographers looking for unconventional shots: close to ground, upside-down or in tight or awkward spaces. Ideal applications are outdoor macro and nature photography, still life and architectural. Explorer tripods in both Carbon 6x and Basalt feature G-Lock, leg locking system that increases system rigidity by 20% and allows quicker and stronger leg locking. Carbon 6x Explorers feature a solid machined aluminum upper disc with a new Safe Lock material that cuts vibration and improves grip between tripod and head. Explorer tripods (except G220) also come with a convenient anti dust bag for storage and packing.

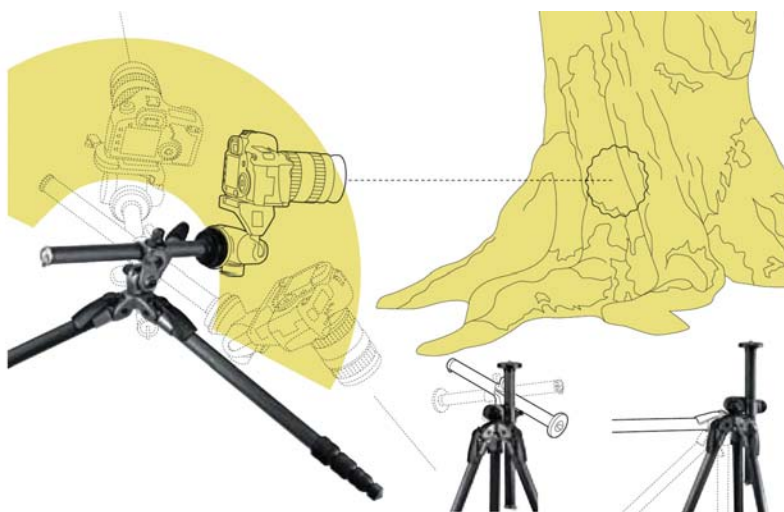

## FEATURES

- ◆ The key technical solutions devised for the Explorer are its free leg angle locking and its offset center column with free inclination and rotation lock. Combined with features such as the stabilizing hook and invertible column, they'll help you discover new ways of using a tripod.
- ◆ Fitted with a column that can tilt from vertical to beyond horizontal, rotate 360° and lock safely at any intermediate angle.
- ◆ Anti Leg Rotation system means the tripod can be opened in less than 15 seconds. Simply loosen all the twist locks on each leg at the same time, then pull the leg down and tighten the locks individually.
- ◆ The center column locking collar above the tripod shoulder makes it easier to adjust the column quickly. Built with an anti-rotation grooved center column for improved stability.
- ◆ G-Lock system has been redesigned in order to achieve a 20% increase in rigidity, faster operation and stronger, safer locking. G-Lock's special design also provides a "gravity lock" effect: the higher the load applied vertically to the leg, the stronger the lock.
- ◆ Includes removable rubber feet, allowing you to easily change worn out rubber feet or to fit other accessories, such as spiked feet or snow/sand shoes.
- ◆ The Explorer's legs can be positioned independently at any angle from 0° to 90°.
- ◆ The best choice for DSLR or for lightweight camcorders. Recommended for lenses up to 300mm maximum. Series 2 offers an excellent maximum load capacity and very good torsional rigidity. Weight and size are convenient for travelling or trekking.
- ◆ Built-in accessory hook lets you hang a stabilizing weight (camera or a sand/water bag) from the bottom of the tripod center column. Ideal for use with long heavy lenses, on uneven ground or in windy conditions. The hook can hold up to 40 lbs.

	Column type	Leg sections	Max. height with extended center column	Max. height column down	Min. height	Closed height	Weight	Max. Load Capacity	Price
GT2530EX (GIGT2530EX)	Rapid	3	66.9"	55.5"	0"	26.8"	4.1 lbs	26.5 lbs	539.95
GT2540EX (GIGT2540EX)	Rapid	4	64.6"	43.1"	0"	22.4"	4.1 lbs	26.5 lbs	579.95
GT2931EX (GIGT2931EX)	Rapid	3	59.8"	58.8"	0"	25.2"	4.4 lbs	22 lbs	439.95
G2220 (GIG2220)	Rapid	3	63.8"	49.6"	0"	25.2"	5.2 lbs	19.8 lbs	249.95



## MONOPODS



Monopods are traditionally used at sport events and in situations where space is tight and framing speed is a key factor. The ideal monopod needs to be lightweight, extremely fast to open and close, fast and precise in height adjustments for sudden changes in shooting position. Thanks to ALR and G-Lock, Gitzo monopods continue to set the standard for professionals and advanced amateurs. The range has been completely revised to offer lighter, faster and more stable products.

Available on Carbon fiber, Basalt and Aluminum (GM2340 only) models, Anti Leg Rotation makes them incredibly fast to operate and the height can be easily and precisely adjusted. Carbon 6x crossed layer tubing makes carbon fiber models surprisingly light and even more convenient for transportation. Carbon fiber and Basalt monopods also feature the G-Lock system for faster and stronger locking and increased rigidity. All 'GM' monopods come with a convenient anti dust bag for storage and packing.

### GM2560T Traveler Monopod (GIGM2560T)

The GM2560T Traveler combines advanced Gitzo technology into exceptionally compact dimensions. It features ultra light Carbon 6x tubes, Anti Leg Rotation, 6-section construction and Safe Lock upper disc. It can be fully extended in seconds, allowing unsurpassed flexibility of use. Stores in any computer bag and it is recommended for "frequent flyer" photographers. ....209.95

### GITZO MONOPODS

	Construction	Minimum Height	Maximum Height	Weight	Maximum Load	Number of Sections	Price
GM2560T (GIGM2560T)	6x Carbon	14.2"	56.3"	1 lbs.	9.5 lbs.	6	209.95
GM2540 (GIGM2540)	6x Carbon	20.9"	63"	0.8 lbs.	26.5 lbs.	4	239.95
GM3550 (GIGM3550)	6x Carbon	21.3"	75.6"	1.4 lbs.	40 lbs.	5	274.95
GM5540 (GIGM5540)	6x Carbon	21.7"	63.8"	1.9 lbs.	55 lbs.	4	304.95
GM2941 (GIGM2941)	Basalt	20.5"	61.8"	1.2 lbs.	22 lbs.	4	179.95
GM2340 (GIGM2340)	Aluminum	19.3"	61.4"	1.3 lbs.	19.8 lbs.	4	154.95
G1566 (GIG1566)	Aluminum	16.1"	55.1"	1.6 lbs.	28.7 lbs.	6	145.00
G1564 (GIG1564)	Aluminum	23.2"	62.6"	2 lbs.	28.7 lbs.	4	126.95
G1564L (GIG1564L)	Aluminum	23.6"	79.5"	2.1 lbs.	28.7 lbs.	5	141.95
G1560 (GIG1560)	Aluminum	31.9"	64.6"	0.9 lbs.	4.4 lbs.	3	135.00



### LegCoat Tripod Leg Covers

LegCoat tripod leg covers help you protect your shoulders when carrying your gear and also break up the shape of your tripod at the same time. Made of heavy-duty closed cell neoprene and foam padding, they are soft to the touch but rugged in function. These covers come in a set of three, sized specifically for Gitzo or Manfrotto tripod models. The padding guards your hands from the cold tripod legs in lower temperatures, and can protect the tripod from minor nicks and scratches. Made with "hook & loop" fasteners for easy assembly. Covers are available in a standard (Forest Green) camouflage pattern, Max 4 HD, Black, and RealTree Hardwoods Snow (blends perfectly with snow-covered trees, bushes and rocks, which are seldom seen with a complete covering of snow). Call or go on-line to find the correct cover.

## TRIPOD HEADS

The Gitzo range is composed of different styles of heads that allow you to choose the best head for your needs. Each Gitzo head has been carefully designed to work with a specific tripod series. There are heads in various designs and sizes which allow the photographer to position any camera precisely for the required shooting position, with minimum effort to obtain optimum results. Gitzo introduced Magnesium heads to the photographic industry, which offer the advantage of being up to 20% lighter - and make perfect partners to Gitzo carbon fiber tripods. Gitzo heads cover all angles!



G1377M  
Center  
Ball  
Head

### Center Ball Heads

Exceptional fluid movement and total locking stability are the targets set for Gitzo's range of center ball heads. With their ergonomic design, they are easy and intuitive to use, while their advanced precision engineering guarantees high performance locking with a wide range of camera equipment. Independent pan and tilt controls lock the head exactly where it is set, without movement. All locking knobs have a rubber coating for a softer touch and an excellent grip.

The G1177M features a single lock for rapid and reliable locking in any position. The innovative Teflon coating applied to the ball surface of the larger heads (G1277M/G1377M and G1378M) makes camera positioning adjustments smoother than ever by eliminating all traces of jarring and skipping. The G1377M and G1378M incorporate a separate friction control which can be set to counterbalance the weight of the camera, giving total control over the finest adjustments.

	Series	Plate Type	Pan	Tilt	Pan Locking	Ball Locking	Friction Control	Height	Weight	Max Capacity	Price
G0077	00	Fixed with 1/4-20" screw	360°	+90°/-20°				2.3"	0.17 lbs	2.2 lbs	38.95
G1077M	0	Fixed with 1/4-20" screw	360°	+90°/-20°				2.3"	0.26 lbs	4.4 lbs	72.95
G1177M	1	Fixed with rev. 1/4-20" - 3/8" screw	360°	+90°/-20°				3.5"	0.68 lbs	8.8 lbs	101.95
G1178M	1	Quick Release with 1/4" screw	360°	+90°/-20°				3.8"	0.88 lbs	8.8 lbs	157.95
G1277M	2	Fixed with rev. 1/4-20" - 3/8" screw	360°	+90°/-30°	•	•		4.5"	1.1 lbs	13.2 lbs	162.00
G1278M	2	Quick Release with 1/4" screw	360°	+90°/-30°	•	•		4.7"	1.3 lbs	13.2 lbs	247.00
G1377M	3	Fixed with rev. 1/4-20" - 3/8" screw	360°	+90°/-40°	•	•	•	5.5"	1.9 lbs	17.6 lbs	210.95
G1378M	3	Quick Release with 1/4-20" screw	360°	+90°/-40°	•	•	•	5.7"	2.4 lbs	17.6 lbs	288.95

### Off-Center Ball Heads

Gitzo off-center ball heads offer a range of movement impossible with conventional heads, and are renowned for their smooth operation and positive locking mechanisms. The rotating center socket is the reason why they let you reach so many unusual angles. In fact, it's so extreme and so versatile that it allows a camera mounted on an inverted center column to be set right side up! A graduated base with independent lock allows perfect panoramic positioning. A teflon-based anodizing process gives it a refined, super-smooth movement.

These lightweight magnesium (20% lighter than the equivalent aluminum alloy head) off-center heads offer fixed or quick release camera plate versions. All non-quick release plate models have a single "I" slot for the camera mounting screw to allow fine positioning on the camera on the head. The design of these heads allows you to work in any axis which makes it the perfect head for the Explorer range of tripods.



G1275M Off-Center Ball Head

	Series	Plate Type	Pan	Side Tilt	Front/Back Tilt	Height	Weight	Max Capacity	Price
G1275M	2	Fixed with 1/4-20" screw	360°	+90°	360°	4.33"	1.21 lbs	11 lbs	157.95
G1276M	2	Quick release with 1/4-20" screw	360°	+90°	360°	4.72"	1.41 lbs	11 lbs	194.95
G1375M	3	Fixed with 1/4-20" screw	360°	+90°	360	5.12"	1.84 lbs	13.2 lbs	216.00
G1376M	3	Quick release with 1/4-20" screw	360°	+90°	360°	5.51"	2.07 lbs	13.2 lbs	251.00
G1576M	5	Quick release with 1/4-20" screw	360°	+90°	360°	5.91"	2.82 lbs	22 lbs	328.00



## DIGI TRIPODS

Manfrotto offers one of the widest range of tripods, heads and accessories for digital applications around the world. Their products are packed with well thought out features that make each piece of equipment easy to use and as versatile as possible. All tripods are carefully designed to optimize the critical balance between weight for portability, maximum and minimum height for low level as well as high level camera shooting, loading capacity and sturdiness. All models are engineered for reliability, vibration resistance, and long life. The wide choice of precision-built heads makes it easy to exactly match the need. Tripod heads are interchangeable for maximum versatility and economy. Heads and accessories are universal. You can be sure of outstanding images, whether in the studio or on location, with Manfrotto's well-proven equipment to support you.

### 709BR Digi Tabletop

Lightweight and compact, these 4-section table-top tripods are perfect for a wide range of digital photographic applications. Developed to maximize the superior imaging capabilities and versatility of today's compact digital cameras, the 709 series Digi-Table Tops sets up in seconds to form an exceptionally stable shooting platform that can be used virtually anywhere, indoors or out. It sports a handsome bright aluminum finish and comes complete with a silky-smooth Manfrotto Mini Ball Head providing 360° pan and ± 90° tilt. A convenient belt-loop carrying pouch is also available for it .....**28.95**

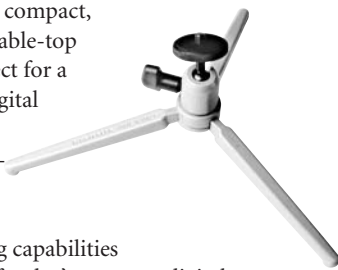

**709B Digi Table Top (BO709B):**  
Same as above in Black finish .....**28.95**

### 715B/715SHB Digi Tripod

The most compact, full size tripod in the Manfrotto range - the 715B and 715SHB DIGI are four section tripods with an integral ball head with micro "dovetail" quick release plate. The ball mechanism retracts into the main shoulder casting for an even shorter folded length in transport. The leg pivot uses a unique single hinge design in aluminum which both keeps the cross section smaller and allows the leg to fold shorter than conventional tripods. The built-in ball head allows you to adjust and set its friction so that it balances the weight of your camera without needing locking and unlocking between positions. All you have to do is point the camera and shoot. Adjustment is via a handle found on the bottom of the column; set it for your camera and forget it! If you prefer to lock the head for extra security, just turn the handle one more time. Despite the reduced size, there's been no compromise of stability.



Head movements: Pan 360° / Tilt ±90°

**715SHB Digi Tripod (BO715SHB):** .....**89.95**

**715B Digi Tripod:** Same as 715SHB, but with longer leg tubes for greater extended height (BO715B) .....**89.95**

### 718B/718SHB Digi-Tripods

The compact 718B and 718SHB have a built-in hybrid video/photo 3-way head. The 718B has longer leg sections for greater extended height (48.5"). The both have a "dovetail" quick release camera plate (which can be locked in place one-handed), separate pan and tilt locks, and a short pan/tilt bar for more ergonomic use while panning or tracking moving subjects. Like the 714SHB, the 718SHB is an extremely compact 4-section tripod with a short 15.9" folded length that will fit in your luggage with space left over.

On both 718B and 718SHB, the leg pivot system uses a unique single hinge design in aluminum which both keeps the cross section smaller and allows the leg to fold shorter than conventional tripods. The tripods are built with "D" profile tubular legs for extra torsional rigidity and quick flip leg locks for ease and speed of set-up. A quick action lever also blocks the reversible center column extension. The 718B and 718SHB come complete with a carrying bag with twin shoulder straps for backpack style carrying.

**718B Digi Tripod (BO718B)** .....**99.95**

**718SHB Compact Digi Tripod (BO718SHB)** .....**99.95**



718SHB Digi Tripod



718B Digi Tripod

## DIGI TRIPODS

### 725B Digi-Tripod

Designed for today's digital and conventional cameras, this lightweight and compact tripod offers all the rock steady support necessary for high quality imaging. Handsome black anodized legs and black painted castings reveal a tripod with features and an unbeatable price. The Digi 725B is a lightweight marvel that can meet any shooting need. The 725B incorporates a traditional quick release ball head with +90°/-90° portrait orientation grooves and single repositionable "ratchet" locking lever.

It comes complete with a carrying bag with twin shoulder straps for backpack style carrying. Ideal for fitting into luggage, four section tripod legs permit a folded length of just 19". Once on location, the 724B extends to over 5-ft. It weighs 3-lbs, and can support digital cameras up to 7.7 lbs.

**725B (BO725B) .....109.95**



### 728B Digi-Tripod

Ideally suited for small digital cameras, the 728B is a 4-section tripod that provides a stable platform for rock steady shots. Lightweight and compact, the legs are constructed of sturdy multi-faceted tubular aluminum that features new quick flip lever leg locks for fast set-up and breakdown. The shoulder of the tripod is made of cast aluminum to increase rigidity, and it incorporates a unique single hinge design which allows for a more compact leg section when folded. The center column is also reversible for low-angle shots, and the integrated 3-way head is also made of cast aluminum and features a quick release plate. Pan and tilt movements are extremely smooth. Includes a carry bag that sports twin shoulder straps for backpack-style carrying.

**728B (BO728B).....118.95**



Each of the Manfrotto Digi Tripods include a super convenient carry bag that sports twin shoulder straps for backpack-style carrying.

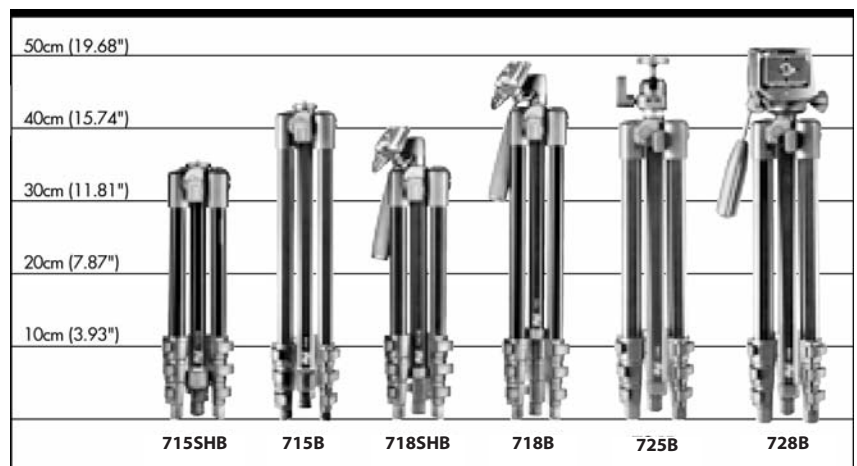

	Maximum Load	Maximum Height	Maximum Height with Column	Minimum Height	Closed Length	Weight
<b>709B/BR</b>	4.5 lbs	3.54"	N/A	N/A	6.69"	.2 lbs
<b>715B</b>	5.5 lbs	52.4"	64.2"	16"	17.3"	2.5 lbs
<b>715SHB</b>	5.5 lbs	38.3"	47.8"	12.8"	13.8"	2.22 lbs
<b>718B</b>	5.5 lbs	54.9"	65.5"	18.7"	19.3"	3.09 lbs
<b>718SHB</b>	5.5 lbs	41.2"	48.5"	15.6"	15.9"	2.74 lbs
<b>725B</b>	7.7 lbs	52"	64.5"	18.5"	20"	3.1 lbs
<b>728B</b>	7.7 lbs	52.4"	64.8"	19.1"	19.4"	3.86 lbs



## NEOTEC

*You're on an outdoor shoot running up against a tight deadline to get all the images you need; you've got no assistants getting your equipment ready for you; if you shoot handheld, you're going to be forced to select from a dwindling number of sharp photos as well as spend more time in post-production, but getting your tripod open, set up and levelled is going to take up precious moments of the remaining perfect light... sound familiar? So what would you give to have equipment that was on your side in crucial moments like that? The NeoTec tripod is awesomely fast and easy to use, with the most innovative rapid opening and closing mechanism available today - just pull each leg downwards to open and automatically lock it in any position - with no screws, knobs or levers to tighten or loosen. Then to fold it back up again, press the mechanism release button and push the leg closed. All in a matter of seconds.*

- ◆ NeoTec rapid opening and closing mechanism
- ◆ Two-part center column switches between normal and low-angle work, without forcing you to remove camera and head every time you need to change position
- ◆ Leg lock release button for closing the tripod or shortening each leg for perfect positioning
- ◆ Patented top casting allows horizontal setting of the center column for un usual angles and macro work
- ◆ Four set leg angle (25°, 43°, 73° and 90°) positions for a solid footing at any height
- ◆ Includes a detachable carrying handle, which can also be used to support a counterweight
- ◆ Waterproof up to 18" as the bottom leg section is sealed



**458B NeoTec Pro Photo Tripod (BO458B)**  
3-section tripod weighs 5.3 lbs., supports up to 17.6 lbs., extends to 61.4", minimum height is 3.9", closes to 25.2" .....**329.95**

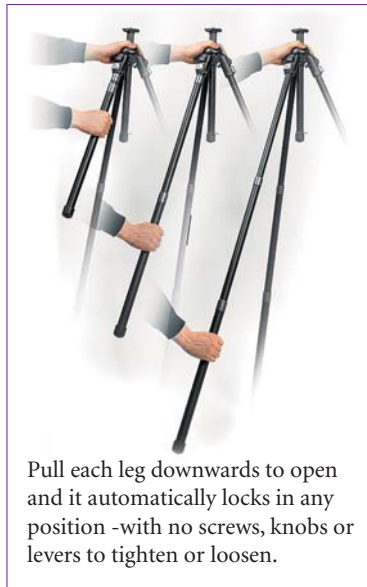

Pull each leg downwards to open and it automatically locks in any position -with no screws, knobs or levers to tighten or loosen.

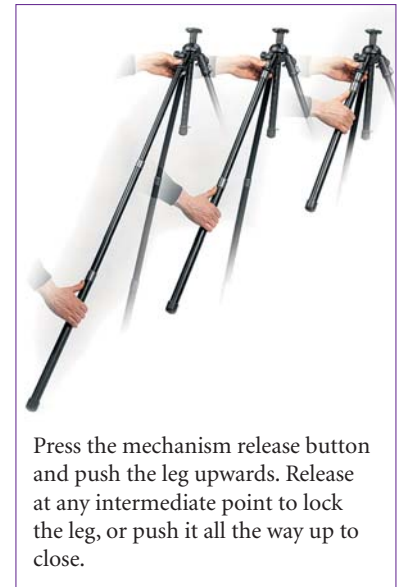

Press the mechanism release button and push the leg upwards. Release at any intermediate point to lock the leg, or push it all the way up to close.

Manfrotto's design team consciously ignored how most tripods work and thought instead about how a tripod should work, beginning with how easily and quickly it should be set up or how effortlessly it should close. At the heart of NeoTec lies an innovative mechanism which, hidden safely inside the leg and without any external levers or knobs, pushes outwards on the tubing to lock the leg in place at any extension. The mechanism exerts more locking power the heavier the weight pushing down on it from above. Beyond the extreme ease of use it offers you, NeoTec is also a workhorse tool for professional photographers - offering stable and strong support that can take the strain of constant use and safely bear the load of professional camera equipment. But it doesn't stop there, it also includes a built-in low angle adapter for the times when the center column length gets in your way, and a convenient handle for more comfortable carrying.

## TRIPODS

### 190XDB

#### Lightweight Tripod

Builds on the success of the 3001 series, but has been redesigned to offer better ergonomics of the leg-angle release mechanism. It can reach a maximum working height of 57.5", and folds up to 21". Redesigned more ergonomic flip locks, with only 45° of movement. Four leg-angle settings (25, 46, 66 & 88°). Ideal for use with cameras up to SLR size with medium pro zoom lens attached. Four leg-angle settings (25, 46, 66 and 88°). Weighs 3.7 lbs. and supports up to 11 lbs.

BO190XDB .....96.95

### 190XB

#### Lightweight Tripod

Built on the same ergonomically improved design as the 190XPROB but without the horizontal center column feature, the 190XB is lighter in weight and slightly more compact. While it can reach a maximum working height of 57.5", it can also be used as low as 3.3" by using the low angle adapter built-in to the center column. Leg warmers on 2 legs ease handling in extreme weather conditions, and help to protect the legs.

BO190XB.....124.95

BO190XV (Green) .....146.00

### 190XPROB

#### Lightweight Tripod

Newly redesigned, the 190XPROB makes the famous Manfrotto-patented horizontal center column feature even easier to use. Now, by extending the column to its highest vertical position, it can be swung round to horizontal without removing the head or disassembling the column itself, so switching between framing and positioning setups is more convenient than ever. The ergonomics of the leg angle release mechanism and the quick action leg locks themselves have also been greatly improved. Built-in low angle adapter for ground level shots. Leg warmers on two legs.

BO190XPROB.....144.95



### 3011N

#### Basic Tripod

Lightweight, sturdy, portable and easy to handle, this basic tripod is one of the easiest to handle. Designed for SLR-type film and digital cameras, it offers a long reversible center column for extra high adjustment with an innovative three faceted design that eliminates the problem of column rotation. It features a single-position leg spread, and leg collars with double wing locking knob. Maximum height is 54" (71.3" with center column extended). Minimum height is 22" and it folds to 24". Weighs 4.9 lbs. and can support up to 13 lbs.

BO3011N.....109.95

BO3011BN (Black) .....109.95

### 3021N

#### Professional Tripod

Features rapid action lever leg locks with just 45° movement for fast setup and added security, a variable height and reversible center column with three-faceted design that eliminates column rotation. It features 4-position leg angle settings (26°, 45°, 75°, 90°) and a low-angle adapter built into the center column for low level shots — only 3.1" from ground level. Includes foam rubber leg warmers on two legs to protect your hands in cold weather, and your body when carrying the tripod on your shoulder. Maximum height is 53" (70" with center column extended). Folds to 24". Weighs 5.1 lbs. and can support up to 15.4 lbs.

BO3021N.....148.95

BO3021BN .....148.95

### 3021 PRO

#### Professional Tripod

Same as the 3021N but even more versatile! With a center column designed as an alternative to the low-angle adapter, the head can be left mounted to the column when switching between low angle and normal shooting. In addition, the easily removeable center column doubles as a horizontal arm. Not only does this allow the camera to be offset from leg position, but it provides the simplest way possible to shoot from directly overhead. The top section of the center column is detached by simply unscrewing the knob at the bottom of the column. Includes foam rubber leg warmers on two legs to protect your hands and body.

BO3021P .....157.95

BO3021PB .....157.95



## TRIPODS

### 190MF & 055MF MagFiber Tripods

The revolutionary MagFiber tripods combine the strength of magnesium and carbon fiber. Each leg is crafted from carbon fiber using an exclusive process. Under intense pressure, extra long carbon fibers are combined with resin to produce a stronger tube that absorbs more vibration than any other tripod in its class; all with a wall thickness of only 1.2mm. Manfrotto engineers also replaced all aluminum tripod components with die-cast magnesium. This switch represents a lateral move in sturdiness yet a substantial gain in strength and reduction of weight by 30% over similar sized aluminum models.

- ◆ Carbon fiber three-faced tubes for the tripod legs; aluminum and nylon polymer center column. Magnesium die-casting (30% lighter than aluminum) for all tripod parts and stainless steel nuts and bolts
- ◆ Quick-action adjustable leg lever locks instantly secure leg extensions firmly in place with no slippage or rotation
- ◆ Push buttons to operate leg angles to offer four angle of inclination
- ◆ Center column converts in seconds to a lateral arm to provide table-top and overhead camera positions.
- ◆ Two-part center column switches between normal and low-angle work without having to remove the camera and head everytime you need to change position.
- ◆ Built-in low-angle adapter (easily detaches without any tool) forms the top section of the center column. This enables the head to be left mounted on the center column when switching between low-angle and normal shooting positions.
- ◆ Supplied hand padded carrying strap doubles as a hook to hang weight and increase stability during extreme wind conditions.

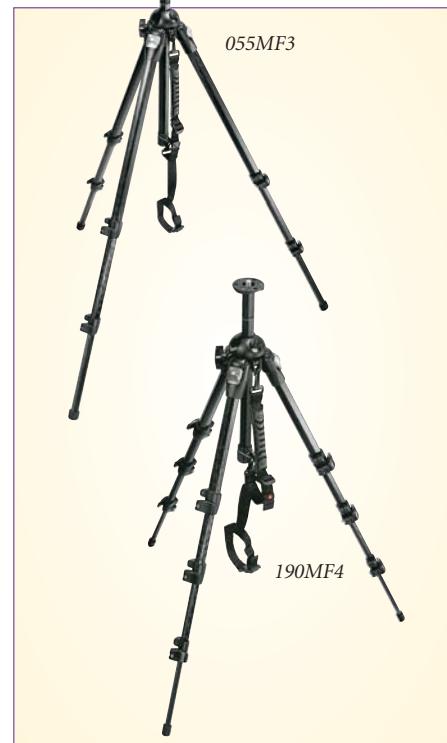

**190MF3 (BO190MF3):** 3-section tripod weighs 3.5 lbs., supports up to 8.8 lbs., extends to 56", minimum height is 4.3", closes to 22" .....**276.95**

**190MF4 (BO190MF4):** 4-section tripod weighs 3.5 lbs., supports up to 8.8 lbs., extends to 51.6", minimum height is 4.3", closes to 18.1" .....**288.95**

*A 'beefier' tripod to the 190MF series, the 055MF3 and 055MF4 are very light, simple to use, strong, and extremely versatile to position.*

**055MF3 (BO055MF3):** 3-section tripod weighs 4.4 lbs., supports up to 15.4 lbs., extends to 66.5", minimum height is 4.3", closes to 25.2" .....**315.95**

**055MF4 (BO055MF4):** 4-section tripod weighs 4.4 lbs., supports up to 15.4 lbs., extends to 65", minimum height is 4.3", closes to 21.3" .....**341.95**



475 Pro Geared  
Column Tripod

### 475 Pro Geared Column Tripod

The 475 Pro Geared Tripod offers an all aluminum construction, unrivalled stability, a unique center brace strut system, reliable quick-action leg locks, non-rollback three faceted center column, a spirit level and rubber/metal spiked feet. The 475 has a center brace system that can be operated in a symmetric or asymmetric way. This allows the best of both worlds: speed by locking the braces so that all of the legs will be spread to the same angle, or by individually setting the angle of each leg for the ultimate in tripod positioning.

To avoid annoying delays in leveling the tripod, the telescopic center braces have been designed with two "click stop" positions that allow you to easily find the same spread angle on all three legs. The 475 also incorporates Quick Action leg locks, which have an amazingly quick and secure locking range. All it takes is a 45° flip of the lever to lock and unlock each section.

**475 Chrome Tripod (BO475).....262.95**    **475B Black Tripod (BO475B).....262.95**

## TRIPODS

### 3046 Geared Column Tripod

Strong, sturdy and reliable, the 3046 tripod is the ideal studio tripod. The geared center column has a non roll-back feature and has a threaded 3/8" mount on the bottom of the column to allow low-angle shots. Twin shark leg design, built-in spirit level and rubber feet with retractable spikes are standard. Uses a center column strut design for added stability.

- 3046 Chrome Tripod (BO3046).....229.95
- 3246 Black Tripod (BO3046B) .....229.95

### 3051 Geared Column Tripod

Handling everything up to 4 x 5", this tripod is capable of extremely low camera position with the platform at only 17", yet has the ability to go up and stand over 7'. Features patented automatic simultaneous release of all three legs or any individual leg. This permits the legs to be extended, the tripod levelled (spirit level included) and locked in seconds without the need for individual leg adjustment. Closing the legs is achieved by activating the same release. Also has the ability to adjust all angles individually and secure them with Manfrotto telescopic struts. Rubber feet with retractable spiked feet are standard. The geared center has a non-rollback feature.

- 3051 Chrome Tripod (BO3051).....303.95
- 3251 Black Tripod (BO3051B) .....303.95

### 3058 Geared Column Tripod

The tallest tripod in the range, the 3058 is capable of providing a stable platform for cameras up to 44 lbs. at maximum height of almost 9' (105.2"). On the other hand this giant is also capable of a minimum height of just over 17". The geared center column is self locking. The legs are braced using telescopic struts for maximum rigidity and the ability to have individually adjustable and lockable angles. Rubber feet with retractable spiked feet and spirit level are standard equipment. Ideal for all large format cameras.

- 3058 Chrome Tripod (BO3058).....464.00
- 3258 Black Tripod (BO3058B) .....444.95



### 190X/3011/3021 TRIPODS

	Description	Maximum Load Capacity	Maximum Height with Extended Center Column	Minimum Height	Closed Length	Weight
190XB	Anodized Aluminum	11.1 lbs.	57.1"	3.1"	20.9"	3.9 lbs.
190XPRO	Anodized Aluminum	11.1 lbs.	57.1"	3.3"	22.1"	4.2 lbs.
3011N	Anodized Aluminum	13.3 lbs.	71.3"	22.1"	24.1"	4.9 lbs.
3021N	Anodized Aluminum	13.3 lbs.	70.1"	3.2"	24.1"	5.1 lbs.
3021PRO	Anodized Aluminum	13.3 lbs.	69.3"	4.4"	25.6"	5.3 lbs.

### 475/3046/3051/3058 GEARED COLUMN TRIPODS

	Description	Maximum Load Capacity	Maximum Height with Extended Center Column	Minimum Height	Closed Length	Weight
475 Pro	Aluminum	26.5 lbs.	74"	17"	31.5"	9.5 lbs.
3046	Anodized Aluminum	26.5 lbs.	89.4"	30.4"	32.3"	9.2 lbs.
3051	Anodized Aluminum	26.5 lbs.	85.5"	17.4"	37.1"	13.6 lbs.
3058	Anodized Aluminum	44.1 lbs.	105.1"	17.4"	41.4"	17.5 lbs.

## MONOPODS

The monopod is an underestimated means of photographic support. It is inexpensive, light to carry, takes little space, and is easy and fast to erect. Handled correctly, it supplies all the camera support you are likely to need, even for long lenses. Just look at the press and sports photographers—these pros wouldn't bother with them if they didn't get results.

**676B Digi  
4-Section Monopod**

A simple, easy to set up black anodized aluminum monopod. The four section leg design allows it to fold up to less than 20", and it weighs less than a pound. It features rapid-action flip locks for the leg extensions, strap, and a 1/4-20" screw.

**676B Black (BO676B).....30.95**

**685B Neotec  
Monopod Deluxe**

A fast and easy monopod, with the most innovative rapid opening and closing mechanism available today. Just pull the leg downwards to open and automatically lock in any position. No screws, knobs or levers to tighten or loosen. To close it back up again, press the release button and push the leg closed in a matter of seconds. Its mechanism exerts more locking power the heavier the weight pushing down on it from above. Its "upside down" construction stops the water you're standing in from ending up inside the monopod.

**685B Black (BO685B) .....130.95**

**681 Professional  
Monopod**

Robust 3-section monopod with a sure rubber grip, wrist carrying strap, large 2.3" platform with plastic cover and dual 1/4-20" - 3/8" camera screw. Quick-Action lever lock system with 45° flip allows sections to be quickly set-up and adjusted.

**681 Chrome (BO681) .....50.95**

**681B Black (BO681B) .....50.95**

**679 3-Section  
Monopod**

3-section monopod with sure-rubber grip, quick action lock levers, large 2.3" camera/head platform and dual 1/4 - 20" and 3/8" camera screw. Quick-Action lever lock system with 45° flip allows the sections to be quickly set-up and adjusted.

**679 Chrome (BO679).....41.95**

**679B Black (BO679B).....41.95**

**694/695  
MagFiber Monopods**

Mag Fiber monopods combine the strength of magnesium and carbon fiber. Extremely compact, they are crafted from carbon fiber using an exclusive, patented process. Under intense pressure, extra long carbon fibers are combined with resin to produce a stronger tube that absorbs more vibration - and with a wall thickness of only 1.2mm!

Manfrotto engineers also replaced all aluminum components with magnesium. They are user-friendly, with quick-action adjustable lever locks that instantly secure leg extensions in place with no slippage or rotation. They come with a wrist strap and camera platform with dual 1/4" and 3/8" camera fixing screw. The 4-section 694 has a maximum height of 65" and closes to 20.9". The 5-section 695 has a maximum height of 63" and closes to 18.1".

**694 4-Section (BO694) .....169.95**

**695 5-Section (BO695) .....198.95**

**682 Self-Standing  
Pro Monopod**

The 682 has all same features as the 681 Professional Monopod with the addition of 3 retractable legs. The three-section 682 monopod features a large 2.3" platform with a plastic cover and a dual 1/4-20" - 3/8" camera screw.

**682 Chrome (BO682).....97.95**

**682B Black (BO682B).....97.95**

**680 4-Section  
Compact Monopod**

Rubber grip, quick action lock levers, large 60mm camera/head platform and 1/4 - 20" and 3/8" camera fixing screw. Closes to 20". Quick-Action lever lock system with 45° flip allows the sections to be quickly set-up and adjusted.

**680 Chrome (BO680).....52.95**

**680B Black (BO680B).....52.95**

**3245 Automatic  
3-Section Monopod**

The upper section features a grip-action release that allows the top section to be adjusted 19" up or down automatically by squeezing and releasing the grip-action handle.

The lower two sections have a twist lock action for height adjustment. Dual 1/4 - 20" and 3/8" camera fixing screw.

**3245 Chrome (BO3245).....87.95**





## MONOPODS

### 3232 Swivel Tilt Head (BO3232)

Simple tilt head to allow a camera on a monopod to be turned 90° to provide either vertical or horizontal format .....19.95

### 3229 Swivel Tilt Head with Quick Release (BO3229)

Same as 3232 but with quick release camera plate and secondary safety lock .....30.95

### 3248 Shoulder Brace (BO3248)

Fits the top end of any monopod to give additional stability. Adjustable length with pivoting shoulder support .....21.95

### 678 Universal Folding Base (BO678)

Allows the addition of a base made of three foldable high strength steel legs to the monopods 679, 680, and 681. The legs can be folded and stored inside the bottom section of the monopod ready in a few seconds when needed .....49.95

### 3247 Monopod Belt Pouch (BO3247)

Worn on a belt, this easy to use pouch offers support for the base of a monopod .....14.95

### 449SPK2 Rubber/Stainless Steel Spiked Foot (BO449SP2)

Reversible spiked foot supplied with a dedicated fixing tool. The spike is made of a special hard stainless steel alloy extremely resistant to corrosion. For 3449 .....16.95

### 676SP2 Rubber/Stainless Steel Spiked Foot (BO676SP2)

Same as the above spiked foot, but for monopods 679 and 680 .....16.95

### 677SP2 Rubber/Stainless Steel Spiked Foot (BO677SP2)

Same as above, for 681 monopod .....16.95

### 449SC2 Suction Cup/Retractable Spike Foot (BO449SC2)

A rubber suction cup foot with retractable stainless steel spike. The suction cup increases the footprint of the monopod by almost 20 times, giving much greater stability when needed. The foot can be removed and replaced at will. For the 3449 .....28.95

### 676SC2 Suction Cup/Retractable Spike Foot (BO676SC2)

Same as above for the 679 and 680 .....24.95

### 3422 Monopod Support (BO3422)

Fixed on the monopod, adds two points of support making it stable on any surface regardless of the inclination. Allows long exposures on automatic release. Comes complete with the 3009 ballhead. Attachment - 3/8" female for monopod .....54.95

### 3421 Long Lens Monopod Bracket (BO3421)

Specifically developed for use with very long lenses on monopods. Key features: friction base which enables the bracket to pan on monopod, also can be used on a tripod. Two rubber hand grips plus rubber protection to prevent damage to lens when tilted to maximum. Variable center height adjustment in three steps .....172.95

### 3257 Spiked Foot for Monopod (BO3257)

Converts 679, 680 and 681 series monopods rubber foot to a spiked foot .....13.95

### 677SP Rubber/Spiked Foot (BO677SP)

Rubber foot for with retractable metal spike, for monopods 679, 680 and 681 .....16.95

### 677SC Suction Cup/Retractable Spike Foot (BO677SC)

A rubber suction cup foot with retractable stainless steel spike for the 681 monopod. The suction cup increases the footprint of the monopod by almost 20 times, giving much greater stability when needed. The foot can be removed and replaced at will .....28.50

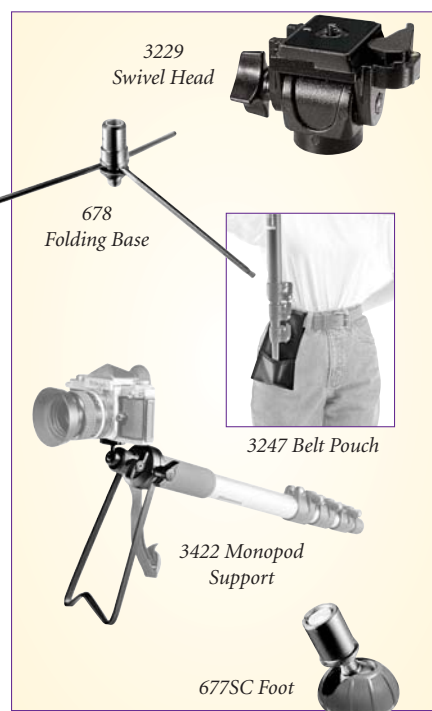

## MANFROTTO MONOPODS

	Sections	Minimum Height	Maximum Height	Weight	Load Capacity
676B	4	18.9"	60.6"	14.1 oz.	10 lbs.
679/679B	3	25.2"	63.8"	1.3 lbs.	22 lbs.
680/680B	4	20"	60.6"	1.8 lbs.	22 lbs.
681/681B	3	26.4"	63.4"	1.7 lbs.	26.4 lbs.
682/682B	3	29.1"	67.7"	2.4 lbs.	26.4 lbs.
684B	3	27.9"	65.6"	1.6 lbs.	17.6 lbs.
694	4	20.9"	65"	1.3 lbs.	11 lbs.
695	5	18.1"	63"	1.3 lbs.	11 lbs.
3245	3	26.7"	65.4"	1 lbs.	17.6 lbs.

## BALL HEADS

Manfrotto's comprehensive range of ball heads offer smooth movement and positioning of the camera, 360° panning movement plus 90° tilt, positive locking and quick release camera plate on some heads. Ball heads are favored over 3D heads when speed and compact size is important.

### 482 Micro Ball Head

Designed for use with small, compact cameras. The aluminum housing and extremely hard resin ball provides smooth movement. A single control lever locks the ball and pan movements. Ideal for the 3007 table top tripod, car window clamp 3293 or 3287 monopods and Super Clamp 2915 combined with 2907 adapter. Supplied with a large 50mm camera platform. 4.4 lb. maximum load.

BO482.....33.95

### 484 Mini Ball Head

Designed with the SLR photographer in mind, the 484 Mini Ball Head features a strong die-cast construction, precision machined aluminum housing, and an extremely hard phenolic resin ball which provides smoother movements across all tilt positions. The double-groove also makes this head extremely versatile, and the single ratchet control lever securely locks both the ±90° ball and 360° pan movements. Camera attachment is via a 2" platform with a 1/4-20" male thread, and head to tripod attachment is 3/8" female. Maximum load is 8.8 lb.

BO484.....40.95

### 484RC2 Mini Ball Head

Same as the 484, except this versatile head is fitted with a 3157N quick-release camera plate with a secondary safety catch. This head is perfect for 35mm SLR cameras with medium lenses, and light medium format cameras. Incorporates a spring-loaded, retractable dual thread (both 1/4-20" and 3/8") for your camera and tripod mount, and features single lever operation. It accepts a maximum load of 8.8 lbs.

BO484RC2 .....54.95

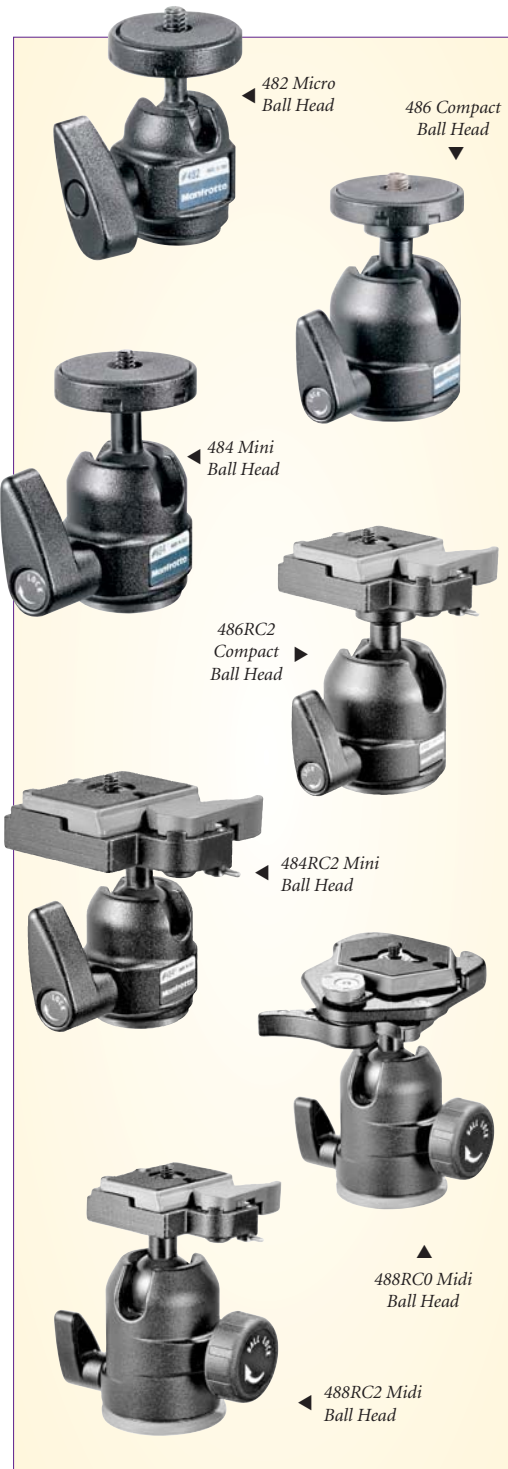

### 486 Compact Ball Head

Compact, yet strong enough to support heavier camera loads. Strong die-cast construction, precision machined aluminum housing, and an extremely hard phenolic resin ball provides smooth movements across all tilt positions. Has a single ratchet locking knob for 360° pan and a double groove for ±90° tilt movements. Camera attachment is via a 2" platform with a 1/4-20" thread. 13.2 lb. maximum load.

BO486.....56.95

### 486RC2 Compact Ball Head

Same as the 486 but equipped with a 3157N quick-release camera plate.

BO486RC2 .....64.95

### 488 Midi Ball Head

With solid aluminum construction and phenolic resin ball, the 488 head has a maximum load of 17.6 lbs. Has a double-groove for rapid side-to-side movement, and a separate fast-action ratchet lever for 360° pan and easy grip locking knob for ±90° tilt movements. 2" camera platform with a 1/4-20" male thread.

BO488.....82.95

### 488RC0 Midi Ball Head

Same as the 488 but equipped with a 3049 quick-release camera plate with a secondary safety catch and two spirit levels for precise levelling on both vertical or horizontal axis. It features a separate fast action ratchet lever for 360° pan and an easy to grip locking knob for ±90° tilt movements.

BO488RC0 .....100.95

### 488RC2 Midi Ball Head

Same as the 488 but with a 3157N quick-release camera plate with a secondary safety catch. Features a separate fast action ratchet lever for 360° pan and an easy to grip locking knob for ±90° tilt movements.

BO488RC2 .....100.95

### 488RC4 Midi Ball Head

Same as the 488 but with a 3271 quick-release camera plate with a secondary safety catch and two spirit levels for precise levelling on both vertical or horizontal axis.

BO488RC4 .....105.95

## BALL HEADS

### 490 Maxi Ball Head

The top of Manfrotto's ball head line, the 490 is made in die-cast aluminum with a precision phenol resin ball. Separate locks on 360° pan and ±90° tilt movements, with an additional friction control on the ball movement, gives just the right resistance and smoothness with minimum effort, even when varying weights of equipment. The 490 attaches to the camera via a 2" platform with a combined 1/4-20" and 3/8" male thread. Maximum load is 26.4 lbs.

BO490.....170.95

### 490RC4 Maxi Ball Head

Same as the 490 but equipped with a 3271 quick-release camera plate with a secondary safety catch and two spirit levels for precise levelling on both vertical or horizontal axis.

BO490RC4.....188.95

### 3265 Grip Action Ball Head

Versatile, quick and easy to use. Just grip the handle and you can position your camera anywhere within a 180° sphere. Supplied with a quick release assembly, camera plate with secondary safety catch, built-in bubble level and tension adjustment. Made of cast aluminum, this head is ideal for cameras with short or medium focal length lenses. 1/4-20" camera attachment. 5.5 lb. maximum load.

BO3265.....90.95

### 322RC2 Horizontal Grip Action Ball Head

Take the versatility of a ball head, add true ergonomic control and you get the 322RC2. The revolutionary 322RC2 allows you to unblock, move, position and lock your camera with one hand in one position. A friction control wheel lets you regulate the power of the blocking mechanism to match the weight of your camera and lens. The 322RC2 is made from magnesium for lightweight performance, and is designed to keep the weight of your equipment as close as possible to the tripod's center of gravity by way of its reduced height. Includes a built-in bubble spirit level and quick release camera plate (1/4 - 20" screw, with secondary safety pin). Load capacity is 11 lbs (5.5 lbs in the vertical position).

In addition, mount the 322RS remote control electronic camera shutter release, and the 322RC2 puts camera control within reach without having to move your hand from the head grip to the camera body.

BO322RC2.....109.95



### 468MG Series Hydrostatic Ball Heads

The 468MG Hydrostatic Ball Head range features an unmatched advanced friction and locking mechanism. Just a slight turn of the locking knob applies enough pressure to firmly hold the camera. When it's time to move the camera, it's just as easy to unlock, and with adjustable friction set, your camera will never get away from you.

These heads incorporate an advanced ball locking mechanism using hydrostatic action. Based on principles of modern hydraulics where force that is applied at one point is transmitted to another point using an incompressible fluid, the locking process is improved using a special liquid inserted in the internal chamber. When pressure is applied, the liquid blocks the movement of the ball. Because the force exerted by the liquid is more constant and evenly distributed, locking power is dramatically improved.

The camera and head move in unison with no headway effect during the locking phase. The heads also have a calibrated, adjustable tension control allowing the ball tension to be preset for various camera weights.

In addition, they each feature an independent pan and tilt lock with 360° pan movement and ±90° tilt movement. The body of each head is constructed in magnesium die casting with a 2" Teflon coated aluminum ball, enabling smoother camera movements.

**468MG:** Weighs 1.4 lbs and has a maximum load of 35.3 lbs. (BO468MG).....283.95

**468MGRC0:** With RCO Rapid Connect System, weighs 1.9 lbs and has a maximum load of 35.3 lbs. (BO468MGRC0).....315.95

**468MGRC2:** With RC2 Rapid Connect System, weighs 1.4 lbs and has a maximum load of 22 lbs. (BO468MGRC2).....294.95

**468MGRC3:** With RC3 Rapid Connect System, weighs 1.8 lbs and has a maximum load of 35.3 lbs. (BO468MGRC3).....328.95

**468MGRC4:** With RC4 Rapid Connect System, weighs 1.6 lbs and has a maximum load of 35.3 lbs. (BO468MGRC4).....323.95

**468MGRC5:** With RC5 Rapid Connect System, weighs 1.6 lbs and has a maximum load of 26.5 lbs. (BO468MGRC5).....328.95



## 3-WAY HEADS

A tripod head is just as important as a tripod. It is necessary to match the task of the tripod, head and camera. For this reason, Manfrotto offers a wide range of heads designed to carry loads from ultra-lightweight up to 26 lbs. Manfrotto's 3-Way Heads are precision-engineered to provide smooth and independent control of pan, backward and forward tilt, plus side-to-side tilt movements. In fact, the camera position can rapidly change from landscape (horizontal) to portrait (vertical) or adjust to the appropriate angle that best suits the shot. Large rubber grips on the pan and tilt handles provide efficient control. All heads come supplied with standard 1/4-20" threaded camera screw.

### 3437 3D Magnesium Head (BO3437)

Cast from lightweight magnesium, this innovative 3D head can be positioned in virtual any position to get the exact framing of the image. Lock-system using spring-loaded conical joint allows greater flexibility than any other 3D head whether mounted on a tripod center column or lateral arm. The rubber grip knobs provide fingertip control and won't poke you in the eye like conventional handles do. Supports up to 6.6 lbs.....**90.95**

### 3025 3D Junior Head (BO3025)

A self-adjusting conical bearing locking system allows 360° rotation on both the vertical and horizontal plane. This is the ideal head for SLR and lens up to 6.6 lbs.....**27.95**

### 804RC2 3-Way Pan/Tilt Head with RC-2 Quick Release (BO804RC2)

Full 3-way action with each axis movement controlled by a separate locking handle. Incorporates a quick-release plate with safety lock to make camera changes as easy as flipping a lever. The 804RC2 head is also the first 3-way head to use a counter spring system to help protect your equipment. Handles up to 13.2 lbs. ....**64.00**



### 808RC4 3-Way Pan/Tilt Head with RC-4 Quick Release (BO808RC4)

This 3-way pan head handles up to 17.5 lbs. and includes the Double Axis Spring System which consists of a built-in 3.3 lb spring for both the front tilt and side tilt movements. This innovative solution, borrowed from the video industry, helps to move the camera smoothly while framing the picture, as it helps to balance some of the camera weight. In addition, it absorbs the shock to bodies and lenses when reaching the end stop of the head movement.

Modernized overall shape and many of the hard edges have been rounded to produce a fresh and elegant product. Coating on the quick-release lever is durable and scratch resistant. Handles to fit comfortably in the hand, even taking into consideration the size of fingers.....**116.95**

### 3039 Super Pro Head with Quick Release (BO3039)

Finely machined for greater positioning with smooth, certain action. 3 built-in spirit levels for horizontal and vertical control. A quick release camera plate with a secondary safety catch offers added security. Handles up to 26 lbs.....**183.95**

## GEARED HEADS



### 3263 Deluxe Geared Head (BO3263)

This unique head offers precise geared movement in three directions. Separate fold away rotating handles for pan and tilt and side-to-side leveling. In addition, the tension holding the round quick release plate can be released to allow fine adjustment with complete safety. Designed to mount on larger tripods, this geared head is for medium format cameras providing the ultimate in fine adjustment and control to achieve the exact framing required. Includes three 1/4-20" screws for camera attachment.....**624.95**

### 3275 (410) Compact Geared Head (BO3275)

Extremely compact, this unique head offers gear movement in three directions, pan, tilt and side-to-side tilt. It incorporates a quick release camera plate system and is suitable for SLR cameras. Maximum load capacity is 11 lbs.....**193.95**



### 405 Pro Digital Geared Head (BO405)



The 405 Pro Digital Geared Head is designed for digital photographers who shoot with camera/back payloads up to 16.5 lbs. The 405 utilizes large, easy-to-grip knobs that provide smooth, positive, geared control through 360° pan and +90° - 30° frontal and lateral tilt. In addition to its 3-D geared functions, the 405 also allows you to instantly disengage the gears and rough position the camera by hand, then instantly reengage them for ultra-precise final alignment. The 405 comes complete with quick-release plate, 1/4" and 3/8" camera mounting screws, and 3/8" tripod mount .....**366.95**

**QTVR SYSTEMS**

**300N Panoramic Head**

This head lets you set 10 different angles of rotation: (5, 10, 15, 18, 20, 24, 30, 36, 45, 60, 90°) or the number of shots (37, 36, 24, 20, 18, 15, 12, 10, 8, 6, 4 shots) spanning 360° rotation using the engraved, graduated scale markings for reference. The head can be used for precise sequential and constant angle shots or simply for panning and reading the angle of motion. The camera can mount directly to the head with the optional 3054 1/4" adapter or on any Ball or 3D head which mounts on the Panoramic Head.



BO300N .....170.95

**303 QTVR Panoramic Head Kit (BO303)**

Designed for QuickTime virtual reality technology which allows virtual scenes to be created by computer from panoramic digital or digitized images obtained from single shots stitched together. Suitable for most SLR and digital still cameras using wide-angle lenses. The kit includes a leveling base enabling fine, fingertip adjustment of  $\pm 5^\circ$  to ensure the camera is perfectly level, the 303 Panoramic Head, and an elbow bracket to ensure the optical center of the lens is above the point of rotation to avoid parallax errors and ensure perfect QTVR sequence. The kit features double sliding plate with 3.1" of adjustment for precise positioning, spirit level and graduated scale to set the angle of rotation from 10° to 90° or the number of shots spanning 360° .....341.95

**303 Plus (BO303P)**

Similar to the 303 but it incorporates precise geared movement of the 2 sliding plates used to position the camera on the panoramic axis of rotation. A release button disengages the gear to facilitate rapid movement of the plates when required .....400.95



**303SPH QTVR SPHERICAL PANORAMIC HEAD KIT**

*The 303SPH is a multi-row (spherical) panoramic photography head. It has sliding plates to position the camera over the panoramic axis of rotation, plus a sliding plate which rotates around the front/back tilt axis. This allows the camera to be rotated on both horizontal and vertical axis around the camera/lens nodal point, so multi-row panoramic photo sequences (cubic VR photos) can be taken accurately and easily.*

*Using the 303SPH ensures that software used for photo stitching produces a precisely composed VR environment with minimum post-production intervention or software correction.*

*The 303SPH's vertical bracket can be unlocked and rotated through 90° (then re-locked) so that the head takes up less space in transport, and so that the sliding plate mechanisms are protected against knocks and bumps. The 303SPH comes complete with an extra set of sliding plates for use with cameras of different sizes.*



- ◆ Three sliding plates for precise nodal point positioning on all planes/axes.
- ◆ Short plates included for more convenient use with compact cameras.
- ◆ Long plates included for use with larger SLR or medium format cameras.
- ◆ Camera attachment via 1/4 - 20" and 3/8" male screw.

- ◆ 3/8" female tripod fitting.
- ◆ Dual graduated scale to set the angle of rotation to any of the following:  
 90°, 60°, 45°, 36°, 30°, 24°, 20°, 15°, 10°, 5° (respectively equivalent to 4, 6, 8, 10, 12, 15, 18, 24, 36, 72 photos to achieve a full 360° rotation) - on upper part of 300N rotation unit.

- ◆ Graduated scale from 0° to 360° on lower part of 300N rotation unit.
- ◆ By removing vertical brackets, the 303SPH can also be used as an object turntable.
- ◆ Vertical bracket folds down and removes for compact size during transport.

## TRIPOD ACCESSORIES

**3288 Elbow Bracket** (BO3288)

The "Elbow Bracket" enables one to rapidly change from a horizontal to a vertical shooting position, without having to reposition the tripod and to keep an axis of vision which is vertical to the tripod itself, thus avoiding the threat of tilting. Compatible with the following heads: 3047, 3039 and 488RC0. Comes complete with 1/4-20" to 3/8" screws.....**59.95**

**341 Junior Elbow Bracket** (BO341)

Enables you to rapidly change from a horizontal to a vertical shooting axis, without having to reposition the tripod. Its adjustable stop prevents accidental camera rotation. Great for small & medium sized cameras with telephoto lenses. Use on all heads equipped with the 3157N type of camera plate, including: 3030, 3265, 3437, 468RC2, 486RC2, 488RC2, 468RC2.....**58.50**

**155RC Double Ball Joint Head with Quick Release Adapter** (BO155RC)

Not strictly a tripod head, but an extremely versatile support for compact and 35mm cameras used in conjunction with the 2915 Super Clamp. Supplied with quick release plate and secondary safety lock.....**49.95**

**2929QR Variable Friction Magic Arm with Quick Release Plate** (BO2929QR)

Articulated arm with large locking knob, variable friction and locking of arm is done by adjusting the knob. Supplied with quick release camera plate with secondary safety lock. Ideal for mounting a camera exactly at the angle you need it. Fits any 5/8" female socket, works especially well with 2915 Super Clamp. ....**112.95**

**2930QR Magic Arm with Quick Release Plate** (BO2930QR)

Your extra arm in the studio. One lever locks three pivot points. Supplied with a quick release camera plate with a secondary lock. Ideal for mounting a camera exactly the angle you need it. Fits any 5/8" female socket, works great with 2915 Super Clamp.....**109.95**

**3502 Ball Camera Leveller** (BO3502)

Weighing 1.4 lbs. and capable of holding 33 lbs., the 3502 provides fast leveling for tripods without built-in levels. Fits between the center column and head and has 10° of adjustment .....**73.95**

**3419 Micro Positioning Plate** (BO3419)

Ideal for macro photography to make precise positioning movements, for QTVR and other precise copy/repro work, the sliding plate has finger tip control for ultra-fine positioning – but with a simple lock-release lever for fast set-up. Two plates can be interlocked at 90° for full lateral/ forward/back movement (over 4.7"). In extruded aluminum, the plate has 1/4-20" and 3/8" holes and screws for tripod and camera mounting. ....**89.95**

**3500 Pump Cup with Flat Base** (BO3500)

A suction cup for lightweight equipment. The disc's diameter is 2.3", it weighs 1.36 lbs. and has a 3/8" thread to accommodate most any Manfrotto head .....**69.95**

**3289 Suction Grip with Camera Support** (BO3289)

Attaches to most non-porous surfaces. Ideal camera support in automobile or next to a window. Incorporates a separate brace that is designed to go down to the car floor for added stability .....**106.50**

**3292 Car Window Pod** (BO3292)

Clamps onto car window, with a 3/8" thread to accept small or medium sized Manfrotto heads.....**26.95**

**3292 Car Window Pod with 3-Way Pan/Tilt Head with Quick Release** (BO3292390RC2)

This kit combines the 3292 Pod with the 390RC2 3-way pan/tilt head.....**79.95**

**241 (3294) Suction Grip with Socket** (BO241)

Suction cup for small fixtures and lightweight equipment .....**63.95**

**2915 Super Clamp** (BO2915)

This universal clamp can be securely mounted on any tube from 0.5 to 2.1". Attachment is 5/8" hexagonal socket. It includes a wedge adapter to allow clamping onto a flat surface.....**24.95**

**2934 3/8" Head Mounting Plate** (BO2934)

Allows use of 3/8" camera mounting plate into 16mm socket. Compatible with 2915 Super Clamp and 484RC2 or 486RC2 Ball Head for example.....**17.95**

**208Hex Head Mounting Plate** (BO208HEX)

Same as 2934 Head Mounting Plate with a 3/8" thread Hex stud .....**21.95**



## TRIPOD ACCESSORIES

### 3287 Photo Clamp (BO3287)

Used to attach your camera to hard-to-get-to places. Can be fixed to surfaces up to 2.3" thick. Has 2x 3/8" male threads for mounting ball head and camera.....**29.50**

### 3430 Leg Protectors (BO3430)

Set of three leg protectors (14" long) with a zip system so they can be easily fitted and won't slip down when in use. Offers good grip. Protect the legs and insulate your hands when using the tripods in cold weather. For 3011N, 3021N and 3021PRO .....**31.95**

### 3431 Leg Protectors (BO3431)

Same as above except 10" long. Fits the 3001N, 3001D and 3001PRO tripods.....**33.95**

### 233B Camera Bracket (BO233B)

Camera flash bracket with telescopic column from 11.8" to 17.7" .....**56.95**

### 3276 Table Mount Camera Support (BO3276)

A simple table mounting support with three holes for fixing or clamping.....**45.95**

### 3278B Macro Flash Bracket (BO3278B)

Allows two shoe mount flash heads to be mounted with a camera onto a tripod head. Attachments: 3/8" and 1/4"-20" female threads and 1/4"-20" camera screw. Allows horizontal or vertical camera position .....**49.95**

### 337 Hot Shoe Two-Axis Bubble Level (BO337)

A double axis spirit level that mounts effortlessly to the hot shoe of any standard 35mm SLR camera to help you achieve a finer degree of accuracy in capturing image content. Ideal during QTVR shooting sessions.....**35.95**

### 3420 Telephoto Lens Support (BO3420)

Support for medium telephoto lens. The length of the bracket is adjustable to take different length lenses and different diameters by tilting the included 3229 Tilt Head. Length of the lens support is adjustable from 7.8 to 11.6". Attachments: 4 x 3/8" female and 3 x 1/4"-20" female .....**64.95**

### 3252 Super Telephoto Support (BO3252)

A very useful addition to any photographers accessory bag. Complete with Super Clamp 2915 and Mini Ball Head 482. Fully adjustable between 15.7" and 23.6" with a simple telescopic locking device .....**54.95**



3420 Telephoto Lens Support



3252 Super Telephoto Support



233B Camera Bracket

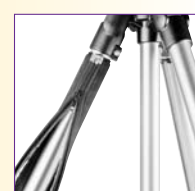

3430 Leg Protectors



337 Hot Shoe Two-Axis Bubble Level



3295 Anti-Theft Plate



3278B Macro Flash Bracket

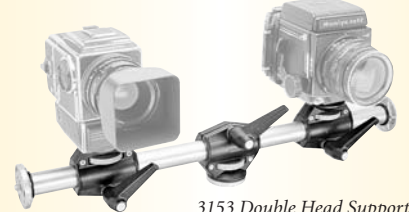

3153 Double Head Support

### 3424 Column Clamp (BO3424)

Versatile clamp designed to work in conjunction with removable tripod columns of between .98" to 1.1" diameter, such as the 3001 and 3021 Series tripods. It can be securely fixed to solid surfaces or bars up to 2.1" width. The column with head is inserted into the clamp and locked in position at the required height. The ideal accessory for nature photography or support for binoculars and scopes.....**67.95**

### 3253 Table Mount Geared Column with Clamp (BO3253)

Geared column with clamp for table thickness from 8-1.5", for supporting a camera adjustable between 2" and 26". Head not included.....**137.95**

### 3059 Accessory Side Arm (BO3059)

Mounts on any column with 3/8" thread, this side arm allows positioning of two heads at a 90° perpendicular to the tripod column. 23" long. Chrome color.....**53.95**

### 3059B Accessory Side Arm (BO3059B)

Same as above in black color .....**53.95**

### 3153 Double Head Support (BO3153)

Similar to the 3059 with the addition of two adjustable head mounts on the side arm allowing the possible mounting of four heads. 23" long. chrome.....**79.95**

### 3153B Double Head Support (BO3153B)

Same as above in black color .....**84.95**

### 3269 Double Camera Support Platform (BO3269)

Measures 11 x 2 1/2". Designed to fit any tripod head. Has 3/8" female socket. Allows you to mount two cameras on a single head. Supplied with two 1/4" and two 3/8" camera fixing screws.....**55.95**

### Apron Support (BO3146)

Attaches to tripod legs and allows for storage space beneath the center column. It can also be used to hold a sandbag or stones for extra support. Fits most Manfrotto tripods .....**28.95**

### 3295 Anti-Theft Plate (BO3295)

For heads with hexagonal plates. Key lock system for camera release. 78" steel cable.....**61.95**

## TRIPOD ACCESSORIES

## Tripod Feet

**Rubber/Metal Spiked Feet**

Reversible rubber/metal spiked feet supplied with a dedicated fixing tool. The spike is made of a special hard stainless steel alloy extremely resistant to corrosion.

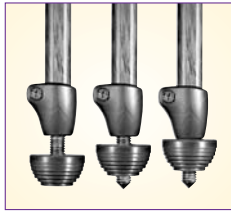

**Retractable Spiked Feet (BO055SPK2):** Set of 3, for 3011N, 3021N and 3021PRO .....**28.95**

**Retractable Spiked Feet (BO190SPK2):** Set of 3, for 3001N, 3001D and 3001PRO .....**31.95**

**Retractable Spiked Feet (BO440SPK2):** Set of 3 for 3444.....**32.95**

**Retractable Spiked Feet (BO441SPK2):** Set of 3 for 3443.....**33.95**

**Suction Cup/Retractable Spike Feet**

A rubber suction cup feet with retractable stainless steel spike. The suction cup increases the footprint of the tripod by almost 20 times, giving much greater stability when needed. The feet can be removed and replaced at will.

**Suction Cup Set (BO055SCK2):** Set of 3, for 3011N, 3021N and 3021PRO .....**52.95**

**Suction Cup Set (BO190SCK2):** Set of 3, for 3001N, 3001D and 3001PRO .....**52.95**

**Suction Cup Set (BO440SCK2):**  
Set of 3 for 3444 .....**52.95**

**Suction Cup Set (BO441SCK2):**  
Set of 3 for 3443 .....**52.95**

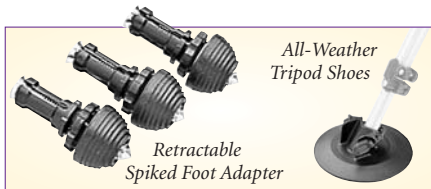

**Retractable Spiked Foot Adapter (BO055SPK):** Reversible rubber/metal spike feet (set of 3) as accessory for tripods 3011N, 3021N, 3021PRO, 3001N, 3001D and 3001PRO.**28.95**

**All-Weather Tripod Shoes (BO230):** Attach to tripod feet or monopods to provide stability in snow, mud or soft ground. For tripods 3011N, 3021N, 3021PRO, 3001N, 3001D and 3001PRO .....**19.95**

## Levelling Center Columns

This innovative system means you can quickly level your photo or video head without needing to make time-consuming adjustments to the length and angle of each single tripod leg. One of the most common problems in still photography and, above all, video has been resolved by Manfrotto, thanks to the use of a 50mm diameter leveling half ball mounted at the top of a tripod center column so as to make the angle of the top plate independent of the rest of the tripod. Locking and unlocking of the half ball is via a turning grip on the bottom of the center column. The half ball-mounting plate has a male 3/8" screw for attachment to a photo or video head, and a bubble spirit level for added ease of use.



**554 Leveling Center Column (BO554):** Carbon fiber version for 3444 and 3443 tripods.....**192.50**

**555B Leveling Center Column (BO555B):** Aluminum version for 3021PRO tripod .....**114.95**

**556B Leveling Center Column (BO556B):** Aluminum version for 3001PRO tripod .....**101.95**

## Short Columns

To improve the positioning flexibility of your tripods, shorter center columns are available as an accessory. If you need to work with legs set at the third or fourth angle of inclination (about 60°) but still require the possibility to move the camera up and down to achieve perfect adjustment for the shot, this shorter column replaces the one supplied with the tripod.

**6.9" Short Column (BO055CCSB):**  
For 3011N, 3021N, 3021PRO tripods.....**29.95**

**6.5" Short Column (BO190CCSB):**  
For 3001N, 3001D, 3001PRO tripods .....**29.95**

**6.5" Short Column (BO445CCS):** For Carbon Fiber series tripods .....**49.50**

**3007KIT Tabletop Tripod Kit (BO3007K)**

Small and portable, this kit fits into any camera bag ready to give quick support to a lightweight camera. The kit includes a 482 Mini Ball Head, a 3007 TableTop Tripod, an extension and a tripod pouch. The pouch easily attaches to your belt and has a Velcro fold over flap to secure the kits safely.....**73.95**

**3504 Tool Kit (BO3504)**

A set of tools to adjust the locking collars of most Bogen/Manfrotto tripods, stands and monopods. The kit includes a screwdriver and a hexagonal tubular socket.....**28.50**



## TRIPOD ACCESSORIES

### Plates

**Rapid Connect Hexagonal Plate (BO3041)**  
With 1/4-20" flush mount .....17.50

**Rapid Connect Hexagonal Plate (BO3042)**  
Same as above except with 3/8" screw.....17.50

**Rapid Connect Hexagonal Plate (BO3049)**  
For quick-release system. Supplied with 1/4" camera screw .....17.95

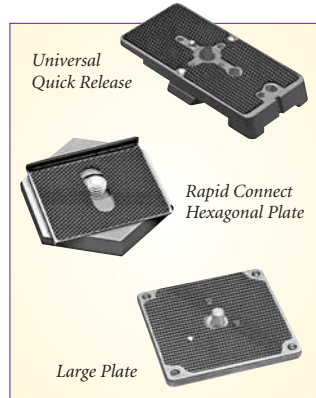

**Rapid Connect Hexagonal Plate (BO3048)**  
Same as above except with 3/8" screw .....17.50

**Rapid Connect Hexagonal Plate (BO3267)**  
This plate provides proper alignment for 90° vertical architectural shots with 35mm cameras. Supplied with 1/4"-20 camera screw .....21.95

**Rapid Connect Hexagonal Plate (BO3267A)**  
Same as above except with 3/8" screw .....21.95

**Rapid Connect Rectangular Plate**  
For quick-release system. Available with 1/4"-20 camera screw (BO3157N) or 3/8" screw (3157AN) .....11.95

**Rapid Connect Architectural Rectangular Plate (BO3157NR)**  
Provides proper camera alignment for 90° vertical architectural shots with 35mm cameras. Supplied with 1/4"-20 camera screw. ....19.95

**Rapid Connect Architectural Rectangular Plate (3157ANR):**  
Same as above except with 3/8" screw .....19.50

**Large Plate (BO3297)**  
Large 4x4" platform accept hexagonal quick-release plates. Supplied with 1/4-20" and 3/8" screw.....32.50

**Universal Quick Release Rectangular Plate for Hexagonal Quick Release Heads (BO3030U)**  
Supplied with both 1/4-20" and 3/8" screw .....26.9-5

**Dove Tail Accessory Plate (BO384PL14)**  
Supplied with 1/4-20" screw .....16.95

**Dove Tail Architectural Plate (BO384PLA14)**  
Provides alignment for 90° shots with SLR cameras. Supplied with 1/4"-20 screw.....19.95

**Rapid Connect Mounting Plate (BO3271)**  
With 1/4-20" and 3/8" fixing screws .....14.95

**Rapid Connect Adapter Assembly with Sliding Mounting Plate (BO577)**  
Supplied with 1/4-20" and 3/8" camera screws. Includes 3433PL slide plate.....52.95

### Quick Release Adapters

**Rapid Connect Adapter (BO625):** Hexagonal plate adapter supplied with 1/4-20" and 3/8" camera fixing screws. Fixing 1/4-20" and 3/8" thread. Includes 3049 hexagonal plate. Equipped with two built-in spirit levels .....49.95

**Compact Rapid Connect Adapter (BO3299):** Rectangular plate adapter supplied with 1/4-20" and 3/8" camera fixing screws. Fixing 1/4-20" and 3/8" thread. Includes 3157M rectangular plate...26.95

**Dove Tail Rapid Connect Adapter (BO384):** Supplied with 1/4-20" and 3/8" camera fixing screws. Fixing 1/4-20" and 3/8" thread. Includes both the Dove Tail Accessory Plate and Architectural plates .....54.95

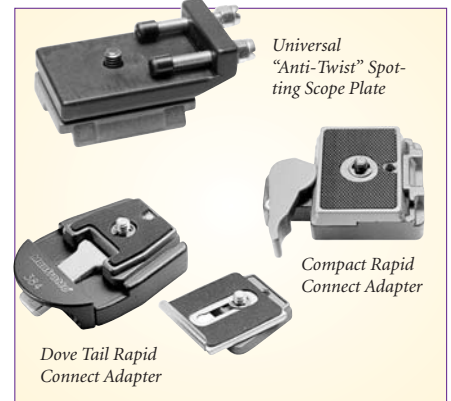

**Low Profile Rectangular Rapid Connect Adapter (BO394):** Plate adapter supplied with 1/4-20" and 3/8" camera fixing screws. Fixing 1/4-20" and 3/8" thread. Includes 3271 plate. Equipped with two built-in spirit levels .....39.95

**Universal Sliding Plate (BO3273):** Supplied with 1/4-20" and 3/8" camera fixing screws. Fixing 1/4-20" and 3/8" thread. Includes 3272 sliding plate.....39.95

**Universal "Anti-Twist" Spotting Scope Plate (BO200USS):** Eliminates unwanted rotation of the spotting scope during viewing. It has a standard 1/4" screw, and two grub set screws to lock the spotting scope securely in position .....59.95

### Adapters



**2907 Camera Mounting Stud (BO2907):**  
Reversible stud with 3/8" and 1/4". To mount cameras flush on the 2915 Super Clamp .....2.99

**3367 Small Adapter (BO3367):**  
Female 1/4-20" to male 3/8" adapter with flange .....6.95

**3298 Nikon Flash Adapter (BO3298):**  
Converts Nikon flash mount to universal flash bracket .....6.95

**3428 Survey Adapter (BO3428):**  
Converts tripod head screw from 3/8" threads to 5/8" .....33.50

**3049LS Metz Flash Screw (BO3049LS):**  
A special long 1/4-20" camera screw used in conjunction with the hexagonal 3049 camera plate which allows you to fit the Metz flash bracket .....7.95

**3054 Converter Plate (BO3054):** Converts tripod head screw from 3/8" to 1/4-20". Allows any Manfrotto tripod to accept heads with 1/4-20" socket. ....14.95

**3154 Joint for Arms (BO3154):** Double female 3/8" adapter allows using accessory arms 3059 and 3153 as column extensions.....17.50

**2932 Flash Shoe (BO2932):** Flash shoe with 1/4-20" male thread attachment .....6.95



## TRIPOD BAGS & CARRYING SYSTEMS

A tripod is a wonderful thing. Carrying one has never been — until now. Manfrotto has developed a complete range of carrying and transportation solutions designed around the tripod. These contoured bags



are worked from the inside out to fit your kit. They offer convenient ways of setting up and breaking down faster, a “space pad” that lets you shoulder carry your tripod without risking bangs and bruises, and an open backpack that keeps your hands free. Whether you want a handle or strap that doesn’t have to be removed from your tripod when you set up a shoot, or whether you need a protective shell to keep your tripod safe, Manfrotto has the solution. With innovative technical features, prime materials and first class construction methods, the quality of their bags are up to the high standards you expect from Manfrotto.

### PADDED TRIPOD BAGS



#### 47.2" Padded Tripod Bag (BOMBAG120P)

A ballistic nylon asymmetric tapered tripod bag that allows you to store the tripod with the head attached. The tripod legs fit comfortably in the

narrower end (7.87" diameter) and extra space is allowed for the head at the wider end (9" diameter). A zip extends down the length of the bag, but also fully opens the top end of the bag, making it easier to get to your tripod. Thermoform padding holds the tripod in place and protects it, especially the head, during transport. Inner pocket holds accessories where they won't rattle around or get damaged. This bag can be hand-carried horizontally by the side handle, vertically by the end handle, or shoulder-carried using the included strap .....124.95

#### 39.3" Padded Tripod Bag (BOMBAG100P)

Same as MBAG120P, but slightly smaller ..109.95

#### 35.4" Padded Tripod Bag (BOMBAG90P)

Same as MBAG120P, but smaller .....99.95

#### 31.5" Padded Tripod Bag (BOMBAG80P)

Basically the same as MBAG120P, but smaller, without the side handle or inner accessory pocket. It is also narrower than the other padded bags. The narrow end measures 5.1" diameter, the wide end measures 5.9" .....74.95



End handle

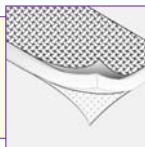

Padded bag

All padded bags feature 1680 Denier water proof super nylon, and an end handle. And with the exception of the 31.5" Padded Bag, they also feature a central handle and an internal pocket that holds a video head pan bar.



Central pocket



Internal pocket

### UNPADDED TRIPOD BAGS



#### 31.5" Unpadded Tripod Bag (BOMBAG80)

This unpadded tripod bag is slightly tapered to provide a better fit for your tripod with an attached head. The wider end of the bag accommodates the head without requiring all levers to be removed. It also features a zipper that extends down the length of the bag, but

also fully opens the top end of the bag. A logo end cap is padded to offer protection to the tripod head. This bag includes a shoulder strap .....49.95

#### 27.5" Unpadded Tripod Bag (BOMBAG70)

Same as MBAG80, but slightly smaller at 27.5" in length .....41.95

#### Mini Air Bag (BOMBAGD)

An unpadded rucksack-style bag for small tripods. It has a bungee cord top opening and adjustable straps, and comes in resistant nylon with printed Manfrotto logo .....15.95

## TRIPOD BAGS & CARRYING SYSTEMS



Straps can be removed and custom-positioned to better match the size of your tripod.



### Quick Action Strap (BO401N)

A quick and easy accessory for carrying your tripod when walking, hiking, cycling or just getting from shoot to shoot. Use the shorter straps to fasten the padded Quick Action Strap to one of the legs of your tripod, bind the remaining legs together using the longer adjustable quick release straps, sliding the tripod over your shoulder and you're ready to go, with your hands free to grab those vital last minute items. The padding helps hold the tripod in place and protects your back from bruises and chaffing. The Quick Action Strap even stays attached to your tripod when shooting (all you need to do is release the longer quick release straps so you can maneuver and position all three legs), so you're always ready to capture the images you want, but also always ready to move off again to the next location .....49.95



### LONG STRAPS

#### Long Grey Strap (BO3044)

A basic 2" wide strap to carry your kit. A spring clip fastens quickly to the steel ring at the shoulder of the tripod, and a closed loop goes around the feet of the tripod, to grip them securely. It features an adapter for compatibility with all Manfrotto tripods and comfortable rubberized fabric to avoid the tripod slipping on your shoulder .....29.95



#### Long Green Strap (BO102NAT)

Same as the above, but in green rubberized fabric to match the 3205GN3 and 3221GN3 tripods .....29.95



#### Apron Support (BO3146)

Attaches to the tripod legs and allows for storage space beneath the center column. It can also be used to hold a sandbag or stones for extra support. Fits most Manfrotto tripods.....28.95

### SHORT STRAPS

#### Short Grey Strap (BO3044TSB)

An adjustable length 2" wide strap with a single spring clip that attaches to the steel ring at the shoulder of your tripod. It features an adapter for compatibility with all Manfrotto tripods. Comfortable rubberized fabric keeps the tripod from slipping on your shoulder .....29.95

#### Short Green Strap (BO3044TSG)

Same as the above, but in green rubberized fabric to match the Manfrotto 3205GN3 and 3221GN3 tripods .....28.95

#### Short Black Strap (BO3044NAR)

A 1.5" wide adjustable strap supplied with an adapter and a special spring hook which makes attaching and detaching the strap from the tripod easy. It features a double-fixing system whereby the hook attaches to the tripod spider and loops around legs .....29.95

#### Carbon One Series

##### Carrying Strap (BO3447)

Adjustable length strap for Carbon One tripods. It is supplied with an adapter and a spring hook to easily attach and detach the strap. The strap has a single fixing system, the hook attaches to the tripod spider so that the tripod and head hang down your body. 1.57" width, black color .....29.50